

BERGER SURGICAL
M E D I C A L P R O D U C T S G M B H

Dieser Hauptkatalog bleibt ausschließlich unser Eigentum. Jeglicher Nachdruck, auch auszugsweise, ist strengstens verboten. Technische Änderungen vorbehalten. Unsere Allgemeinen Liefer- und Verkaufsbedingungen sind in der jeweils derzeit gültigen Preisliste zu finden.

This main catalog remains exclusively our property. Any reprinting, even in part, is strictly forbidden. Technical data is subject to change. Our General Delivery and Sales Conditions can be found in the respective, currently valid price list.



**Berger Surgical
Medical Products GmbH
Kirchstraße 22
D - 78532 Tuttlingen**

Germany

Telefon: +49 (0) 74 61/96 96-0
Telefax: +49 (0) 74 61/96 96-20
www.berger-surgical.de
info@berger-surgical.de





Unser Unternehmen befindet sich in Tuttlingen – seit Jahrzehnten die Heimat von „Know-How“ für die Herstellung von hochwertigen technologischen Instrumenten für das gesamte medizinische Spektrum. Hier arbeiten innovative Spezialisten mit ausgezeichneter Erfahrung.



Our company is located in Tuttlingen – For decades, it has been the home of „know-how“ for the production of high quality technological instruments for the entire medical spectrum. Here you will find the innovative specialists with outstanding experience.



Im Laufe der Jahre haben wir uns umfangreiche Erfahrungen und äußerst fundierte Fachkenntnisse auf dem Gebiet der Medizintechnik angeeignet, sodass wir qualifizierte und kompetente Empfehlungen zum Markt, insbesondere im Bezug auf Produkte, Methoden, Qualität, Preise und - nicht zuletzt – Lieferzeit geben können. Somit wollen wir Vertrauen und Verlässlichkeit mit unseren Partnern aufbauen. Wir sind ein erfahrenes, engagiertes und gewissenhaftes Team mit dem primären Ziel, unseren Kunden die bestmöglichen Lösungen anzubieten.

Unsere Produkte werden von exklusiv ausgewählten Spezialisten vertrieben, die regional präsent sind und daher jederzeit für Beratung und engagierte Unterstützung an Ort und Stelle ansprechbar sind. Partnerschaft kombiniert mit Kompetenz ist und bleibt auch in Zukunft das Wichtigste für uns und unsere Kunden.

Firmen-Philosophie

Vertrieb

Sortiment

Wir bieten eine breite Produktpalette, die chirurgischer Instrumente für alle medizinischen Disziplinen und minimalinvasive Chirurgie einschließt, dazu Behältersysteme für Sterilisation und Transport sowie Autoklavenendoskope und HF-Zubehör für universelle Anwendungen.

Selbstverständlich sind wir immer offen für Sonderanforderungen, Vorschläge für spezifische Ansprüche und individuell angefertigte Produkte. Darüber hinaus sind Reparaturen für uns keine Belastung, sondern sind eine Herausforderung, die für unser Geschäft unabdingbar ist.

Qualität

Wir legen großen Wert auf Qualität, weshalb der Großteil unserer Produkte in Tuttlingen hergestellt wird. Seit 1996 ist die Berger Surgical Medical Products GmbH nach EN ISO 13485 zertifiziert. Aus diesem Grund sind wir von der erstklassigen Qualität unserer Produkte überzeugt und bereit, eine Garantie von fünf Jahren für chirurgische Instrumente zu gewähren.

Service

Kundenorientierter Service, kurze Lieferzeiten, schnelle und kompetente Abwicklung sind zweifellos für uns von großer Bedeutung, wenn wir uns um Lösungen für die Anforderungen unserer Kunden bemühen. Unser Bestreben ist es, die höchsten Standards in unseren Innen- und Außendienstaktivitäten aufrechtzuerhalten und diese kontinuierlich zu optimieren.

Company-Philosophy

Over the years we have gained significant experience and profound expertise in the medical field, giving us the authority to make qualified and competent recommendations on the market especially in terms of products, methods, quality, prices and – last but not least – delivery time. We thus want to build up trust and confidence with our partners. We are a young and highly motivated, conscientious team with the primary objective to offer the best possible solutions to our customers.

Marketing

Our products are distributed by exclusively selected specialists who are regionally present and, therefore, always available to provide advice and committed assistance. Thus local partnership combined with competence is and will be most important for our customers and ourselves in the future.

We have a wide range of products including surgical instruments for all types of medical discipline, minimally invasive surgery, also container systems for sterilization and transport as well as autoclave endoscopes and HF accessories for universal applications.

Clearly we are always open to special individual requirements, proposals for specific demands and custom-made products. Furthermore, repairs are no burden for us but rather a challenging feature (oder idiosynkrasie) imperative for our business.

We put great emphasis on quality, the reason why the majority of our products are made in Tuttlingen. Since 1996 Berger Surgical Medical Products GmbH has been certified in accordance with EN ISO 13485. Therefore, we are convinced of the high quality of our products and are prepared to grant a five year guarantee on surgical instruments.

Customer orientated service, short delivery time, quick and competent execution are certainly of great importance to us when finding solutions for the requirements of our customers. Our endeavors are to uphold the highest standards in our home and field activities and to continuously update them.

Assortment

Quality

Service

**Grund-Instrumentarium
für alle Disziplinen einsetzbar**

- 00 Diagnostik
- 01 Scheren
- 02 TC-Scheren
- 03 Pinzetten
- 04 TC-Pinzetten
- 05 Klemmen
- 06 Wundhaken, Wundspreizer
- 07 Nadelhalter, Naht-Instrumente
- 08 TC-Nadelhalter

Instrumente nach Fachdisziplinen

- 11 Neuro-Instrumente
- 13 Augen-Instrumente
(Katalog auf Anfrage)
- 15 Mund- Kiefer u. Gesichtschirurgie
(Katalog auf Anfrage)
- 17 HNO-Hals und Nase
- 18 NO-Ohr Instrumente
- 19 Dental-Instrumente
(Katalog auf Anfrage)
- 21 Thorax, Lunge
- 23 Herz-Gefäß
- 25 Magen-Darm-Rektum
- 26 Leber-Galle-Niere
- 27 Gynäkologie- und Geburtshilfe
- 28 Urologie
- 30 MIC (Katalog auf Anfrage)
- 31 Knochenchirurgie
- 32 Kirschnerdrähte
- 34 Osteo-Synthese
(Katalog auf Anfrage)
- 40 Arthroskopie-Instrumente
(Katalog auf Anfrage)
- 41 Verband- und Gips-Instrumente
(Katalog auf Anfrage)

Sonstige Produkte

- 43 Nagel und Fußpflege
- 45 Behälter und Gefäße
- 46 Sterilisier-Container
(Katalog auf Anfrage)
- 47 Sterilisations-Zubehör
- 51 Akku-Bohrmaschine und Zubehör
(Katalog auf Anfrage)
- 55 Optiken und Zubehör
(Katalog auf Anfrage)
- 60 HF-Zubehör
(Katalog auf Anfrage)



**Standard Surgical Instruments
for all Disciplines**

- 00 Diagnostics
- 01 Scissors
- 02 TC-Scissors
- 03 Forceps
- 04 TC-Forceps
- 05 Forceps, Clamps, Clips
- 06 Retractors, Spreaders
- 07 Needle Holders, Suture Instruments
- 08 TC-Needle Holders

Instruments for Special Disciplines

- 11 Neuro Surgery
- 13 Ophthalmology
(Special catalogue)
- 15 Mouth, Jaw and Maxillo Facial Surgery
(Special catalogue)
- 17 ENT - Nose and Throat
- 18 ENT - Ear Instruments
- 19 Dental
(Special catalogue)
- 21 Thorax, Lungs
- 23 Cardiovascular Surgery
- 25 Stomach, Intestine, Rectum
- 26 Liver, Gall Bladder, Kidney
- 27 Gynecology, Obstetrics
- 28 Urology
- 30 Minimal Invasive Surgery (MIS)
(Special catalogue)
- 31 Bone Surgery
- 32 Kirschner Wires
- 34 Osteosynthesis Products
(Special catalogue)
- 40 Arthroscopy
(Special catalogue)
- 41 Dressing and Cast Instruments
(Special catalogue)

Other Products

- 43 Nail and Ward Instruments
- 45 Bowls, Containers, Trays
- 46 Steril-Container
(Special catalogue)
- 47 Sterilizing Accessories
- 51 Battery-Driven Drill and Accessories
(Special catalogue)
- 55 Scopes and Accessories
(Special catalogue)
- 60 Accessories for High frequency
Surgery
(Special catalogue)



Diagnostik
Diagnostics

00

Seite/Page 1 - 32

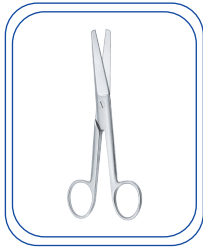

Scheren
Scissors

01

Seite/Page 33 - 67



TC - Scheren
TC - Scissors

02

Seite/Page 69 - 83

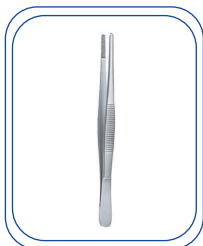

Pinzetten
Forceps

03

Seite/Page 85 - 109

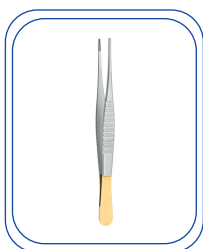

TC-Pinzetten
TC-Forceps

04

Seite/Page 111 - 114



Klemmen
Forceps, Clamps, Clips

05

Seite/Page 116 - 184



Wundhaken
Retractors

06

Seite/Page 186 - 246



**Nadelhalter,
Nahtinstrumente**
Needle Holders,
Suture Instruments

07

Seite/Page 247 - 262

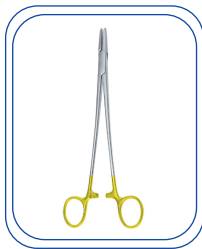

TC-Nadelhalter
TC Needle Holders

08

Seite/Page 264 - 280



NEURO
NEURO

11

Seite/Page 282 - 296

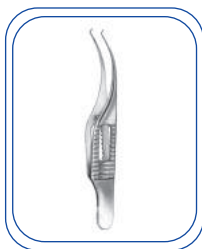

Augen-Instrumente
EYE Instruments

13

Katalog auf Anfrage
Special catalogue



**Mund-, Kiefer- und
Gesichtschirurgie**
Mouth, Jaw and
Maxillo Facial Surgery

15

Katalog auf Anfrage
Special catalogue



HNO-Hals und Nase
ENT - Nose and Throat

17

Seite/Page 298 - 332



HNO-Ohr Instrumente
ENT - Ear Instruments

18

Seite/Page 334 - 355

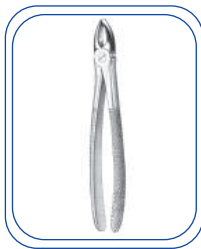

Dental
Dental

19

Katalog auf Anfrage
Special catalogue

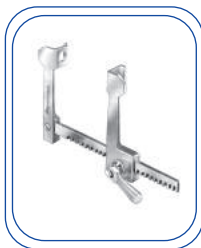

Thorax- und Lungeninstrumente
Thorax and Lung Instruments

21

Seite/Page 358 - 377

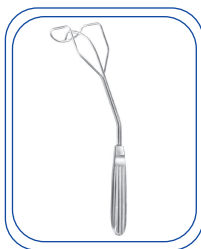

Herz-Gefäß
Cardiovascular

23

Seite/Page 380 - 397



Magen-Darm-Rektum
Stomach Intestinal Rectum

25

Seite/Page 400 - 418

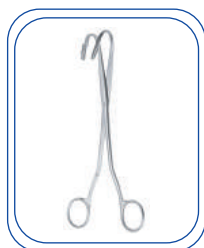

Leber-Galle-Niere
Liver, Gall Bladder, Kidney

26

Seite/Page 420 - 424



Gynäkologie
Gynecology

27

Seite/Page 426 - 457

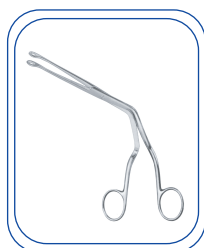

Urologie
Genito-Urinary

28

Seite/Page 460 - 465



MIC
Minimal-Invasive

30

Katalog auf Anfrage
Special catalogue



Knochenchirurgie
Bone Surgery

31

Seite/Page 468 - 547

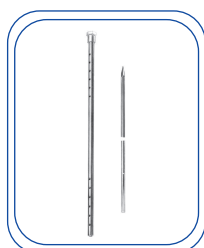

Kirschner Drähte
Kirschner Wire

32

Seite/Page 551 - 553



Arthroskopie-Instrumente
Arthroscopy

40

Katalog auf Anfrage
Special catalogue



Verband- und Gips instrumente
Bandage and Cast Instruments

41

Seite/Page 555 - 564
Und
Katalog auf Anfrage
Special catalogue



Nagel und Fußpflege
Nail and Care Instruments

43

Seite/Page 567 - 571



Schüsseln, Schalen Dosen
Bowls, Dishes, Containers

45

Seite/Page 573 - 576



Sterilisier-Container
Steril-Container

46

Katalog auf Anfrage
Special catalogue



Sterilisaion
Sterilization

47

Seite/Page 579 - 580



**Akku-Bohrmaschine
und Zubehör**
Battery-Driven Drill
and Accessories

51

Katalog auf Anfrage
Special catalogue



Optiken und Zubehör
Scopes and Accessories

55

Katalog auf Anfrage
Special catalogue



HF-Zubehör
HF Accessories

60

Katalog auf Anfrage
Special catalogue

**Weitere Gruppen sind
in Vorbereitung**

Further groups are
in preparation

Diagnostik
Diagnostics

00





Buck
18,0 cm **00-000-18**



Dejerine
20,0 cm **00-001-20**



Dejerine, mit Nadel / with needle
20,0 cm **00-002-21**



Taylor
17,0 cm **00-003-17**
20,0 cm **00-003-20**



Berliner
17,0 cm **00-004-17**



Troemner
23,0 cm **00-005-24**



Babinsky
22,0 cm **00-006-22**



Rabiner
23,0 cm **00-006-23**



Holz
wooden

Pinard
18,0 cm 00-010-01



Alu

Pinard
15,0 cm 00-010-02

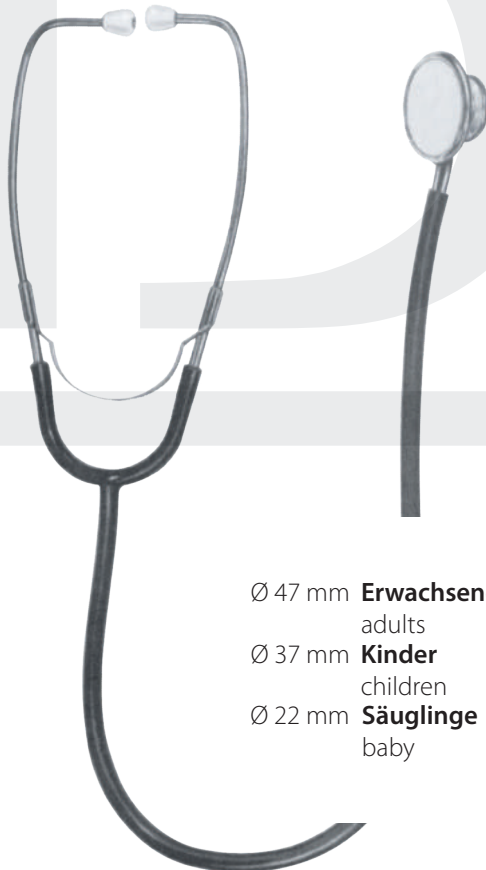

Ø 47 mm **Erwachsene** 00-012-01
adults
Ø 37 mm **Kinder** 00-012-02
children
Ø 22 mm **Säuglinge** 00-012-03
baby

Duplex Stethoskop



00-013-00 **Stethoskop**
Silber, Ø 47 mm



Sensibilisierungs-Rädchen
Sensitization-pinwheel

Wartenberg
18,0 cm 00-015-18

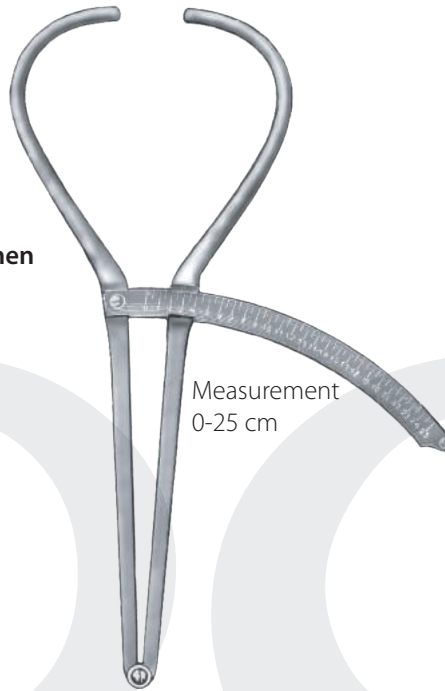

Measurement
0-25 cm

Bertillion Cephalometer
32,0 cm 00-020-01



Moeltgen Goniometer
00-021-01

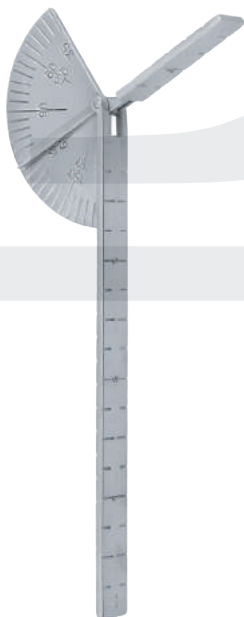

Caroll Finger-Goniometere
14,0 cm 00-022-14



Collin Dynamometer
12,0 cm 00-024-01 Erwachsene
adults
12,0 cm 00-024-02 Kinder
children



Metall Messstab
Rulers, Metal

- 10,0 cm **00-032-10**
- 15,0 cm **00-032-15**
- 20,0 cm **00-032-20**
- 30,0 cm **00-032-30**
- 50,0 cm **00-032-50**
- 100,0 cm **00-032-99**



Metall Messstab (röntgenfähig)
Rulers, Metal (x-ray)

- 50,0 cm **00-033-50**



Schieblehre
Caliper of Steel
00-036-15



Impflanzette
Vaccination lanzet
12,0 cm **00-042-12**



Stirnspiegel, komplett
Head mirror, complete
00-044-01



Stirnreifen, schwarz
Headband, black
00-044-10

Stirnreifen, weiß
Headband, white
00-044-11

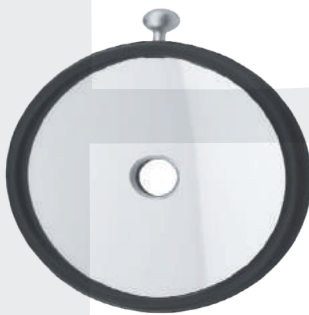

Stirnspiegel
Head mirror
Ø 90mm 00-044-98



Stirnlampe, 6 Volt
Head lights, 6 Volt
00-048-06



Birne, 6 Volt
Spare bulb, 6 Volt
00-048-26



Spiegel aus Glas
Mirror of glass
Ø 55mm 00-048-99

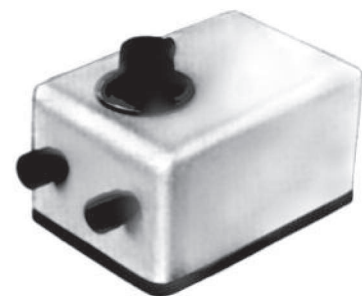

Transformator, 220 Volts
Transformer, 220 Volts
00-049-00

Warmlicht
Warm light

Kaltlicht
Fiberoptic

Miller

Nutzlänge

working length

- 55 mm Fig. 0 **00-051-00**
- 80 mm Fig. 1 **00-051-01**
- 130 mm Fig. 2 **00-051-02**
- 170 mm Fig. 3 **00-051-03**
- 180 mm Fig. 4 **00-051-04**



- 00-055-00**
- 00-055-01**
- 00-055-02**
- 00-055-03**
- 00-055-04**

Mc Intosh

Nutzlänge

working length

- 55 mm Fig. 0 **00-052-00**
- 70 mm Fig. 1 **00-052-01**
- 90 mm Fig. 2 **00-052-02**
- 110 mm Fig. 3 **00-052-03**
- 130 mm Fig. 4 **00-052-04**



- 00-054-00**
- 00-054-01**
- 00-054-02**
- 00-054-03**
- 00-054-04**

Wisconsin-Foregger

- 75 mm Fig. 00 **00-053-00**
- 90 mm Fig. 0 **00-053-01**
- 110 mm Fig. 1 **00-053-02**
- 140 mm Fig. 2 **00-053-03**
- 170 mm Fig. 3 **00-053-04**



Warmlicht
Warm light

Kaltlicht
Fiberoptic



Ersatzbirne, klein
Spare bulb, small
00-063-11

Ersatzbirne, groß
Spare bulb, big
00-063-12



Ersatzbirne, halogen
Spare bulb, fiberoptic
00-066-11

Batteriegriff
Battery handle
Ø 18 mm, **00-060-00**

Batteriegriff
Battery handle
Ø 30 mm, **00-062-00**

Batteriegriff
Battery handle
Ø 18 mm, **00-064-00**

Batteriegriff
Battery handle
Ø 30 mm, **00-065-00**

Sätze Warmlicht
Set Warm light

Sätze Kaltlicht
Set Fiberoptic

Miller



00-073-00
bestehend aus:
consisting of:
1 Griff (handle) **00-062-00**
je 1 Spatel (spatula) Fig. 1-2

00-074-00
bestehend aus:
consisting of:
1 Griff (handle) **00-062-00**
je 1 Spatel (spatula) Fig. 1-4
1 Etui/case

00-083-00
bestehend aus:
consisting of:
1 Griff (handle) **00-065-00**
je 1 Spatel (spatula) Fig. 1-2

00-084-00
bestehend aus:
consisting of:
1 Griff (handle) **00-065-00**
je 1 Spatel (spatula) Fig. 1-4
1 Etui/case

Mc Intosh



00-076-00
bestehend aus:
consisting of:
1 Griff (handle) **00-062-00**
je 1 Spatel (spatula) Fig. 1-3

00-077-00
bestehend aus:
consisting of:
1 Griff (handle) **00-062-00**
je 1 Spatel (spatula) Fig. 1-4
1 Etui/case

00-081-00
bestehend aus:
consisting of:
1 Griff (handle) **00-064-00**
je 1 Spatel (spatula) Fig. 1-3

00-082-00
bestehend aus:
consisting of:
1 Griff (handle) **00-064-00**
je 1 Spatel (spatula) Fig. 1-4
1 Etui/case

Wisconsin-Foregger



00-079-00
bestehend aus:
consisting of:
1 Griff (handle) **00-062-00**
je 1 Spatel (spatula) Fig. 0-3
1 Etui/case

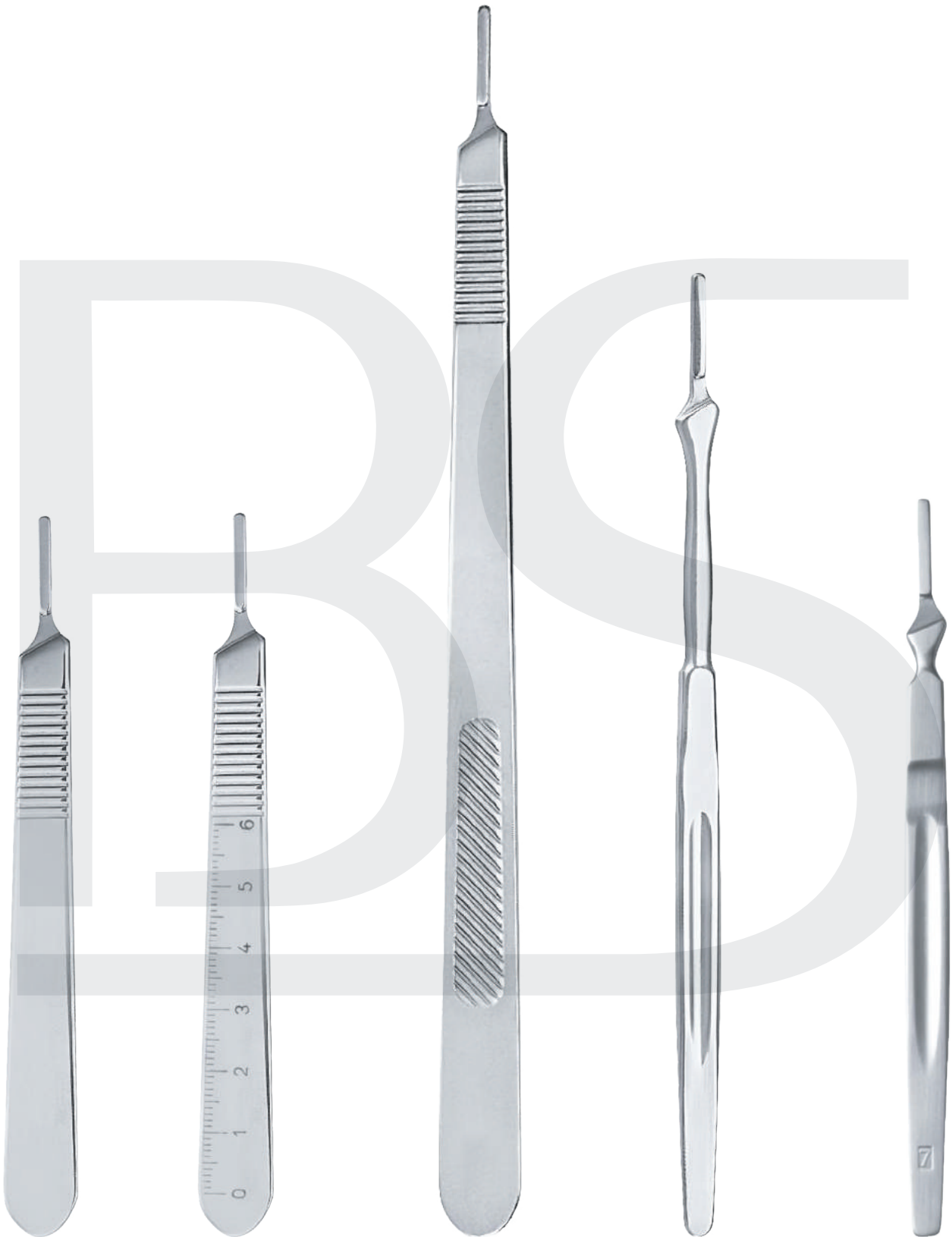

Standard, Nr. 3
00-103-01

Nr. 3
00-103-03

Nr. 4 L
00-103-04

Nr. 7
00-103-06

Nr. 7 K
00-103-07



Standard, Nr. 3 und 4
00-104-00

Standard, Nr. 4
00-104-01

Nr. 3 und 4
00-104-04

Collin, Nr. 8
00-104-06

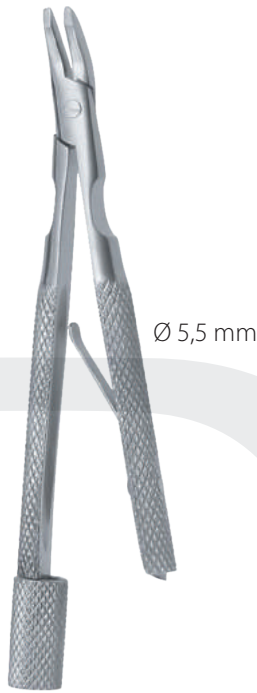

Troutman-Christ
10,0 cm **00-110-10**



Troutman-Christ
10,0 cm **00-111-10**



Castroviejo-Klingenhalter mit Sperre
Castroviejo-Blade with ratchet
11,0 cm **00-112-11**



Klingenbrecher u. -halter
Blade Breaker and Holder
00-114-13

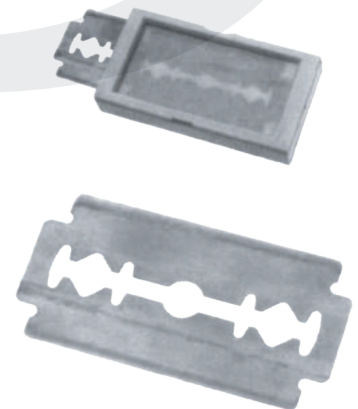

Klingen Pack. = 10 Klingen
Blades Pack. = 10 Blades
00-116-00



Fig. 10
00-153-10



Fig. 11
00-153-11



Fig. 12
00-153-12



Fig. 15
00-153-15

Passend für
Useable for
00-103-01
00-103-03
00-103-04
00-103-06
00-103-07
00-104-00

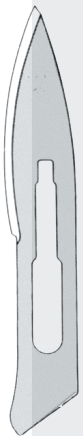

Fig. 18
00-153-18



Fig. 19
00-153-19

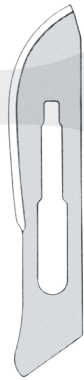

Fig. 20
00-153-20



Fig. 21
00-153-21



Fig. 22
00-153-22



Fig. 23
00-153-23

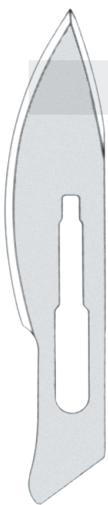

Fig. 24
00-153-18

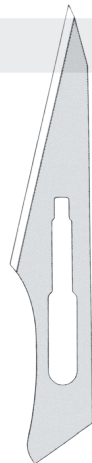

Fig. 25
00-153-25



Fig. 36
00-153-36

Passend für
Useable for
00-104-00
00-104-01
00-104-04
00-104-06

1 Pack. = 100 Stck/pieces



16,0 cm

Fig. 1
00-310-01

Fig. 2
00-310-02

Fig. 3
00-310-03

Fig. 4
00-310-04

Fig. 5
00-310-05

Fig. 6
00-310-06

Fig. 7
00-310-07

Fig. 8
00-310-08

Fig. 9
00-310-09

Fig. 10
00-310-10

Anatomische Skalpelle

beidseitig schneidend
cutting edge both sides

beidseitig schneidend
cutting edge both sides

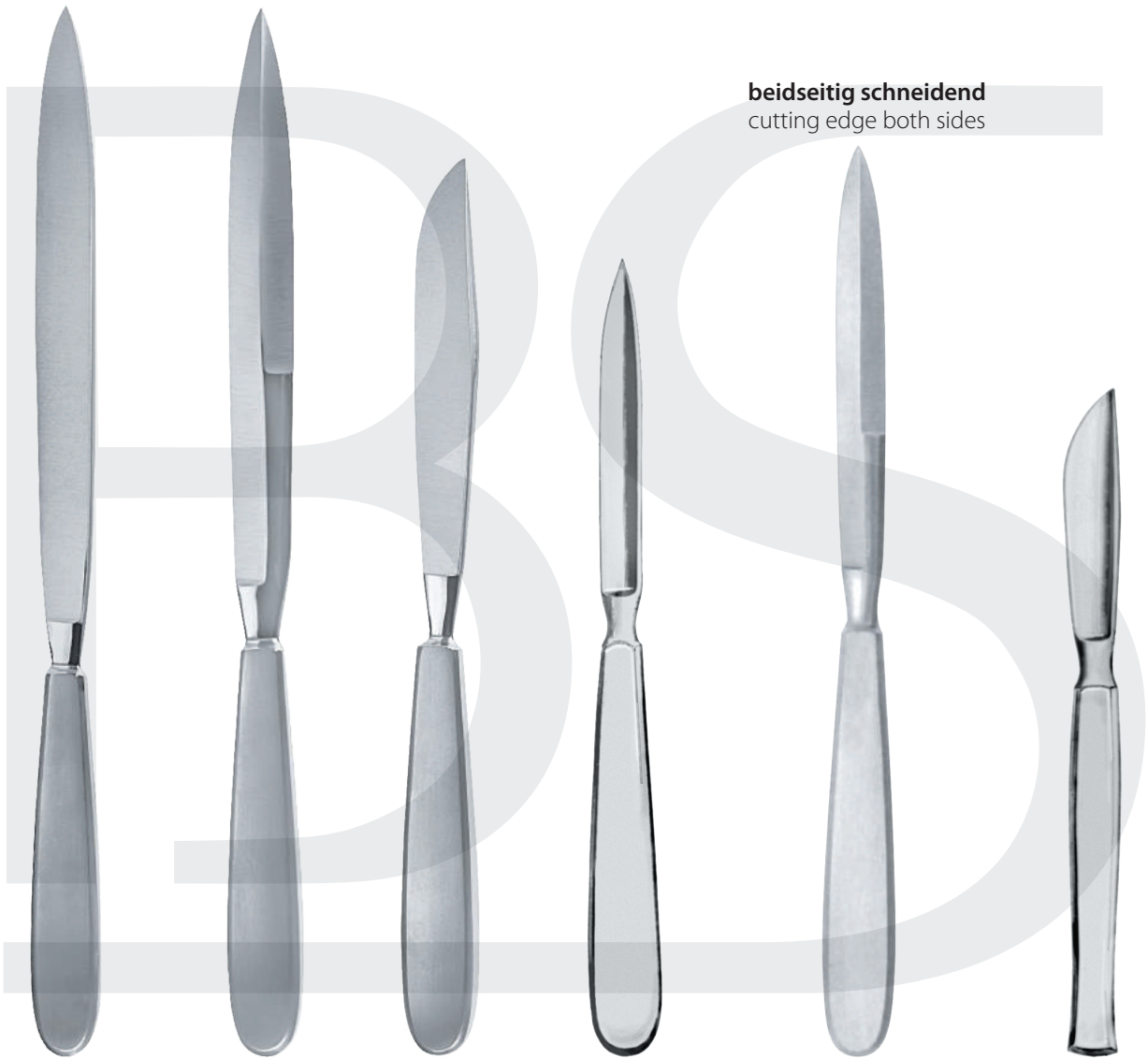

Liston

Catlin

Langenbeck

Phalangenmesser

Zwischenknochenmesser

Beinhautmesser

S=13 cm **00-320-13**
S=16 cm **00-320-16**
S=19 cm **00-320-19**
S=22 cm **00-320-22**

00-322-16
S=16 cm

00-324-12
S=12 cm

Phalangeal knife
00-326-10
S=10,5 cm

Interosseous knife
00-328-11
S=10,5 cm

Periosteum knife
00-330-06
S=6,5 cm
mit Schaber
with raspatory

S=Schnitlänge
S=length of blades



Langenbeck Fig. 1
S=5,5 cm **00-332-01**

Langenbeck Fig. 2
S=5,5 cm **00-332-02**

Knorpelmesser
Cartilage knife
S=5,5 cm **00-334-01**
mit Schaber
with raspatory

Holzheft
Wooden handle

Knorpelmesser
Cartilage knife
S=7,0 cm **00-334-02**

Virchow
S=8,5 cm **00-338-08**
mit Schaber
with raspatory

S=Schnittlänge
S=length of blades

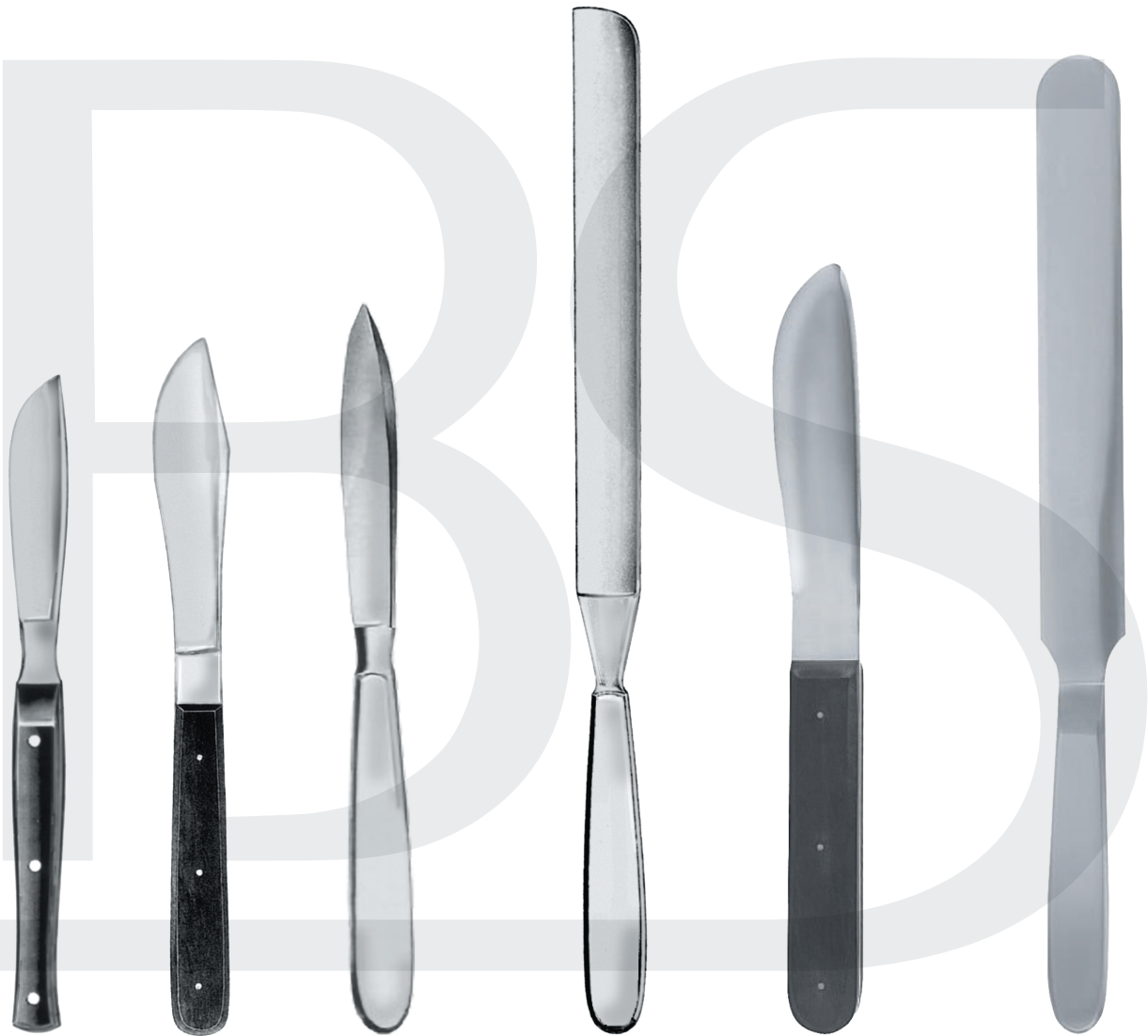

Virchow Holzheft

Wooden handle

00-340-09

S=9,5 cm

Virchow

00-340-11

S=11,5 cm

Seziermesser

Autopsy knife

S=10,0 cm **00-344-10**

S=13,0 cm **00-344-13**

Seziermesser

Autopsy knife

00-344-19

S=19,5 cm

Organmesser

Post mortem knife

S=11,0 cm **00-350-11**

S=14,0 cm **00-350-14**

S=17,0 cm **00-350-17**

Virchow Hirnmesser

Brain knife

S=16,0 cm **00-360-16**

S=20,0 cm **00-360-20**

S=24,0 cm **00-360-24**

S=Schnittlänge

S=length of blades



Simon 20.0 cm



Fig. 1
00-362-01



Fig. 2
00-362-02



Fig. 3
00-362-03



Schädelspalter
Skull Breaker
14,0 cm 00-384-14



Ulrich
22,5 cm 00-364-22



Ayre
22,5 cm 00-365-23



Segond
27,0 cm 00-368-27

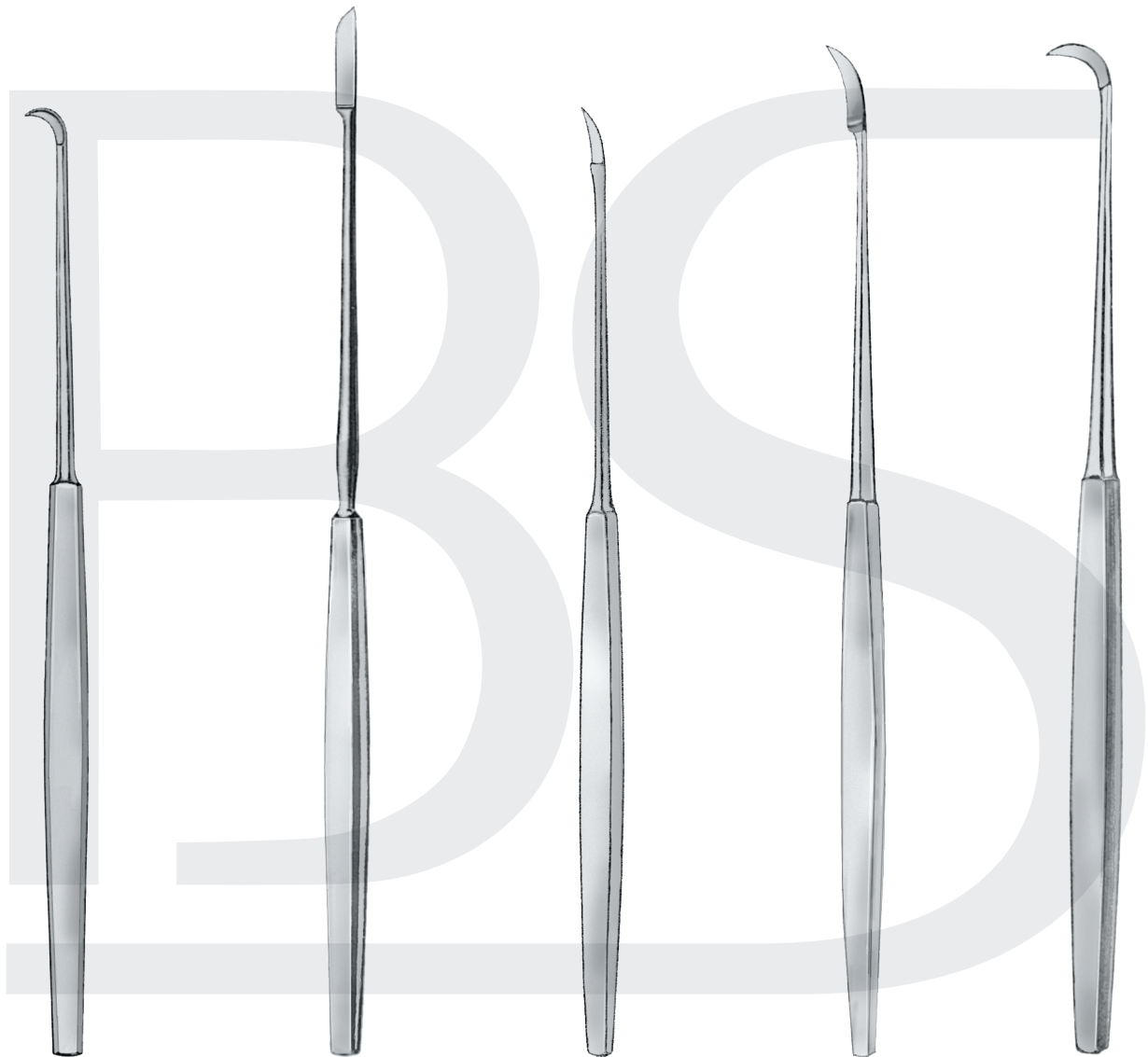

Olivecrona
Trigeminusmesser
Trigeminal knife
20,0 cm **00-369-20**

Trigeminusmesser
Trigeminal knife
23,0 cm **00-370-23**

Fowler
Tonsillenmesser
Tonsil knife
20,0 cm **00-371-20**

Abraham
Tonsillenmesser
Tonsil knife
21,5 cm **00-371-21**

Brünings
Tonsillenmesser
Tonsil knife
21,5 cm **00-371-22**

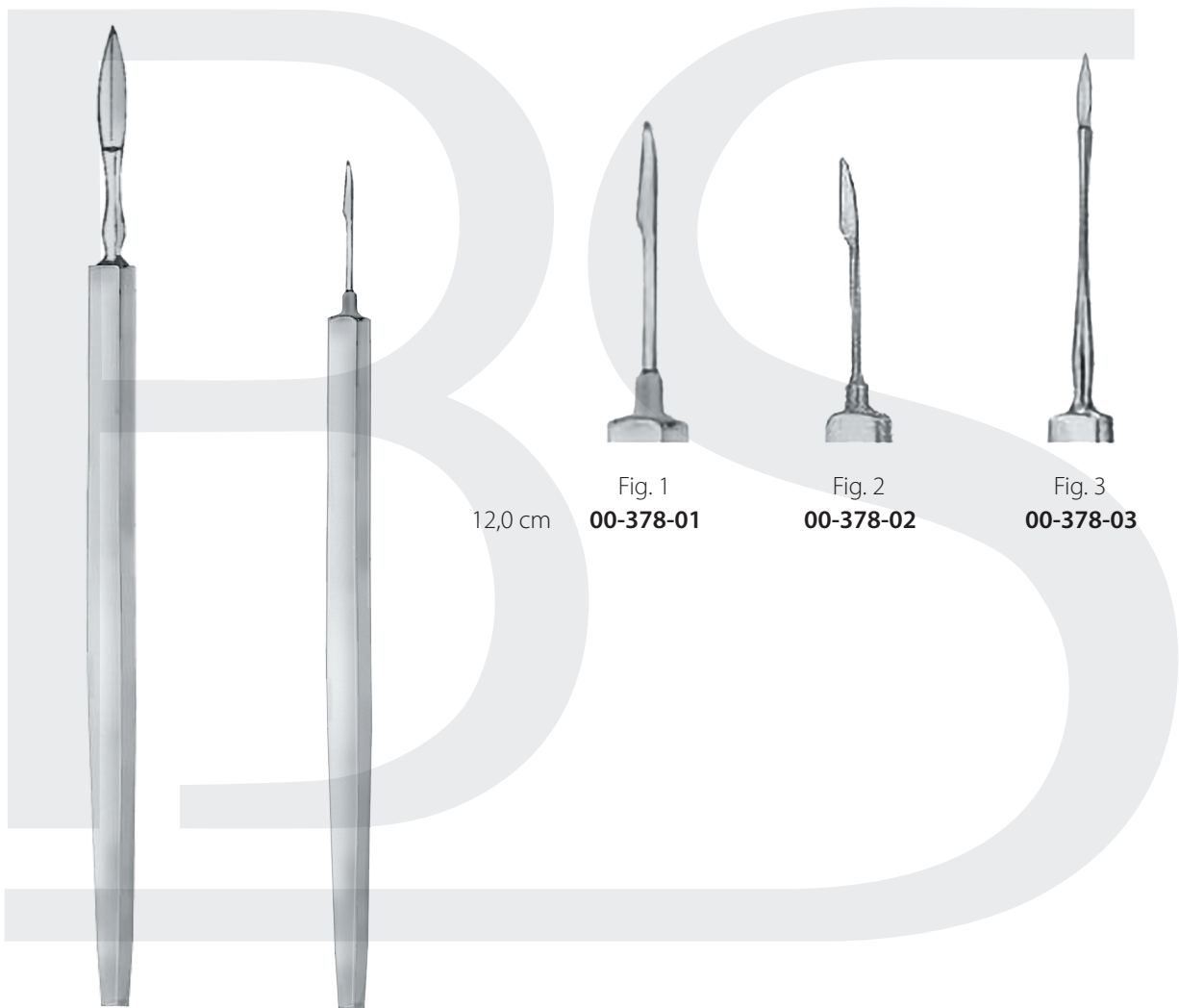

Abszeßmesser
Abscess knife
13,0 cm **00-374-13**



Ziegler Duramesser
Dura knife

12,0 cm



Fig. 1
00-378-01



Fig. 2
00-378-02



Fig. 3
00-378-03



**Schink
Dermatom, kompl.**
Dermatome, complete
30,0 cm **00-400-00**



Ersatzklinge
Spare blade
00-400-01



Spannplatte
Skin straightening plate
00-400-02



**Silver
Dermatom**
Dermatome
19,0 cm **00-402-19**



Humby
32,0 cm **00-406-30**



Rasiermesser
Razor
S=8,0 cm **00-409-00**

S=Schnittlänge
S=length of blades



Ersatzklinge
Spare blade
00-410-99



Vidal Lupusschaber
Lupus scraper
14,0 cm 00-411-14



Fox Lupusschaber
Lupus scraper
14cm



Ø 3 mm 00-412-03



Ø 4 mm 00-412-04



Ø 5 mm 00-412-05



Ø 6 mm 00-412-06



Wolff Lupusschaber
Lupus scraper
14cm



Fig. 1
00-414-01



Fig. 3
00-414-03



Fig. 5
00-414-05



Fig. 2
00-414-02



Fig. 4
00-414-04



Fig. 6
00-414-06

Monocorps Milienmesser
Milium knife
14,0 cm 00-410-14

Ø 2 mm
00-420-02

Ø 3 mm
00-420-03

Ø 5 mm
00-420-05

Ø 7 mm
00-420-07

Ø 4 mm
00-420-04

Ø 6 mm
00-420-06

Ø 8 mm
00-420-08



Keyes Hautstanze
Dermal punch
12cm

Trephinensatz komplett auf Platte mit Griff und 6 auswechselbaren Trephinen 2-7mm

Punch Set complete on plate with handle and 6 exchangeable Punches 2-7mm

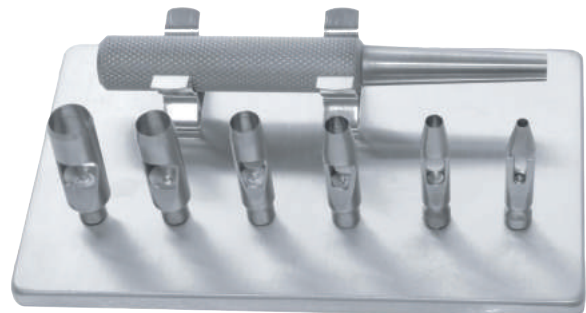

Keyes Satz komplett
Set complete
00-422-00

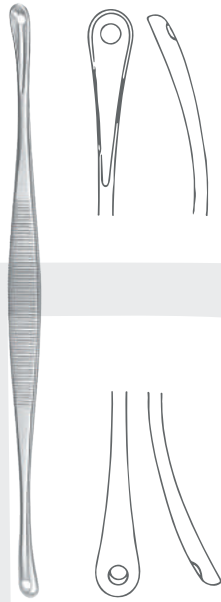

Unna

14,0 cm **00-431-14**



Unna

14,0 cm **00-433-14**



Saalfeld

11,0 cm **00-435-11**

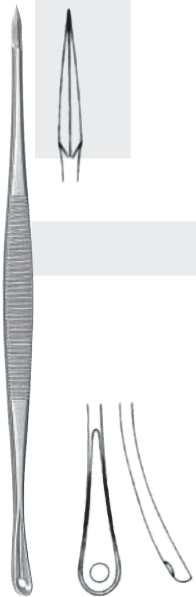

Saalfeld

14,0 cm **00-437-14**



Schamberg

10,0 cm **00-439-09**



Katsch

14,0 cm **00-441-14**



Unna-Vidal

11,5 cm **00-446-11**



Knopfsonde
Probes

	Ø 1,0 mm	Ø 1,5 mm	Ø 2,0 mm
11,5 cm	00-600-11	00-601-11	00-602-11
13,0 cm	00-600-13	00-601-13	00-602-13
14,5 cm	00-600-14	00-601-14	00-602-14
16,0 cm	00-600-16	00-601-16	00-602-16
18,0 cm	00-600-18	00-601-18	00-602-18
20,0 cm	00-600-20	00-601-20	00-602-20
25,0 cm	00-600-25	00-601-25	00-602-25



Knopfsonde mit Ohr
Probes with eye

	Ø 2,0 mm
11,5 cm	00-604-11
13,0 cm	00-604-13
14,5 cm	00-604-14
16,0 cm	00-604-16
18,0 cm	00-604-18
20,0 cm	00-604-20



Myrtenblattsonde
Myrtle leaf probes

	Ø 2,0 mm
13,0 cm	00-606-13
14,5 cm	00-606-14
16,0 cm	00-606-16
20,0 cm	00-606-20



Stacke

	Ø 1,0 mm
10,5 cm	00-608-10



Bowman
geknöpft

Fig.	
00/0	00-609-01
1/2	00-609-02
3/4	00-609-03
5/6	00-609-04



Hohlsonde
Directors

11,5 cm	00-610-11
13,0 cm	00-610-13
14,5 cm	00-610-14
16,0 cm	00-610-16
18,0 cm	00-610-18



Hohlsonde mit Knopf
Directors with tip

	Ø 3,3 mm
13,0 cm	00-612-13
14,5 cm	00-612-14
16,0 cm	00-612-16



Doyen

14,5 cm	00-613-14
---------	------------------



Nélaton

16,0 cm	00-615-16
---------	------------------



Brodie
Ø 3,5 mm
20,0 cm **00-616-20**



Lockhart-Mummery
16,0 cm **00-618-16**



Lockhart-Mummery
16,0 cm **00-619-16**



Lockhart-Mummery
16,0 cm **00-621-16**



Lockhart-Mummery
16,0 cm **00-623-16**



Ritter Stirnhöhrendilatator
Frontal Sinus Bougies
Ø 2,5 mm **00-625-25**
Ø 3,0 mm **00-625-30**
Ø 4,0 mm **00-625-40**
Ø 5,0 mm **00-625-50**



Farrell
Ø 0,9 mm 12 cm **00-630-12**
Ø 0,9 mm 14 cm **00-630-14**
Ø 1,1 mm 16 cm **00-630-16**
Ø 1,2 mm 18 cm **00-630-18**



Universal
Ø 1,0 mm 12 cm **00-632-12**
Ø 1,0 mm 14 cm **00-632-14**
Ø 1,2 mm 16 cm **00-632-16**
Ø 1,2 mm 18 cm **00-632-18**



Jobson-Horne
18,0 cm **00-636-18**

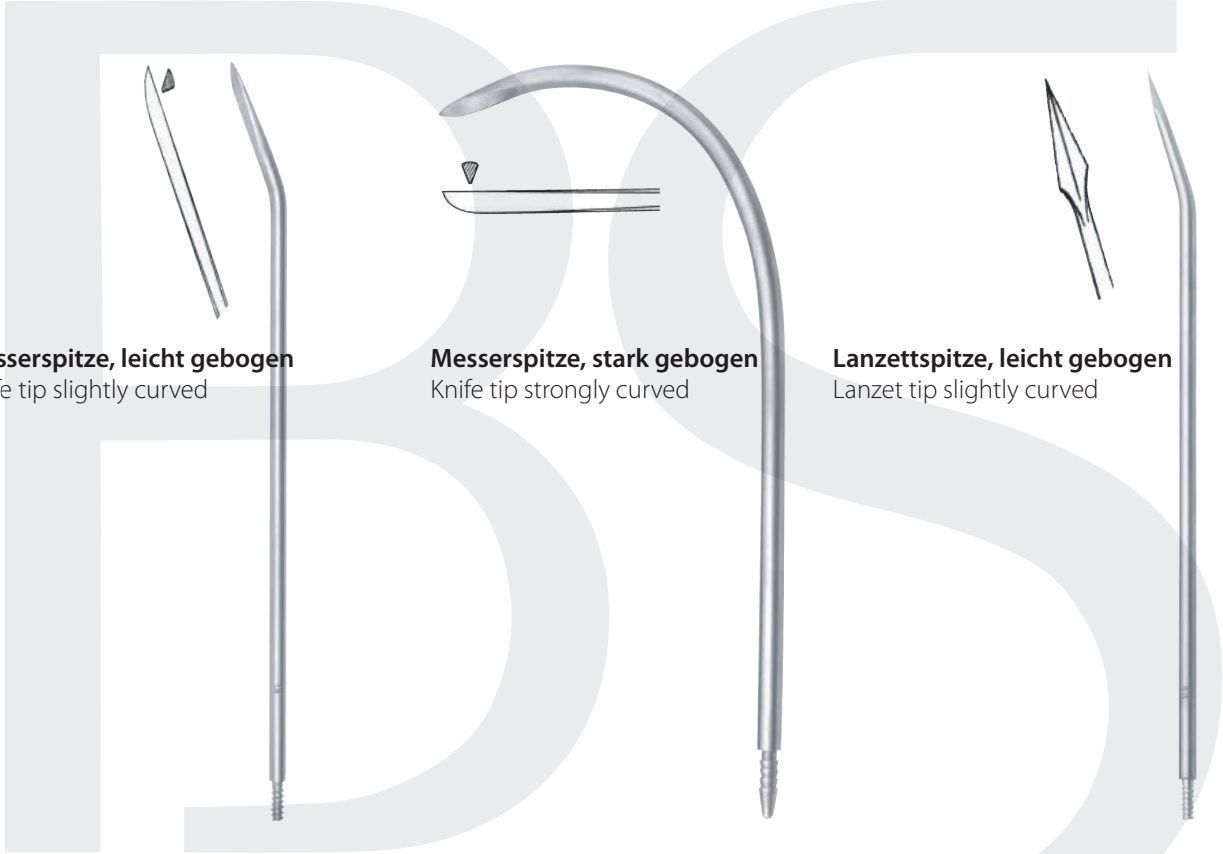

Messerspitze, leicht gebogen
Knife tip slightly curved

Messerspitze, stark gebogen
Knife tip strongly curved

Lanzettspitze, leicht gebogen
Lanzet tip slightly curved

Charr. Screw end

8	00-703-08
10	00-703-10
12	00-703-12
14	00-703-14
16	00-703-16
18	00-703-18

Charr. Screw end

8	00-707-08
10	00-707-10
12	00-707-12
14	00-707-14
16	00-707-16
18	00-707-18

Charr. Screw end

8	00-711-08
10	00-711-10
12	00-711-12
14	00-711-14
16	00-711-16
18	00-711-18



Universal

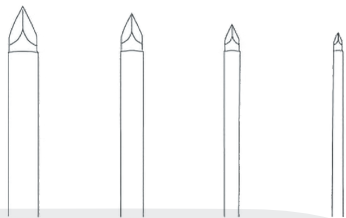

Satz zu 3 St.
Set of 3 pieces
Ø 1,75 - 4,5 mm **00-720-03**

Satz zu 4 St.
Set of 4 pieces
Ø 1,75 - 6,0mm **00-720-04**



Standard

12,0 cm
Ø 3 mm **00-722-03**
Ø 4 mm **00-722-04**
Ø 5 mm **00-722-05**
Ø 6 mm **00-722-06**



Nelson

12,0 cm
Ø 3,0 mm **00-724-03**
Ø 4,0 mm **00-724-04**
Ø 5,0 mm **00-724-05**
Ø 6,0 mm **00-724-06**
Ø 6,5 mm **00-724-07**
Ø 7,5 mm **00-724-08**
Ø 9,0 mm **00-724-09**
Ø 10,5 mm **00-724-10**
Ø 12,0 mm **00-724-12**
Ø 13,5 mm **00-724-13**
Ø 14,5 mm **00-724-14**
Ø 15,5 mm **00-724-15**



Sinoskopie
Ø 3,5 mm **00-726-35**



Buelau
Ø 8,0 mm **00-728-08**
Ø 10,0 mm **00-728-10**



Lichtwitz
Ø 1,75 mm
19,0 cm **00-730-18**



Pierce
Ø 4,0 mm
16,0 cm **00-731-04**



Krause
Ø 4,0 mm
16,0 cm **00-733-04**



Duke
Ø 5,5 mm
11,0 cm **00-734-05**



Ochsner
14,0 cm
Ø 4,0 mm **00-736-40**
Ø 4,6 mm **00-736-46**
Ø 5,3 mm **00-736-53**
Ø 6,0 mm **00-736-60**



Landau
Ø 2,0 mm
16,0 cm **00-738-02**



Douglas
Ø 3,0 mm
11,0 cm **00-739-03**



Coakley
Ø 2,3 mm
14,0 cm **00-741-03**



Pudendus-Kanüle
Pudendus Needle

14,0 cm **00-802-00**



Venenkanüle
Vein Needle

80 mm
1,20 mm **00-804-12**
1,50 mm **00-804-15**



gerade
straight



gebogen
curved



abgewinkelt
angled



bajonett
bayonet

Tonsillenkanülen
Tonsil Needles

Ø 0,8 mm **00-810-01** **00-810-02** **00-810-03** **00-810-05**

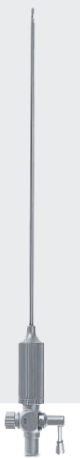

Verres

Ø 2,0 mm

80 mm **00-812-08**
100 mm **00-812-10**
120 mm **00-812-12**
130 mm **00-812-13**
140 mm **00-812-14**
150 mm **00-812-15**



Menghini

Ø 1,0x 35 mm **00-814-01**
Ø 1,0x 70 mm **00-814-02**
Ø 1,2x 70 mm **00-814-03**
Ø 1,2x 100 mm **00-814-04**
Ø 1,4x 70 mm **00-814-05**
Ø 1,4x 100 mm **00-814-06**
Ø 1,6x 70 mm **00-814-07**
Ø 1,8x 100 mm **00-814-08**



Menghini

Ø 1,4 x 168 mm **00-816-14**
Ø 1,8 x 168 mm **00-816-18**



Vollmar

Ø 1,5 mm **00-817-15**
Ø 2,0 mm **00-817-20**
Ø 2,5 mm **00-817-25**
Ø 3,0 mm **00-817-30**
Ø 4,0 mm **00-817-40**



Vollmar

Ø 1,5 mm **00-817-15**
Ø 2,0 mm **00-817-20**
Ø 2,5 mm **00-817-25**
Ø 3,0 mm **00-817-30**
Ø 4,0 mm **00-817-40**



Mock

1,5 mm x 8,0 cm **00-820-08**



Luer-Lock

- 2 ml **00-848-02**
- 5 ml **00-848-05**
- 10 ml **00-848-10**
- 20 ml **00-848-20**



Janet

- 50 ml **00-860-05**
- 100 ml **00-860-10**
- 200 ml **00-860-20**



00-900-00

komplett, bestehend aus:
complete, consisting of:

- 00-900-01 Absaugrohr/suction tube, 14,0 cm**
- 00-900-04 Kanüle/cannula Ø 0,4 mm**
- 00-900-06 Kanüle/cannula Ø 0,6 mm**
- 00-900-08 Kanüle/cannula Ø 0,8 mm**



Ø 0,4



Ø 0,6



Ø 0,8

Wullstein



Frazier Saugrohr
Frazier Suction Tube
00-902-21

Arbeitslänge working length	9,0 cm	11,0 cm	13,0 cm	15,0 cm	19,0 cm	25,0 cm
Ø 1,2 mm	00-902-21	00-902-31	00-902-41	00-902-51	00-902-61	00-902-71
Ø 1,5 mm	00-902-22	00-902-32	00-902-42	00-902-52	00-902-62	00-902-72
Ø 2,0 mm	00-902-23	00-902-33	00-902-43	00-902-53	00-902-63	00-902-73
Ø 2,3 mm	00-902-24	00-902-34	00-902-44	00-902-54	00-902-64	00-902-74
Ø 2,5 mm	00-902-25	00-902-35	00-902-45	00-902-55	00-902-65	00-902-75
Ø 3,0 mm	00-902-26	00-902-36	00-902-46	00-902-56	00-902-66	00-902-76
Ø 3,3 mm	00-902-27	00-902-37	00-902-47	00-902-57	00-902-67	00-902-77
Ø 3,5 mm	00-902-28	00-902-38	00-902-48	00-902-58	00-902-68	00-902-78
Ø 4,0 mm	00-902-29	00-902-39	00-902-49	00-902-59	00-902-69	00-902-79
Ø 5,0 mm	00-902-30	00-902-40	00-902-50	00-902-60	00-902-70	00-902-80



Plester

	19,5 cm
1,5 mm	00-903-04
2,0 mm	00-903-06
2,5 mm	00-903-07
2,7 mm	00-903-08
3,0 mm	00-903-09
3,3 mm	00-903-10
3,6 mm	00-903-11
4,0 mm	00-903-12
5,0 mm	00-903-15



Adson

	21,0 cm
Ø 4,0 mm	00-905-04



Ø 8 mm



Cooley
35,0 cm **00-917-08**

Ø 10 mm



Cooley
31,0 cm **00-919-10**

Ø 7 mm



Cooley
30,0 cm **00-921-07**

Ø 8 mm

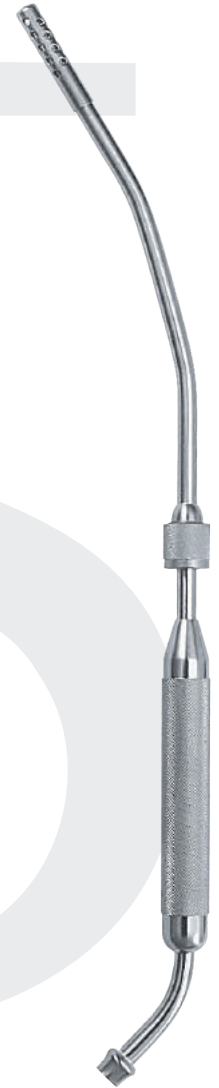

Cooley
33,0 cm **00-923-08**

Scheren
Scissors

01





gerade
straight

Standard,
Fig. 1

11,5 cm **01-000-11**
13,5 cm **01-000-13**
14,5 cm **01-000-14**
15,5 cm **01-000-15**
16,5 cm **01-000-16**
18,5 cm **01-000-18**
20,5 cm **01-000-20**



gebogen
curved

Standard,
Fig. 1

01-001-11
01-001-13
01-001-14
01-001-15
01-001-16
01-001-18
01-001-20



gerade
straight

Standard,
Fig. 2

01-002-11
01-002-13
01-002-14
01-002-15
01-002-16
01-002-18
01-002-20



gebogen
curved

Standard,
Fig. 2

11,5 cm **01-003-11**
13,5 cm **01-003-13**
14,5 cm **01-003-14**
15,5 cm **01-003-15**
16,5 cm **01-003-16**
18,5 cm **01-003-18**
20,5 cm **01-003-20**



gerade
straight

Standard,
Fig. 3

01-004-11
01-004-13
01-004-14
01-004-15
01-004-16
01-004-18
01-004-20



gebogen
curved

Standard,
Fig. 3

01-005-11
01-005-13
01-005-14
01-005-15
01-005-16
01-005-18
01-005-20

Instrumente auch erhältlich mit TC-Hartmetalleinsatz, SC-Supercuttschliff, Titan-Nitrit-Beschichtung und für Linkshänder (L)

Intruments also available with TC-Carbid inlay, SC-supercut Edge, Titan-Nitrite-Coating and for left-handers (L)

SC-Supercuttschliff
Supercut Edge 

TC-Hartmetalleinsatz
Carbid inlay 



gerade
straight

Chir. Schere, grazil
Fig. 1
13,0 cm **01-010-13**
14,5 cm **01-010-14**



gebogen
curved

Chir. Schere, grazil
Fig. 1
01-011-13
01-011-14



gerade
straight

Chir. Schere, grazil
Fig. 2
01-012-13
01-012-14



gebogen
curved

Chir. Schere, grazil
Fig. 2
13,0 cm **01-013-13**
14,5 cm **01-013-14**



gerade
straight

Chir. Schere, grazil
Fig. 3
01-014-13
01-014-14



gebogen
curved

Chir. Schere, grazil
Fig. 3
01-015-13
01-015-14



gerade, 1 Blatt gezahnt
straight, 1 blade serrated

Wundrandschere
Scissors for wound edges
13,0 cm **01-020-13**



gebogen, 1 Blatt gezahnt
curved, 1 blade serrated

Wundrandschere
Scissors for wound edges
13,0 cm **01-021-13**



gerade
straight

Chir. Schere
13,0 cm **01-100-13**
14,5 cm **01-100-14**



gerade
straight

Chir. Schere
16,5 cm **01-102-16**



gerade
straight

Deaver
14,0 cm **01-104-14**



gebogen
curved

Deaver
14,0 cm **01-105-14**

Instrumente auch erhältlich mit TC-Hartmetalleinsatz, SC-Supercuttschliff, Titan-Nitrit-Beschichtung und für Linkshänder (L)

Instruments also available with TC-Carbid inlay, SC-supercut Edge, Titan-Nitrite-Coating and for left-handers (L)

SC-Supercuttschliff
Supercut Edge 

TC-Hartmetalleinsatz
Carbid inlay 



gerade
straight

Mixer
15,0 cm 01-106-15



gebogen
curved

Mixer
15,0 cm 01-107-15



abgewinkelt
angled

Richter
14,0 cm 01-109-14



abgewinkelt
angled

Fergusson
18,0 cm 01-111-18



gerade
straight

Doyen
16,5 cm 01-114-16



gebogen
curved

Doyen
16,5 cm 01-115-16



gerade
straight

Sims
Fig. 1

20,0 cm **01-120-20**
23,0 cm **01-120-23**



gebogen
curved

Sims
Fig. 1

20,0 cm **01-121-20**
23,0 cm **01-121-23**



gerade
straight

Sims
Fig. 2

20,0 cm **01-122-20**
23,0 cm **01-122-23**



gebogen
curved

Sims
Fig. 2

01-123-20
01-123-23



gerade
straight

Sims
Fig. 3

01-124-20
01-124-23



gebogen
curved

Sims
Fig. 3

01-125-20
01-125-23

Instrumente auch erhältlich mit TC-Hartmetalleinsatz, SC-Supercuttschliff, Titan-Nitrit-Beschichtung und für Linkshänder (L)

Instruments also available with TC-Carbid inlay, SC-supercut Edge, Titan-Nitrite-Coating and for left-handers (L)

SC-Supercuttschliff
Supercut Edge 

TC-Hartmetalleinsatz
Carbid inlay 



gerade
straight

Sims-Siebold
25,0 cm **01-126-25**



S-förmig
s-shaped

Sims-Siebold
24,0 cm **01-127-24**

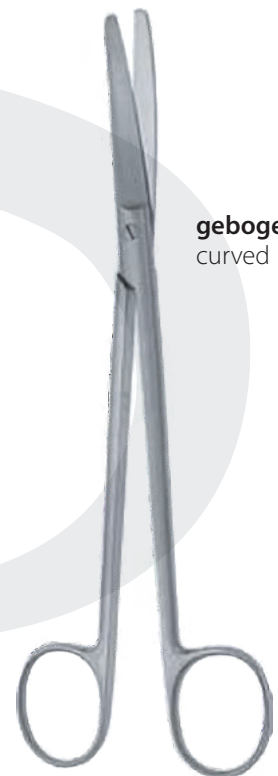

gebogen
curved

Wertheim
14,0 cm **01-131-14**
20,0 cm **01-131-20**
23,0 cm **01-131-22**



gerade
straight

Dubois
27,0 cm **01-132-27**



gebogen
curved

Dubois
27,0 cm **01-133-27**



gebogen
curved

Crafoord
30,0 cm **01-137-30**



Braun-Stadler
14,0 cm **01-139-14**
22,0 cm **01-139-22**



Waldmann
18,0 cm **01-141-18**

Instrumente auch erhältlich mit TC-Hartmetalleinsatz, SC-Supercuttschliff, Titan-Nitrit-Beschichtung und für Linkshänder (L)

Instruments also available with TC-Carbid inlay, SC-supercut Edge, Titan-Nitrite-Coating and for left-handers (L)

SC-Supercuttschliff
Supercut Edge 

TC-Hartmetalleinsatz
Carbid inlay 



Modell USA
10,5 cm **01-144-10**



Schuhmacher
15,5 cm **01-145-16**



Busch
13,0 cm **01-147-13**
16,0 cm **01-147-16**



Darmschere
Bowel Scissors
21,0 cm **01-150-21**



Darmschere
Bowel Scissors
15,0 cm **01-151-15**
21,0 cm **01-151-21**



gerade
straight

Mayo

14,0 cm **01-160-14**
15,0 cm **01-160-15**
17,0 cm **01-160-17**
23,0 cm **01-160-23**



gebogen
curved

Mayo

14,0 cm **01-161-14**
15,0 cm **01-161-15**
17,0 cm **01-161-17**
23,0 cm **01-161-23**



gerade
straight

Mayo-Harrington

22,5 cm **01-166-22**



gebogen
curved

Mayo-Harrington

22,0 cm **01-167-22**



gebogen
curved

Jorgensen

23,0 cm **01-169-23**

Instrumente auch erhältlich mit TC-Hartmetalleinsatz, SC-Supercuttschliff, Titan-Nitrit-Beschichtung und für Linkshänder (L)

Instruments also available with TC-Carbid inlay, SC-supercut Edge, Titan-Nitrite-Coating and for left-handers (L)

SC-Supercuttschliff
Supercut Edge 

TC-Hartmetalleinsatz
Carbid inlay 



gerade
straight

Mayo-Style

- 15,0 cm **01-170-15**
- 17,0 cm **01-170-17**
- 19,0 cm **01-170-19**
- 21,0 cm **01-170-21**



gebogen
curved

Mayo-Style

- 15,0 cm **01-171-15**
- 17,0 cm **01-171-17**
- 19,0 cm **01-171-19**
- 21,0 cm **01-171-21**

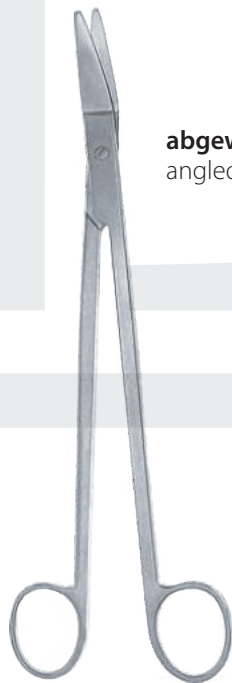

abgewinkelt
angled

Resano Kapselschere
24,5 cm **01-175-24**



gerade
straight

Mayo-Noble
17,0 cm **01-176-17**



gebogen
curved

Mayo-Noble
17,0 cm **01-177-17**



geradet
straight

Metzenbaum

Fig.1

14,5 cm **01-200-14**
18,0 cm **01-200-18**
20,0 cm **01-200-20**



gebogen
curved

Metzenbaum

Fig.1

14,5 cm **01-201-14**
01-201-18
01-201-20



gerade
straight

Metzenbaum

Fig.2

14,0 cm **01-202-14**
18,0 cm **01-202-18**
20,0 cm **01-202-20**



geradet
straight

Metzenbaum

Fig.2

14,0 cm **01-203-14**
18,0 cm **01-203-18**
20,0 cm **01-203-20**



geradet
straight

Metzenbaum

Fig.3

14,0 cm **01-204-14**
18,0 cm **01-204-18**
20,0 cm **01-204-20**



geradet
straight

Metzenbaum

Fig.3

14,0 cm **01-205-14**
18,0 cm **01-205-18**
20,0 cm **01-205-20**

Instrumente auch erhältlich mit TC-Hartmetalleinsatz, SC-Supercuttschliff, Titan-Nitrit-Beschichtung und für Linkshänder (L)

Intruments also available with TC-Carbid inlay, SC-supercut Edge, Titan-Nitrite-Coating and for left-handers (L)

SC-Supercuttschliff
Supercut Edge 

TC-Hartmetalleinsatz
Carbid inlay 



gerade
straight

SC Available

Metzenbaum-Fino
Fig.1

- 14,0 cm **01-210-14**
- 18,0 cm **01-210-18**
- 20,0 cm **01-210-20**



gebogen
curved

SC Available

Metzenbaum-Fino
Fig.1

- 14,0 cm **01-211-14**
- 18,0 cm **01-211-18**
- 20,0 cm **01-211-20**



gerade
straight

Metzenbaum-Fino
Fig.3

- 14,5 cm **01-214-14**
- 18,0 cm **01-214-18**
- 20,0 cm **01-214-20**



gebogen
curved

Metzenbaum-Fino
Fig.3

- 14,5 cm **01-215-14**
- 18,0 cm **01-215-18**
- 20,0 cm **01-215-20**



S-förmig
S-shaped

Metzenbaum-Fino
Fig.1

- 14,0 cm **01-221-14**
- 18,0 cm **01-221-18**
- 20,0 cm **01-221-20**



gerade
straight

Metzenbaum
Fig.1

- 15,0 cm **01-226-15**



gebogen
curved

Metzenbaum
Fig.1

- 15,0 cm **01-227-15**



gerade
straight

Metzenbaum-Baby
11,5 cm **01-228-11**



gebogen
curved

Metzenbaum-Baby
11,5 cm **01-229-11**



gerade
straight

Mayo-Lexer
16,5 cm **01-230-16**



gebogen
curved

Mayo-Lexer
16,5 cm **01-231-16**



gerade
straight

Lexer-Fino
16,5 cm **01-232-16**



gebogen
curved

Lexer-Fino
16,5 cm **01-233-16**



gerade
straight

Lexer-Baby
10,5 cm **01-234-10**



gebogen
curved

Lexer-Baby
10,5 cm **01-235-10**

Instrumente auch erhältlich mit TC-Hartmetalleinsatz, SC-Supercuttschliff, Titan-Nitrit-Beschichtung und für Linkshänder (L)

Intruments also available with TC-Carbid inlay, SC-supercut Edge, Titan-Nitrite-Coating and for left-handers (L)

SC-Supercuttschliff
Supercut Edge 

TC-Hartmetalleinsatz
Carbid inlay 



gerade
straight

Strabismus
11,0 cm **01-236-11**



gebogen
curved

Strabismus
11,0 cm **01-237-11**

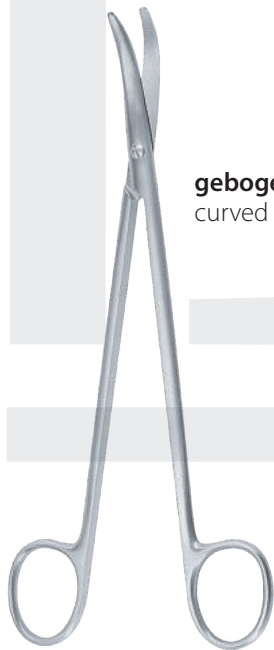

gebogen
curved

Thorek
19,0 cm **01-241-19**



gerade, gezahnt
straight, serrated

Gorney
12,5 cm **01-242-12**
19,5 cm **01-242-19**



gebogen, gezahnt
curved, serrated

Gorney
19,5 cm **01-243-19**



gebogen
curved

Kilner (Ragnell)
12,0 cm **01-245-12**
15,0 cm **01-245-15**
18,0 cm **01-245-18**



gerade
straight

Reynolds
15,0 cm **01-248-15**
18,0 cm **01-248-18**



gebogen
curved

Reynolds

15,0 cm **01-249-15**
18,0 cm **01-249-18**



gerade
straight

Tönnis
18,0 cm **01-250-18**



gebogen
curved

Tönnis

18,0 cm **01-251-18**



gebogen
curved

Tönnis-Adson
17,5 cm **01-253-17**



gerade, gezahnt
straight, serrated

Beuse
14,5 cm **01-258-14**



gebogen, gezahnt
curved, serrated

Beuse
14,5 cm **01-259-14**

Instrumente auch erhältlich mit TC-Hartmetalleinsatz, SC-Supercuttschliff, Titan-Nitrit-Beschichtung und für Linkshänder (L)

Instruments also available with TC-Carbid inlay, SC-supercut Edge, Titan-Nitrite-Coating and for left-handers (L)

SC-Supercuttschliff
Supercut Edge 

TC-Hartmetalleinsatz
Carbid inlay 

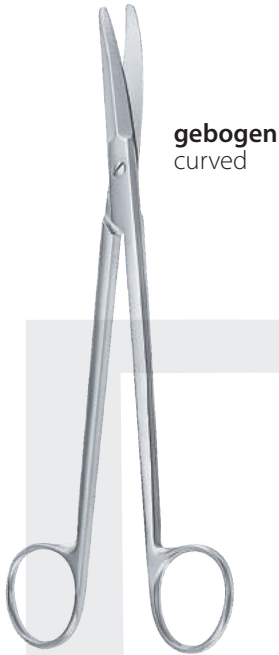

gebogen
curved

Böttcher
18,5 cm **01-301-18**



Dean
17,0 cm **01-305-17**



gezahnt
serrated

Dean
17,0 cm **01-307-17**



gebogen
curved

Good
19,0 cm **01-309-19**



gebogen,gezahnt
curved, serrated

Good-Schwekendieck
19,0 cm **01-311-19**



McIndoe
12,0 cm **01-312-12**
16,0 cm **01-212-16**
19,0 cm **01-212-19**



abgewinkelt
angled

Fomon
13,0 cm **01-327-13**



abgewinkelt
angled

Cottle
16,0 cm **01-331-16**



Heymann
17,0 cm **01-333-17**
18,0 cm **01-333-18**
20,0 cm **01-333-20**



stark gebogen
strong curved

Fomon
11,5 cm **01-343-11**
13,5 cm **01-343-13**



gebogen
curved

Fomon
13,5 cm **01-343-13**



stark gebogen
strong curved

Landolt
11,5 cm **01-345-11**



gebogen
curved

Landolt
11,5 cm **01-345-12**

Instrumente auch erhältlich mit TC-Hartmetalleinsatz, SC-Supercuttschliff, Titan-Nitrit-Beschichtung und für Linkshänder (L)

Intruments also available with TC-Carbid inlay, SC-supercut Edge, Titan-Nitrite-Coating and for left-handers (L)

SC-Supercuttschliff
Supercut Edge 

TC-Hartmetalleinsatz
Carbid inlay 

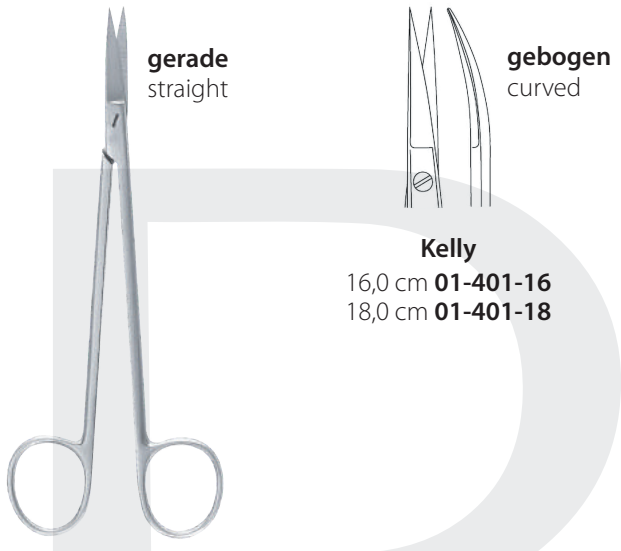

Kelly
16,0 cm **01-401-16**
18,0 cm **01-401-18**

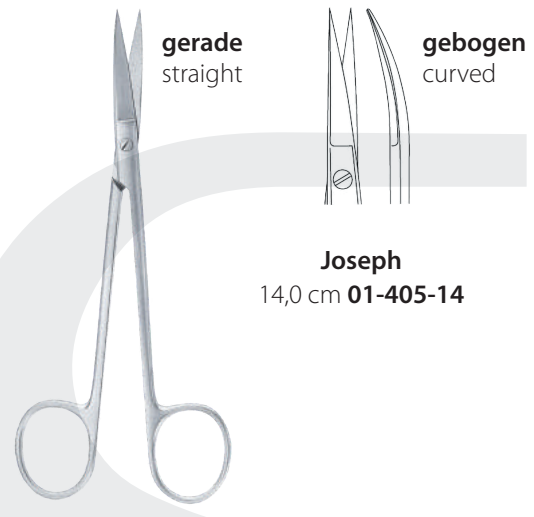

Joseph
14,0 cm **01-405-14**

Kelly
16,0 cm **01-400-16**
18,0 cm **01-400-18**

Joseph
14,0 cm **01-404-14**

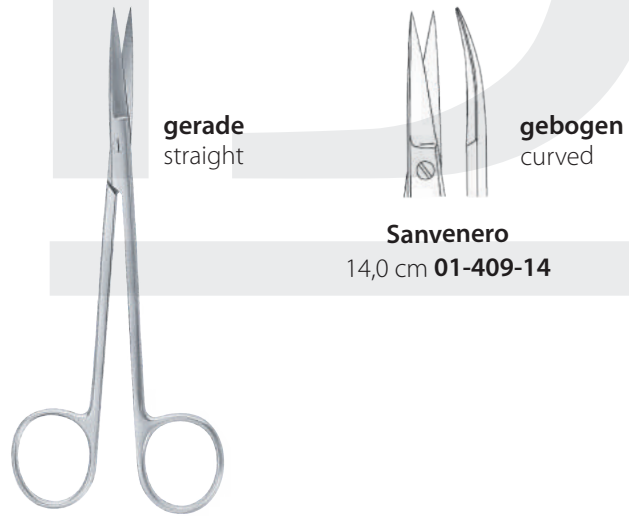

Sanvenero
14,0 cm **01-409-14**

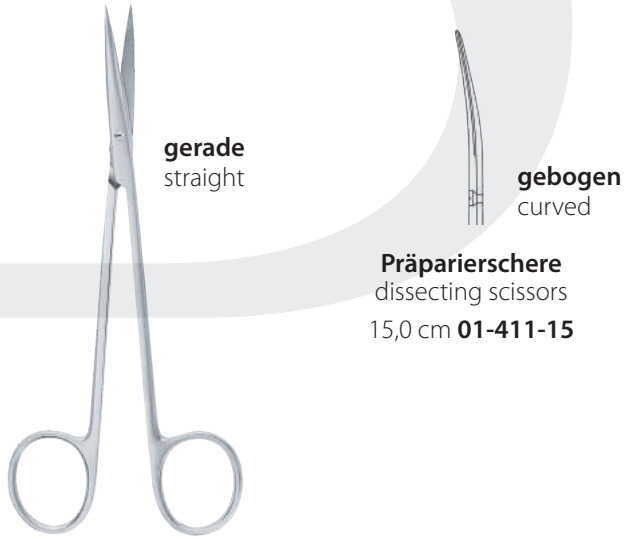

Präparierschere
dissecting scissors
15,0 cm **01-411-15**

Sanvenero
14,0 cm **01-408-14**

Präparierschere
dissecting scissors
15,0 cm **01-410-15**

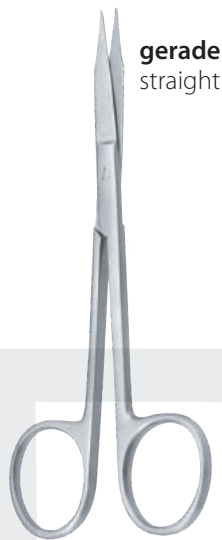

gerade
straight



gebogen
curved

Goldman-Fox
13,0 cm **01-417-13**

1 Schneide gezahnt
1 blade serrated

Goldman-Fox
13,0 cm **01-416-13**



gerade
straight



gebogen
curved

Feine Schere
11,0 cm **01-418-11**

Feine Schere
11,0 cm **01-419-11**



gerade
straight

Wagner
Fig. 1
12,0 cm **01-420-12**



gebogen
curved

Fig. 1
12,0 cm **01-421-12**



gerade
straight

Fig. 2
12,0 cm **01-422-12**



gebogen
curved

Fig. 2
12,0 cm **01-423-12**



gerade
straight

Fig. 3
12,0 cm **01-424-12**



gebogen
curved

Fig. 3
12,0 cm **01-425-12**

Instrumente auch erhältlich mit TC-Hartmetalleinsatz, SC-Supercuttschliff, Titan-Nitrit-Beschichtung und für Linkshänder (L)

Instruments also available with TC-Carbid inlay, SC-supercut Edge, Titan-Nitrite-Coating and for left-handers (L)

SC-Supercuttschliff
Supercut Edge 

TC-Hartmetalleinsatz
Carbid inlay 



gerade
straight

Strabismus-Schere
Strabismus-Scissors
11,5 cm **01-428-11**



gebogen
curved

Strabismus-Schere
Strabismus-Scissors
01-429-11



gebogen
curved

Littler
11,0 cm **01-431-11**
14,0 cm **01-431-14**



gerade
straight

Stevens
Fig. 1
10,5 cm **01-432-10**
11,5 cm **01-432-11**



gebogen
curved

Fig. 1
10,5 cm **01-433-10**
11,5 cm **01-433-11**



gerade
straight

Stevens
Fig. 3
10,5 cm **01-434-10**
11,5 cm **01-434-11**



gebogen
curved

Fig. 3
10,5 cm **01-435-10**
11,5 cm **01-435-11**



gerade
straight

Iris

9,0 cm **01-440-09**
10,5 cm **01-440-10**
11,5 cm **01-440-11**
12,0 cm **01-440-12**



gebogen
curved

Iris

9,0 cm **01-441-09**
10,0 cm **01-441-10**
11,0 cm **01-441-11**
12,0 cm **01-441-12**



gerade
straight

Iris Fino

10,0 cm **01-442-10**
11,5 cm **01-442-11**



gebogen
curved

Iris Fino

10,0 cm **01-443-10**
11,5 cm **01-443-11**



gerade
straight

Bonn

8,0 cm **01-446-08**
9,0 cm **01-446-09**



gebogen
curved

Bonn

8,0 cm **01-447-08**
9,0 cm **01-447-09**

sehr fein
extra delicate



abgewinkelt
angled

Graefe

10,0 cm **01-449-10**



gebogen
curved

La Grange

11,0 cm **01-453-11**

Instrumente auch erhältlich mit TC-Hartmetalleinsatz, SC-Supercuttschliff, Titan-Nitrit-Beschichtung und für Linkshänder (L)

Instruments also available with TC-Carbid inlay, SC-supercut Edge, Titan-Nitrite-Coating and for left-handers (L)

SC-Supercuttschliff
Supercut Edge 

TC-Hartmetalleinsatz
Carbid inlay 



Satinsky
24,0 cm **01-501-24**



Klinkenbergh-Loth
23,0 cm **01-503-23**

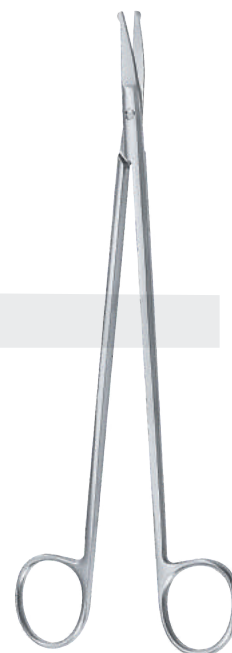

Strully
22,0 cm **01-505-22**



Church
17,0 cm **01-506-17**



Church
17,0 cm **01-507-17**

gerade
straight

gebogen
curved



Dandy
17,0 cm **01-511-17**

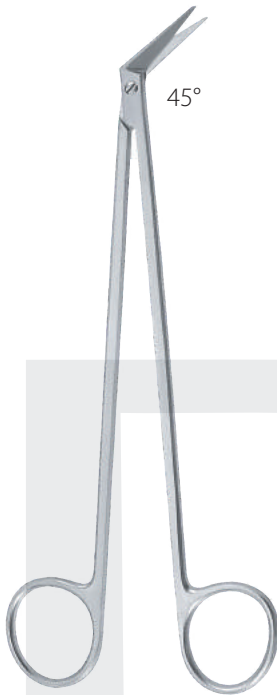

45°

Potts-Smith
19,0 cm **01-515-19**



Mills
19,0 cm **01-517-19**

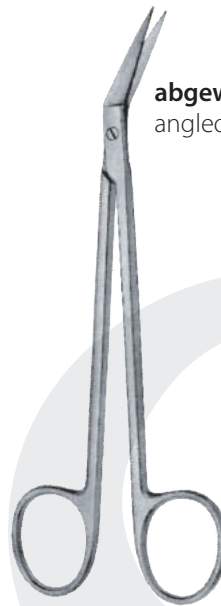

abgewinkelt, gezahnt
angled, serrated

Locklin
16,0 cm **01-519-16**



s-förmig
s-shaped

Locklin
16,0 cm **01-521-16**



Schmieden-Taylor
17,0 cm **01-523-17**



Favaloro
15,5 cm **01-529-15**



Coronar mit Knopf
with probe point
12,0 cm **01-530-11**



Schere
Scissor
11,5 cm **01-531-11**

Instrumente auch erhältlich mit TC-Hartmetalleinsatz, SC-Supercuttschliff, Titan-Nitrit-Beschichtung und für Linkshänder (L)

Intruments also available with TC-Carbid inlay, SC-supercut Edge, Titan-Nitrite-Coating and for left-handers (L)

SC-Supercuttschliff
Supercut Edge 

TC-Hartmetalleinsatz
Carbid inlay 

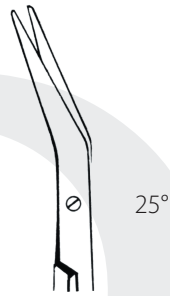
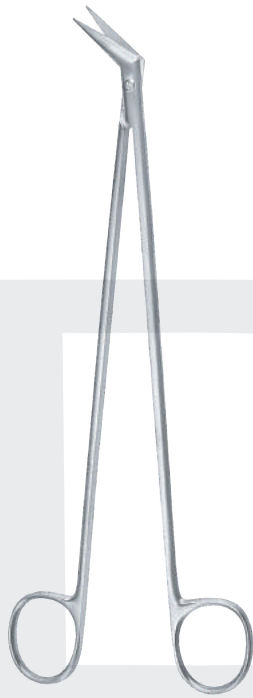

16,0 cm **01-541-16**
23,0 cm **01-541-23**

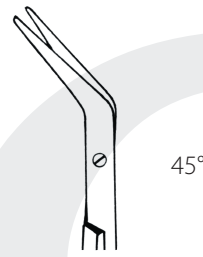

16,0 cm **01-543-16**
23,0 cm **01-543-23**

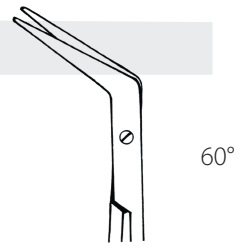

16,0 cm **01-545-16**
23,0 cm **01-545-23**

De Bakey

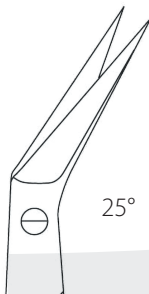

19,0 cm **01-551-19**

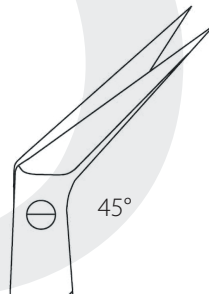

19,0 cm **01-553-19**

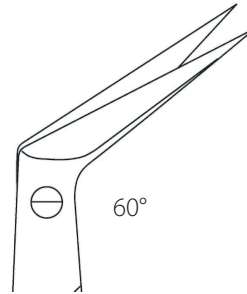

19,0 cm **01-555-19**

mit Knopf
with probe point

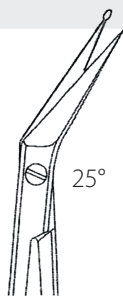

19,0 cm **01-561-19**

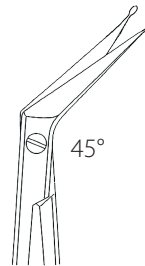

19,0 cm **01-563-19**

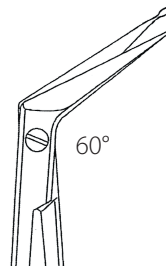

19,0 cm **01-565-19**

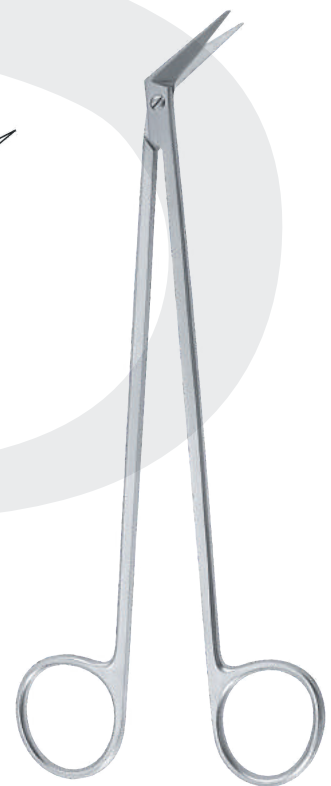

Potts-Smith

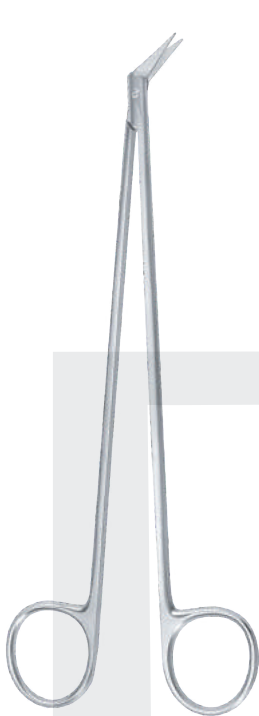

Dietrich

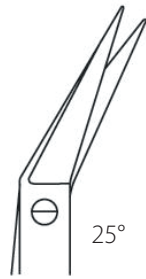

13,0 cm **01-571-13**
19,0 cm **01-571-19**

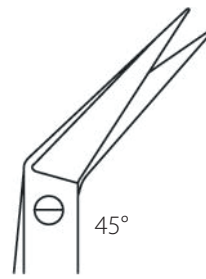

13,0 cm **01-573-13**
19,0 cm **01-573-19**

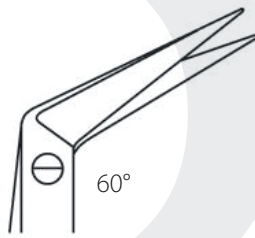

13,0 cm **01-575-13**
19,0 cm **01-575-19**

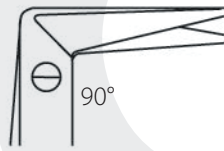

13,0 cm **01-577-13**
19,0 cm **01-577-19**

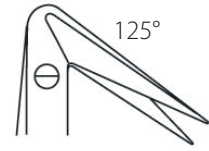

19,0 cm **01-579-19**



Hagemann-Dietrich

19,0 cm **01-589-19**



Instrumente auch erhältlich mit TC-Hartmetalleinsatz, SC-Supercuttschliff, Titan-Nitrit-Beschichtung und für Linkshänder (L)

Intruments also available with TC-Carbid inlay, SC-supercut Edge, Titan-Nitrite-Coating and for left-handers (L)

SC-Supercuttschliff
Supercut Edge 

TC-Hartmetalleinsatz
Carbid inlay 

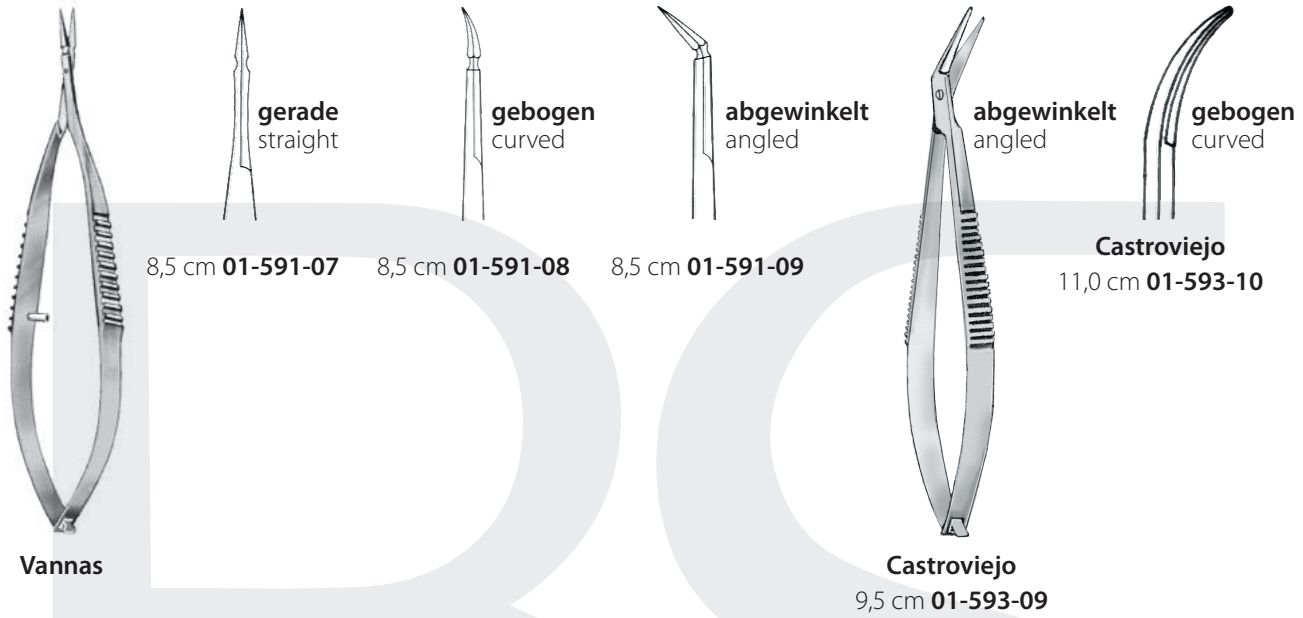

Vannas
8,5 cm **01-591-07** (gerade straight)
8,5 cm **01-591-08** (gebogen curved)
8,5 cm **01-591-09** (abgewinkelt angled)

Castroviejo
11,0 cm **01-593-10** (abgewinkelt angled, gebogen curved)
9,5 cm **01-593-09** (abgewinkelt angled)

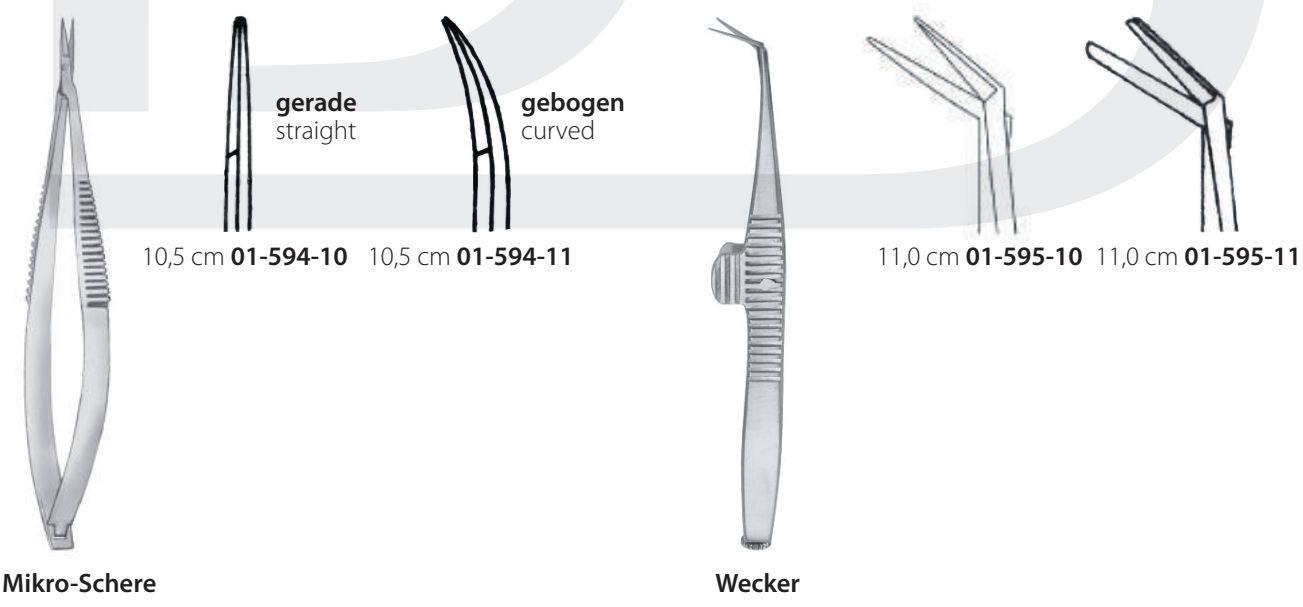

Mikro-Schere
10,5 cm **01-594-10** (gerade straight)
10,5 cm **01-594-11** (gebogen curved)

Wecker
11,0 cm **01-595-10** (abgewinkelt angled)
11,0 cm **01-595-11** (abgewinkelt angled)



Mikro-Schere
15,0 cm **01-601-15**

01-600-15



gerade
straight



gebogen
curved

01-601-15

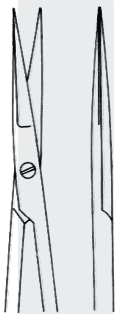

01-602-19

gerade
straight



01-603-19

aufgebogen
curved



01-604-19

abgebogen
curved downward

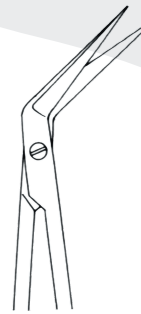

01-605-19

abgewinkelt
angled



Mikro-Schere
19,0 cm

Instrumente auch erhältlich mit TC-Hartmetalleinsatz, SC-Supercuttschliff, Titan-Nitrit-Beschichtung und für Linkshänder (L)

Instruments also available with TC-Carbid inlay, SC-supercut Edge, Titan-Nitrite-Coating and for left-handers (L)

SC-Supercuttschliff
Supercut Edge 

TC-Hartmetalleinsatz
Carbid inlay 

Mikro-Scheren, bajonettförmig
 Micro Scissors, bayonet-shaped



Mikro-Schere



gerade
straight

21,0 cm **01-606-21**



gebogen
curved

01-607-21



gerade
straight

15,0 cm **01-608-15**



gebogen
curved

01-609-15



Mikro-Schere



gerade
straight

19,0 cm **01-610-19**
 21,0 cm **01-612-21**



gebogen
curved

01-611-19
01-613-21



Jakobsen - Mikro Schere

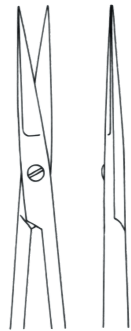

gerade
straight

18,5 cm **01-614-18**



gebogen
curved

18,5 cm **01-615-18**



abgewinkelt
angled

18,5 cm **01-616-18**



25°

18,0 cm **01-617-18**

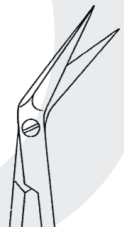

45°

18,0 cm **01-618-18**

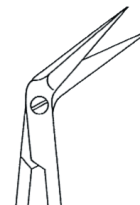

60°

18,0 cm **01-619-18**



90°

18,0 cm **01-620-18**

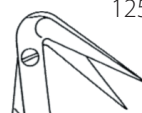

125°

18,0 cm **01-621-18**

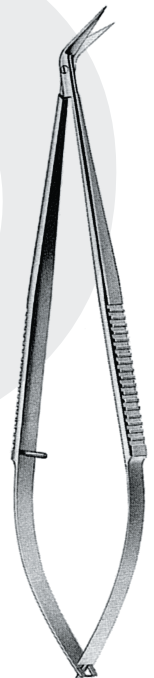

Mikro-Schere

Instrumente auch erhältlich mit TC-Hartmetalleinsatz, SC-Supercuttschliff, Titan-Nitrit-Beschichtung und für Linkshänder (L)

Intruments also available with TC-Carbid inlay, SC-supercut Edge, Titan-Nitrite-Coating and for left-handers (L)

SC-Supercuttschliff
Supercut Edge 

TC-Hartmetalleinsatz
Carbid inlay 



Mikro-Schere
mit Knopf
with probe point



18,0 cm **01-622-18**



18,0 cm **01-623-18**

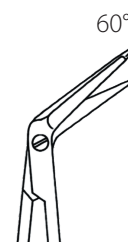

18,0 cm **01-624-18**



18,0 cm **01-625-18**



18,0 cm **01-626-18**



Reill



15,5 cm **01-627-15**

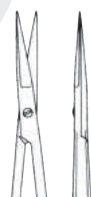

14,0 cm **01-628-14**



15,5 cm **01-629-15**

1 Blatt gezahnt
1 blade serrated



Reill



11,5 cm **01-630-11**

Westcott



01-631-11

Noyes-Federschere
Noyes-spring type



12,0 cm **01-632-12**



Reill
9,0 cm **01-634-09**



Reill
9,0 cm **01-635-09**



Instrumente auch erhältlich mit TC-Hartmetalleinsatz, SC-Supercuttschliff, Titan-Nitrit-Beschichtung und für Linkshänder (L)

Intruments also available with TC-Carbid inlay, SC-supercut Edge, Titan-Nitrite-Coating and for left-handers (L)

SC-Supercuttschliff
Supercut Edge 

TC-Hartmetalleinsatz
Carbid inlay 

Mikro-Scheren, bajonettförmig
 Micro Scissors, bayonet-shaped

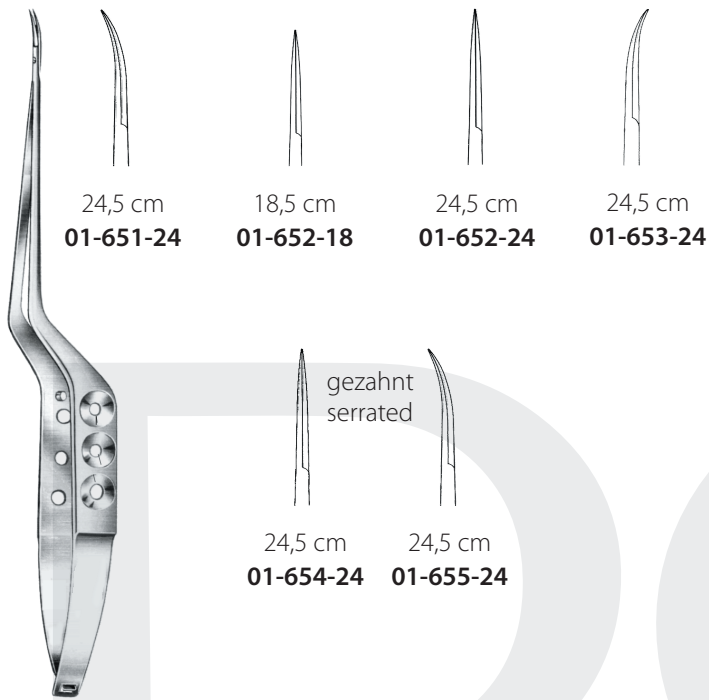

24,5 cm
01-651-24

18,5 cm
01-652-18

24,5 cm
01-652-24

24,5 cm
01-653-24

gezahnt
 serrated
 24,5 cm **01-654-24** 24,5 cm **01-655-24**

Yasargil



22,5 cm **01-656-22**

22,5 cm **01-657-22**

Vannas



Mikro-Schere

23,0 cm **01-684-23**



Mikro-Schere

14,5 cm **01-810-14**
 18,0 cm **01-810-18**

01-811-14
01-811-18

01-843-14
01-843-18

Präparierschere
 Dissecting Scissors



Spencer

9,0 cm **01-700-09**
10,0 cm **01-700-10**
12,0 cm **01-700-12**



Spencer

11,0 cm **01-701-11**



Northbent

9,0 cm **01-705-09**
12,5 cm **01-705-13**



Littauer

12,5 cm **01-706-13**
14,0 cm **01-706-14**
16,0 cm **01-706-16**



Buck

14,5 cm **01-708-14**
18,0 cm **01-708-18**



Eiselberg

12,0 cm **01-710-12**

Instrumente auch erhältlich mit TC-Hartmetalleinsatz, SC-Supercuttschliff, Titan-Nitrit-Beschichtung und für Linkshänder (L)

Intruments also available with TC-Carbid inlay, SC-supercut Edge, Titan-Nitrite-Coating and for left-handers (L)

SC-Supercuttschliff
Supercut Edge 

TC-Hartmetalleinsatz
Carbid inlay 

gezahnt
serrated



Beebe

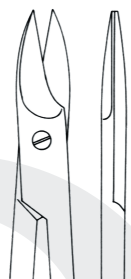

10,5 cm **01-714-10**
12,0 cm **01-714-12**



10,5 cm **01-715-10**
12,0 cm **01-715-12**



12,0 cm **01-719-12**



Universal
12,0 cm **01-721-12**



Harvey
12,0 cm **01-722-12**



Schuhknecht
10,0 cm **01-724-10**

TC-Scheren
TC-Scissors

02



Scheren mit Hartmetallschneiden

auch unter der Bezeichnung WOLFRAM oder TUNGSTEN CARBIDE (TC) ein weltweiter Begriff. Eine der härtesten Metall-Legierungen, die annähernd Diamant-Härte erreicht.

TC-Scheren sind "das Werkzeug" des Chirurgen und müssen deshalb von dauerhafter, gleichbleibender Qualität sein.

Scissors with TC Cutting Edges

also known as WOLFRAM or TUNGSTEN CARBIDE cutting edges, is a term that is recognized world-wide. This is one of the hardest metal alloy compositions and it approaches "diamond hardness".

TC-Scissors are the surgeon's tool and, therefore, must be durable with lasting quality.

Berger Surgical TC-Scheren zeichnen sich besonders aus durch:

- exzellente Schnitthaltigkeit
- lange Lebensdauer
- 5 Jahre Garantie
- geschweißte Hartmetall-Einlagen
- vergoldete Ringe
- weicher, gleichmäßiger Gang

Berger Surgical TC-Scissors are particularly distinguished due to their:

- excellent cutting properties
- durability
- 5 years guarantee
- welded Tungsten Carbide Inserts
- goldplated rings
- smoother and consistent pressure function



Wellenschliff

Alle TC-Scheren sind auch mit "BS-Wellenschliff" erhältlich. Die Scheren sind auf der unteren Schnittfläche mit diesem "BS-Wellenschliff" versehen. Dadurch wird das Herausgleiten von Gewebe verhindert.

Wave Cuttig Edges

All scissors are available with wavy cutting edges ("BS-Wellenschliff"). The scissors have a special grind on the lower cutting edges. This prevents tissue from slipping out.

stumpf/stumpf
blunt/blunt

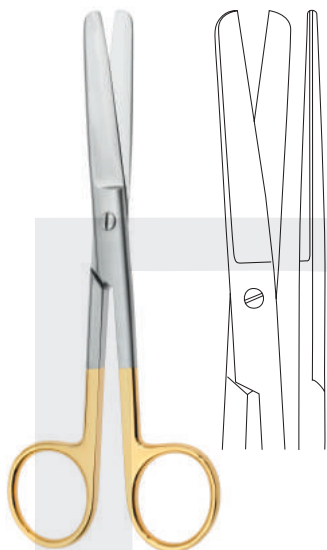

Standard, Fig. 1
14,5 cm 02-000-14

spitz/stumpf
sharp/blunt



Standard, Fig. 2
02-002-14

spitz/spitz
sharp/sharp

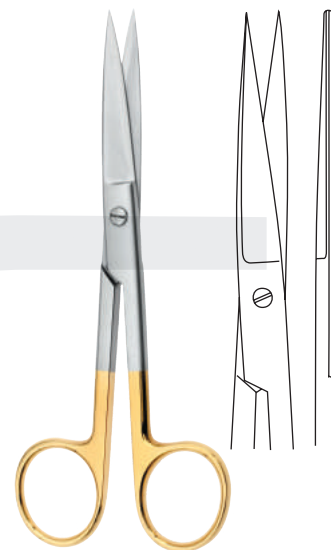

Standard, Fig. 3
02-004-14

stumpf/stumpf
blunt/blunt

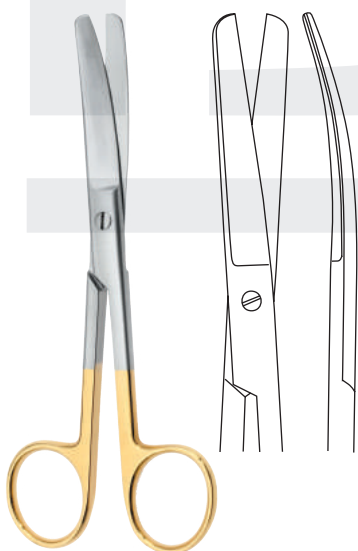

Standard, Fig. 1
14,5 cm 02-001-14

spitz/stumpf
sharp/blunt

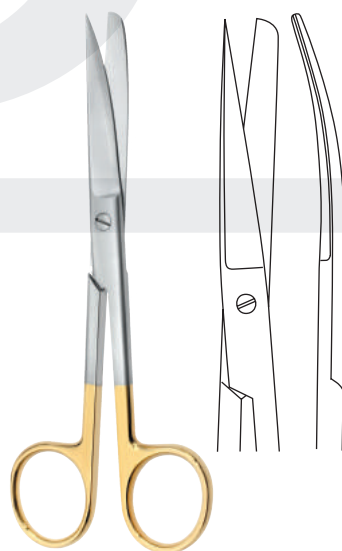

Standard, Fig. 2
02-003-14

spitz/spitz
sharp/sharp

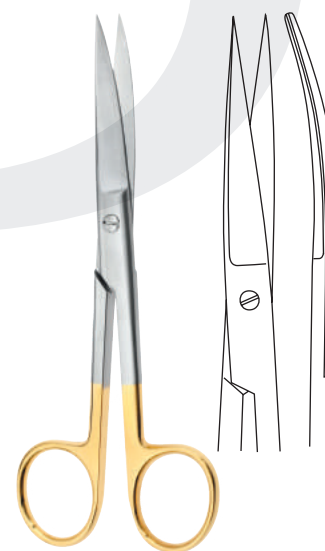

Standard, Fig. 3
02-005-14

stumpf/stumpf
blunt/blunt

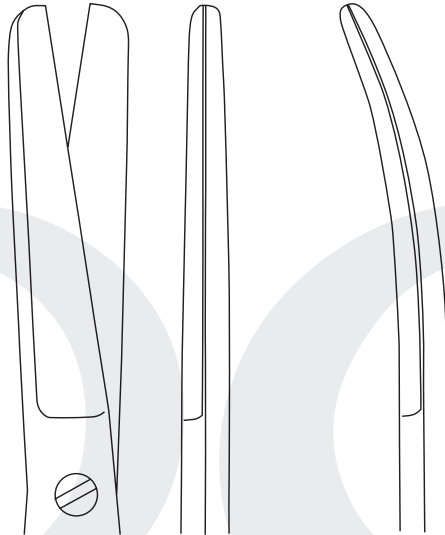

Fig. 1
20,0 cm **02-120-20**
23,0 cm **02-120-23**

02-121-20
02-121-23



Sims

spitz/stumpf
sharp/blunt



Fig. 2
20,0 cm **02-122-20**
23,0 cm **02-122-23**

02-123-20
02-123-23

spitz/spitz
sharp/sharp

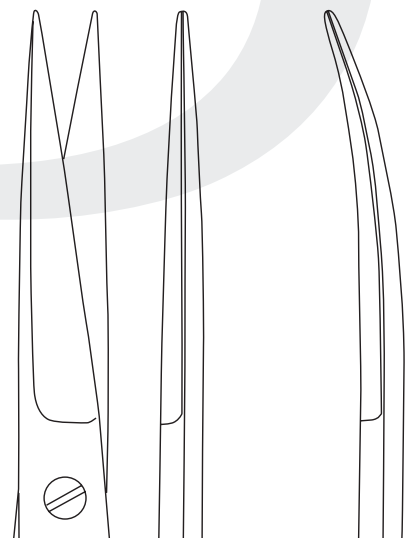
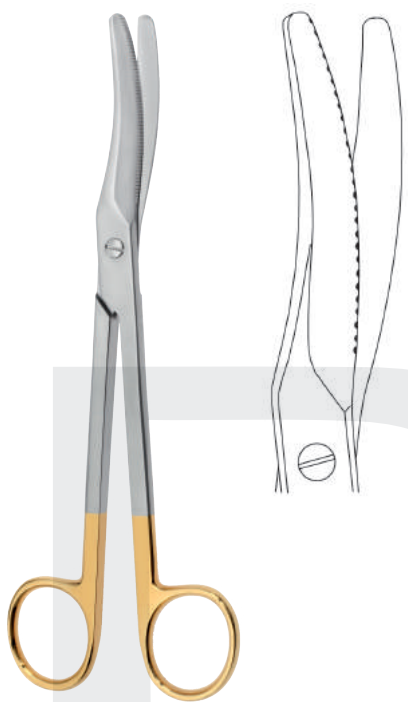

Fig. 3
02-124-20
02-124-23

02-125-20
02-125-23



Waldmann

20,0 cm **02-141-20**



Mayo

14,0 cm **02-160-14**
17,0 cm **02-160-17**
23,0 cm **02-160-23**

02-161-14
02-161-17
02-161-23



Mayo-Harrington

22,0 cm **02-166-22**

02-167-22



Parametrium

23,0 cm **02-169-23**



Mayo-Style



15,0 cm **02-170-15**
17,0 cm **02-170-17**
21,0 cm **02-170-21**



02-171-15
02-171-17
02-171-21

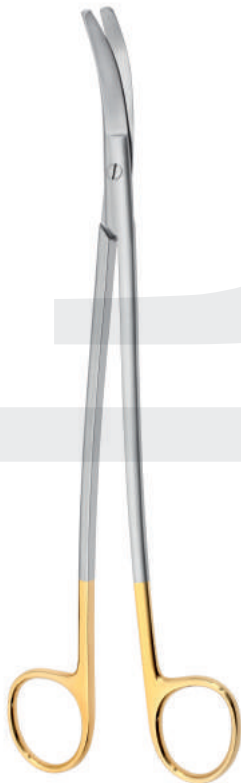

Hysterektomie



25,5 cm **02-173-25**



02-175-25

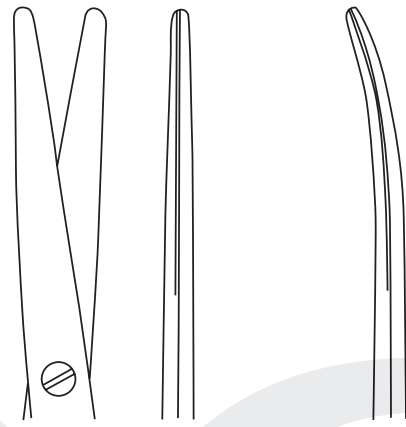
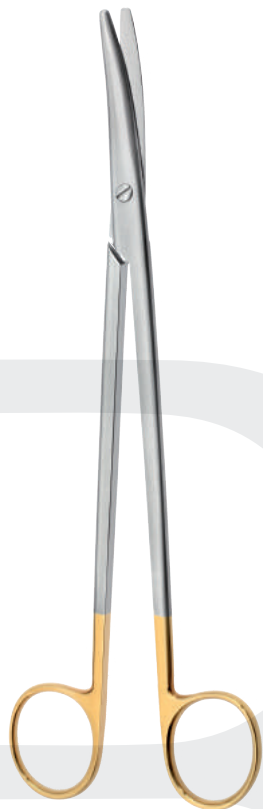

11,0 cm **02-200-11**
14,0 cm **02-200-14**
18,0 cm **02-200-18**
20,0 cm **02-200-20**

02-201-11
02-201-14
02-201-18
02-201-20

Metzenbaum, Fig. 1

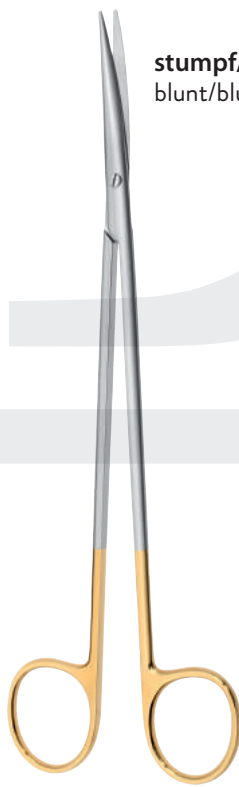

stumpf/stumpf
blunt/blunt

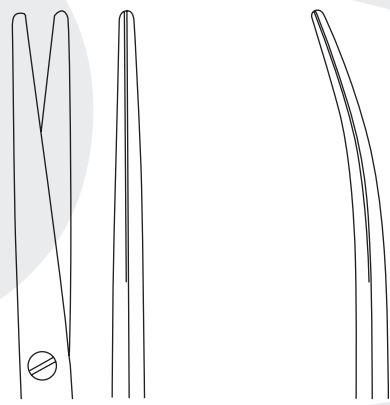

14,0 cm **02-210-14**
18,0 cm **02-210-18**
20,0 cm **02-210-20**

02-211-14
02-211-18
02-211-20

Metzenbaum-Fino, Fig. 1

spitz/spitz
sharp/sharp



Metzenbaum-Fino, Fig. 3

14,0 cm	02-214-14	02-215-14
18,0 cm	02-214-18	02-215-18
20,0 cm	02-214-20	02-215-20
23,0 cm	02-214-23	02-215-23

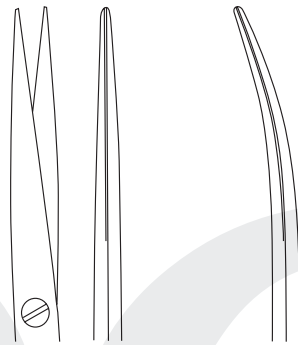

stumpf/stumpf
blunt/blunt



Metzenbaum, Fig. 1

S-förmig
S-shaped

18,0 cm	02-221-18
20,0 cm	02-221-20
23,0 cm	02-221-23

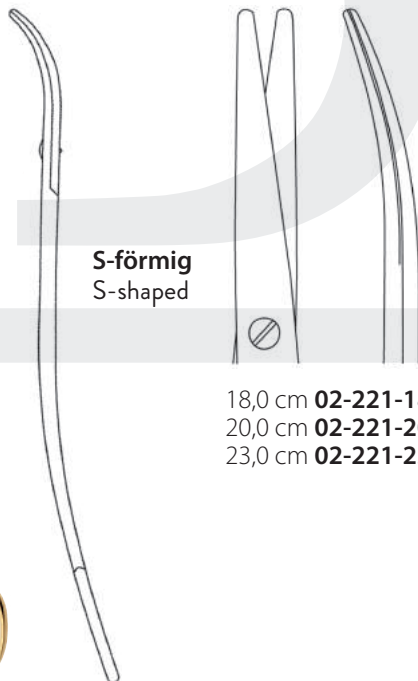

spitz/spitz
sharp/sharp



Metzenbaum, Fig. 3

S-förmig
S-shaped

18,0 cm	02-225-18
20,0 cm	02-225-20
23,0 cm	02-225-23

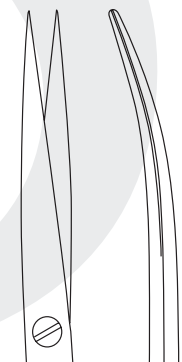



Mayo-Lexer



16,0 cm **02-230-16**
21,0 cm **02-230-21**



02-231-16
02-231-21



Lexer-Fino



16,0 cm **02-232-16**



02-233-16

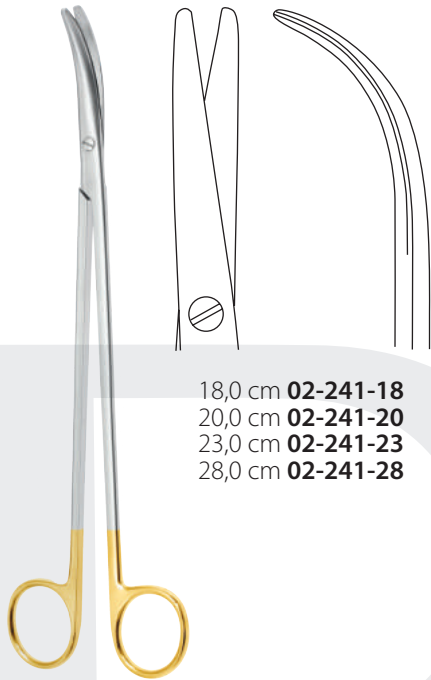

18,0 cm **02-241-18**
20,0 cm **02-241-20**
23,0 cm **02-241-23**
28,0 cm **02-241-28**

Metzenbaum-Thorek

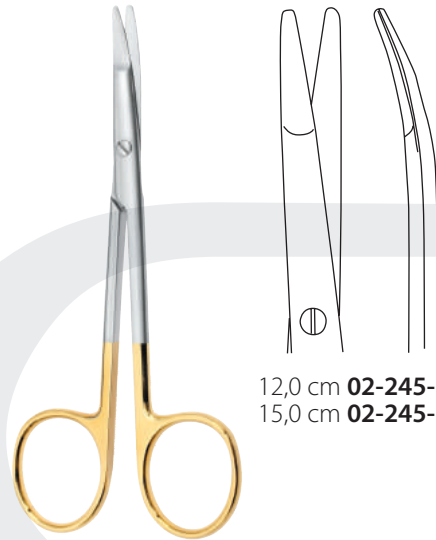

12,0 cm **02-245-12**
15,0 cm **02-245-15**

Kilner-Fino



TC-Reynolds
15,0 cm **02-249-15**
18,0 cm **02-249-18**



Metzenbaum-Lahey
14,0 cm **02-253-14**



Toennis-Adson
17,0 cm **02-253-17**

Tonsillen- und Nasenscheren
Tonsil and Nasal Scissors

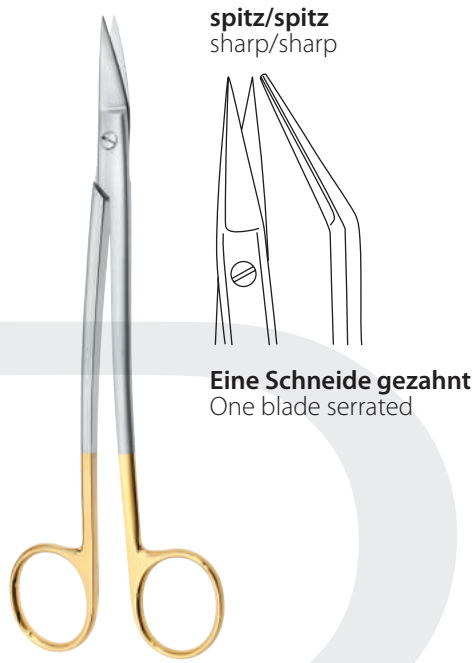

spitz/spitz
sharp/sharp

Eine Schneide gezahnt
One blade serrated

Dean
17,0 cm **02-305-17**

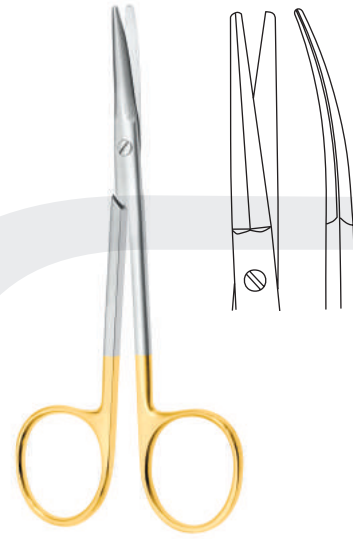

Fomon
13,0 cm **02-319-13**

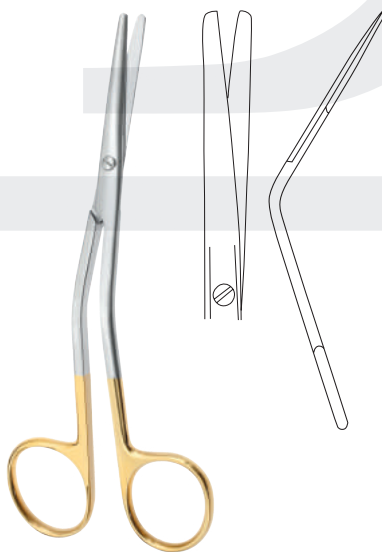

Fomon
13,0 cm **02-329-13**

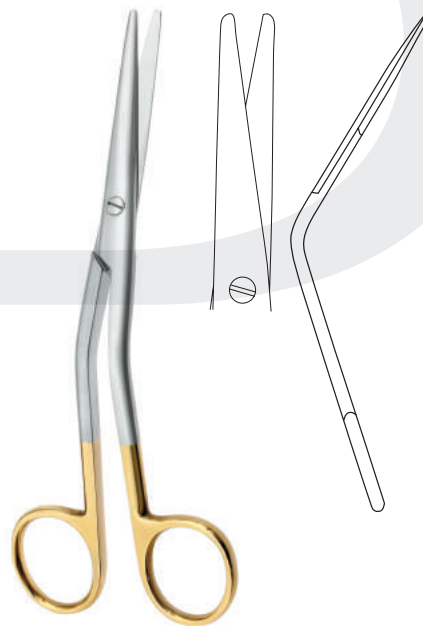

Cottle
16,0 cm **02-331-16**



16,0 cm **02-400-16** **02-401-16**

Kelly



14,0 cm **02-404-14** **02-405-14**

Joseph

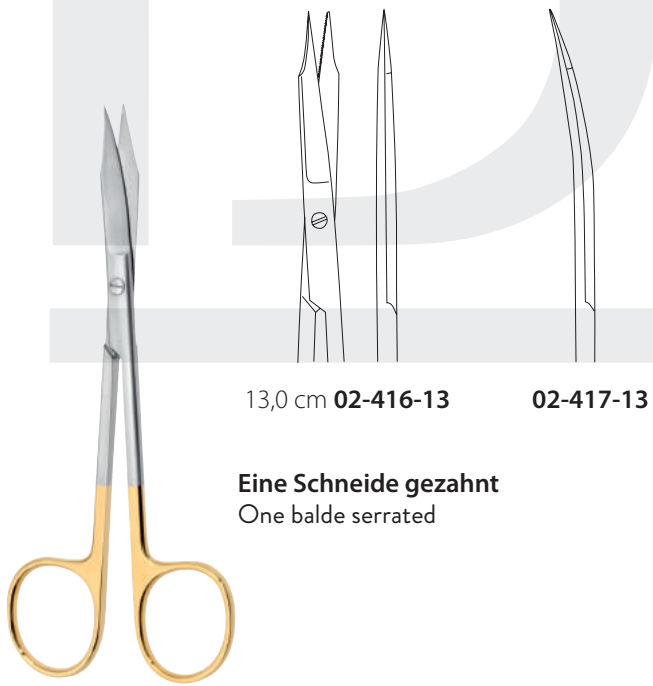

13,0 cm **02-416-13** **02-417-13**

Eine Schneide gezahnt
One blade serrated

Goldman-Fox

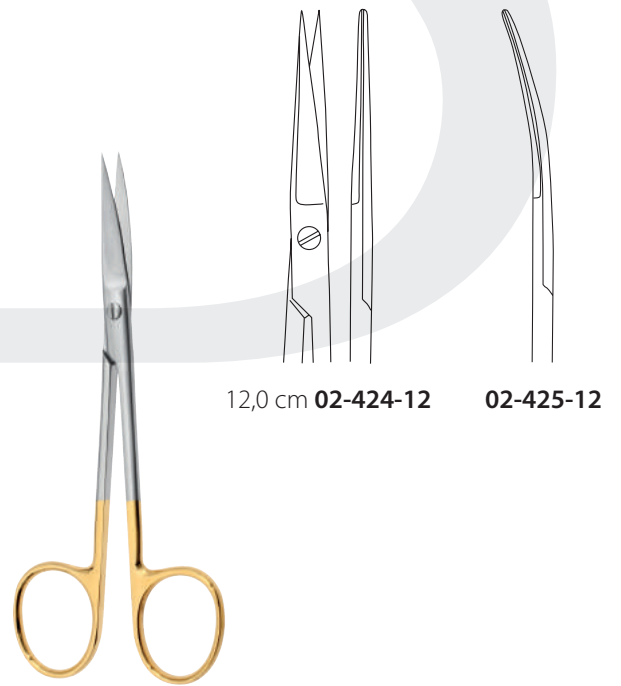

12,0 cm **02-424-12** **02-425-12**

Wagner



Feine Schere

11,0 cm 02-428-11

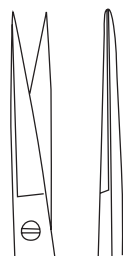

02-429-11

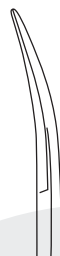

Iris

11,5 cm 02-436-11



02-437-11



Iris

11,5 cm 02-438-11

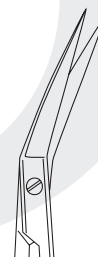

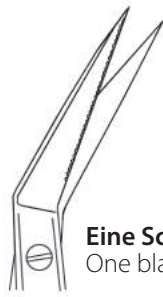

Eine Schneide gezahnt
One blade serrated

Locklin

16,0 cm **02-519-16**

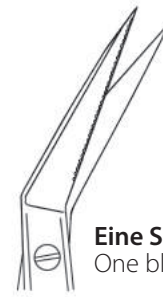
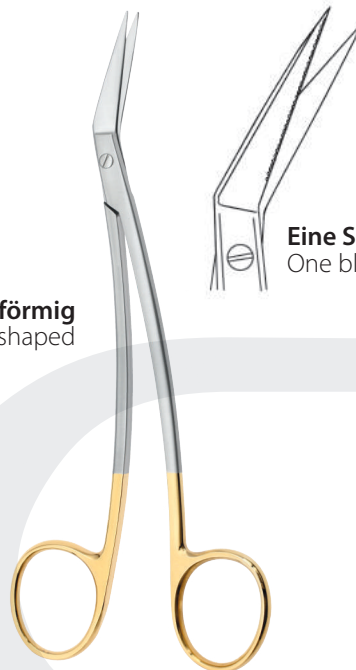

Eine Schneide gezahnt
One blade serrated

S-förmig
S-shaped

Locklin

02-521-16

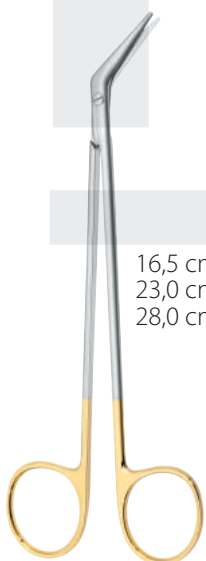

25°



45°

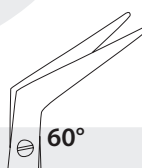

60°

16,5 cm	02-541-16	02-543-16	02-545-16
23,0 cm	02-541-23	02-543-23	02-545-23
28,0 cm	02-541-28	02-543-28	02-545-28

De Bakey

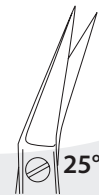

25°

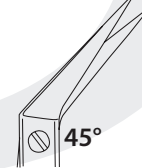

45°

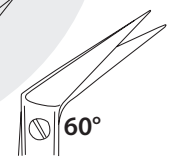

60°

19,0 cm	02-551-19	02-553-19	02-555-19
---------	------------------	------------------	------------------

Potts-Smith



Eine Schneide gezahnt
One blade serrated

Universal

12,0 cm **02-721-12**

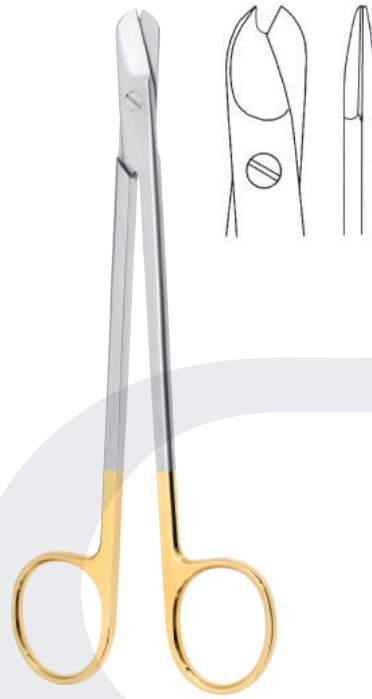

Smith

16,0 cm **02-724-16**



14,0 cm **02-731-14**
17,0 cm **02-731-17**
23,0 cm **02-731-23**

Mayo



mit Wellenschliff
with wave cutting edges

14,0 cm **02-733-14 W**
18,0 cm **02-733-18 W**
20,0 cm **02-733-20 W**
23,0 cm **02-733-23 W**
26,0 cm **02-733-26 W**

Metzenbaum

Pinzetten
Forceps

03





Standard

- 10,5 cm **03-000-10**
- 11,5 cm **03-000-11**
- 13,0 cm **03-000-13**
- 14,5 cm **03-000-14**
- 16,0 cm **03-000-16**
- 18,0 cm **03-000-18**
- 20,0 cm **03-000-20**
- 25,0 cm **03-000-25**
- 30,0 cm **03-000-30**



Standard

- 03-001-10**
- 03-001-11**
- 03-001-13**
- 03-001-14**
- 03-001-16**
- 03-001-18**
- 03-001-20**
- 03-001-25**
- 03-001-30**



**Standard
schmal
narrow**

- 03-002-11**
- 03-002-13**
- 03-002-14**
- 03-002-16**
- 03-002-18**
- 03-002-20**
- 03-002-25**
- 03-002-30**



**Standard
schmal
narrow**

- 03-003-11**
- 03-003-13**
- 03-003-14**
- 03-003-16**
- 03-003-18**
- 03-003-20**
- 03-003-25**
- 03-003-30**



**Standard
fein
delicate**

- 10,0 cm **03-004-10**
- 11,5 cm **03-004-11**
- 13,0 cm **03-004-13**
- 14,0 cm **03-004-14**
- 16,0 cm **03-004-16**
- 18,0 cm **03-004-18**
- 20,0 cm **03-004-20**



Schweden Modell
Sweden pattern

- 13,0 cm **03-006-13**
- 15,0 cm **03-006-15**
- 17,0 cm **03-006-17**
- 20,0 cm **03-006-20**



Mikroskopier Pinzette
Microscopic forceps

- 9,0 cm **03-008-09**
- 10,5 cm **03-008-10**
- 11,5 cm **03-008-11**
- 13,0 cm **03-008-13**
- 14,5 cm **03-008-14**



Mikroskopier Pinzette
Microscopic forceps

- 9,0 cm **03-009-09**
- 10,5 cm **03-009-10**
- 11,5 cm **03-009-11**
- 13,0 cm **03-009-13**
- 14,5 cm **03-009-14**

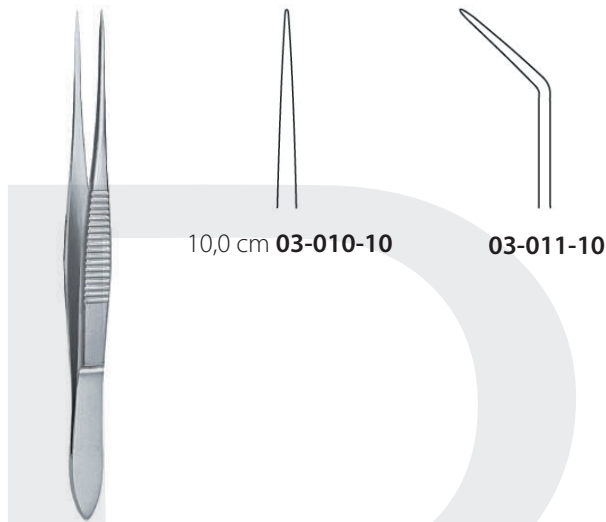

Mikroskopier Pinzette
Microscopic forceps

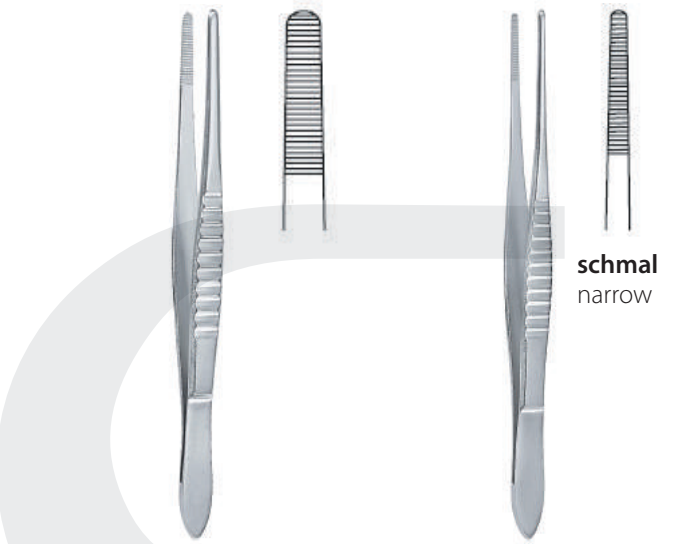

- Modell USA**
12,0 cm **03-020-12**
13,0 cm **03-020-13**
14,0 cm **03-020-14**
15,0 cm **03-020-15**
18,0 cm **03-020-18**
21,0 cm **03-020-21**
25,0 cm **03-020-25**
31,0 cm **03-020-31**

- Modell USA**
03-022-12
03-022-13
03-022-14
03-022-15

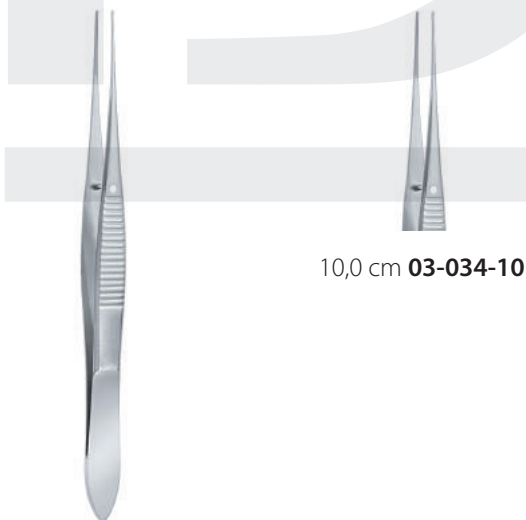

Feine anat. Pinzette
Delicate Dissecting Forceps





Ewald - Hudson
12,0 cm **03-040-12**
15,0 cm **03-040-15**



Adson
03-042-12
03-042-15



schmal
narrow



Adson
03-044-12
03-044-15



fein
delicate



Adson
03-046-12
03-046-15



mikro
micro



Adson
12,0 cm **03-047-12**



fein
delicate



McIndoe
03-050-15



Gillies
03-052-15



Gillies
03-053-15



Anatomische Pinzetten
Dressing Forceps



Semken

12,0 cm **03-054-12**
15,0 cm **03-054-15**



Semken

03-055-12
03-055-15



Taylor

17,5 cm **03-058-17**



03-059-17



Taylor

17,0 cm **03-061-17**



Mikro-Pinzette

Micro Forceps

0,6 mm



15,5 cm
03-060-06

0,8 mm



03-060-08

1,0 mm



03-060-10



Potts-Smith
18,0 cm **03-064-18**
21,0 cm **03-064-21**
25,0 cm **03-064-25**
30,0 cm **03-064-30**



Potts-Smith
03-065-18
03-065-21
03-065-25
03-065-30



Cushing
17,5 cm **03-066-17**



Cushing
17,5 cm **03-067-17**



Brophy
20,0 cm **03-068-20**



Brophy
20,0 cm **03-069-20**



Gerald
18,0 cm **03-070-18**
23,0 cm **03-070-23**



Gerald
18,0 cm **03-071-18**



Duval
14,5 cm **03-082-14**



Russ. Modell
15,0 cm **03-084-15**
20,0 cm **03-084-20**
25,0 cm **03-084-25**



Wangenstein
23,0 cm **03-086-23**



Tuttle
23,0 cm **03-088-23**



Standard
13,0 cm **03-092-13**
16,0 cm **03-092-16**

kreuzgerieft
cross serrated



Selmann
16,0 cm **03-094-15**
20,0 cm **03-094-20**
25,0 cm **03-094-25**



Standard

- 10,5 cm **03-100-10**
- 11,5 cm **03-100-11**
- 13,0 cm **03-100-13**
- 14,5 cm **03-100-14**
- 16,0 cm **03-100-16**
- 18,0 cm **03-100-18**
- 20,0 cm **03-100-20**
- 23,0 cm **03-100-23**
- 25,0 cm **03-100-25**
- 30,0 cm **03-100-30**



**Standard
schmal
narrow**

- 11,0 cm **03-102-11**
- 13,0 cm **03-102-13**
- 14,0 cm **03-102-14**
- 16,0 cm **03-102-16**
- 18,0 cm **03-102-18**
- 20,0 cm **03-102-20**
- 25,0 cm **03-102-25**
- 30,0 cm **03-102-30**



schmal, gebogen
narrow, curved

Standard

- 11,0 cm **03-103-11**
- 13,0 cm **03-103-13**
- 14,0 cm **03-103-14**
- 16,0 cm **03-103-16**
- 18,0 cm **03-103-18**
- 20,0 cm **03-103-20**
- 25,0 cm **03-103-25**
- 30,0 cm **03-103-30**



**Standard
fein
delicate**

- 13,0 cm **03-104-13**
- 14,0 cm **03-104-14**
- 16,0 cm **03-104-16**
- 20,0 cm **03-104-20**



Waugh

- 18,0 cm **03-106-18**
- 20,0 cm **03-106-20**
- 25,0 cm **03-106-25**
- 30,0 cm **03-106-30**



2:3

Standard USA

- 11,0 cm **03-120-11**
- 13,0 cm **03-120-13**
- 14,0 cm **03-120-14**
- 15,0 cm **03-120-15**
- 18,0 cm **03-120-18**
- 20,0 cm **03-120-20**
- 25,0 cm **03-120-25**
- 30,0 cm **03-120-30**



1:2

Standard USA

- 13,0 cm **03-122-13**
- 14,0 cm **03-122-14**
- 15,0 cm **03-122-15**
- 18,0 cm **03-122-18**
- 21,0 cm **03-122-21**
- 25,0 cm **03-122-25**
- 31,0 cm **03-122-31**



2:3

Standard

- 11,0 cm **03-124-11**
- 13,0 cm **03-124-13**
- 14,0 cm **03-124-14**
- 15,0 cm **03-124-15**
- 16,0 cm **03-124-16**
- 18,0 cm **03-124-18**
- 20,0 cm **03-124-20**
- 25,0 cm **03-124-25**
- 30,0 cm **03-124-30**



3:4

Standard

- 13,0 cm **03-126-13**
- 14,0 cm **03-126-14**
- 15,0 cm **03-126-15**
- 16,0 cm **03-126-16**



4:5

Standard

- 13,0 cm **03-128-13**
- 14,0 cm **03-128-14**
- 16,0 cm **03-128-16**

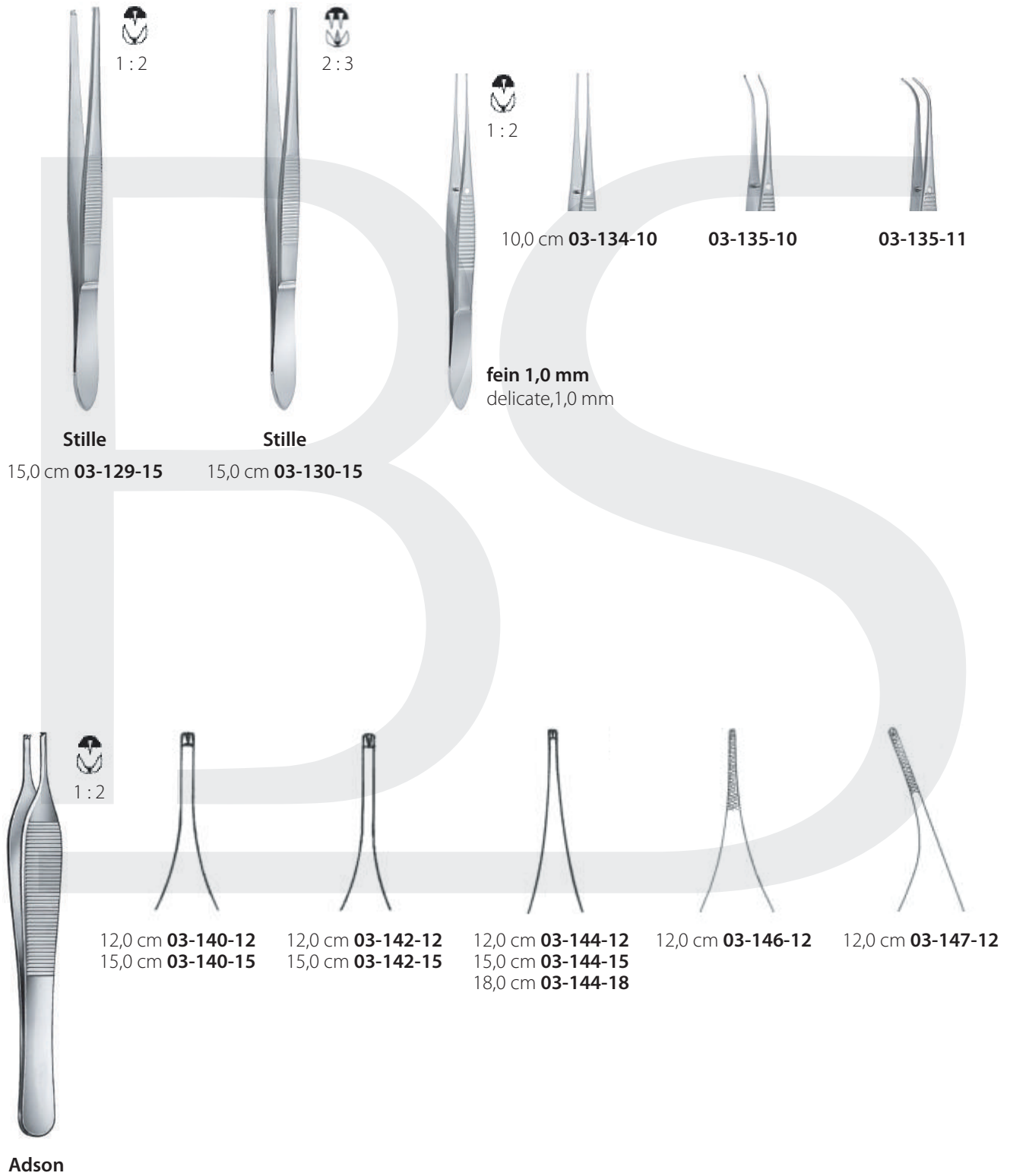



McIndoe
15,0 cm **03-150-15**



Gillies
03-152-15



Semken

12,0 cm **03-154-12**
15,0 cm **03-154-15**

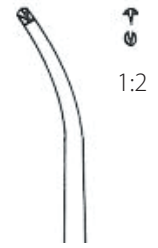

03-155-12
03-155-15



03-156-17

Taylor
17,5 cm



03-158-17

Taylor
17,5 cm

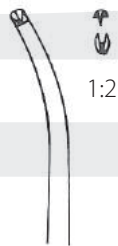

03-157-17

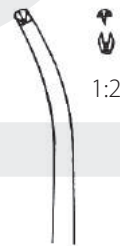

03-159-17

Mikro-Pinzette
15,0cm

1:2 0,6 mm 0,8 mm 1,0 mm
03-160-06 **03-160-08** **03-160-10**



1:2

Taylor, Bajonett
17,0 cm **03-161-17**



1:2

Potts-Smith
18,0 cm **03-164-18**
21,0 cm **03-164-21**
25,0 cm **03-164-25**
30,0 cm **03-164-30**



1:2

Potts-Smith
03-165-18
03-165-21
03-165-25
03-165-30



Cushing
17,0 cm **03-166-17**



Cushing
17,0 cm **03-167-17**



Brophy
20,0 cm **03-168-20**



Brophy
20,0 cm **03-169-20**



Gerald
18,0 cm **03-170-18**



Gerald
18,0 cm **03-171-18**

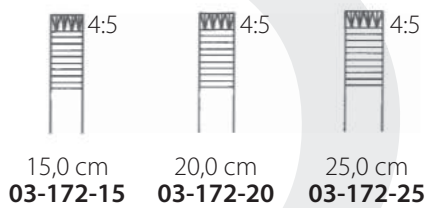
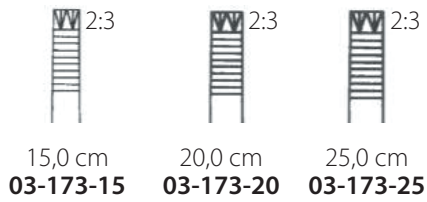

Adlerkreuz

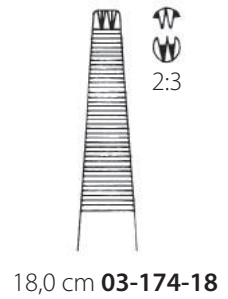
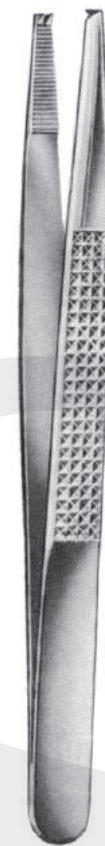

Bonney

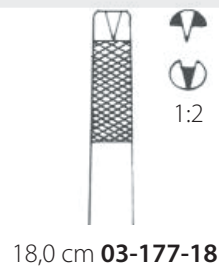

Ferris-Smith

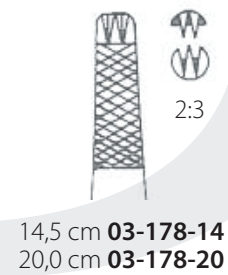

Lane



Duehrssen
20,0 cm **03-180-01**



Stille-Barraya
18,0 cm **03-182-18**
20,0 cm **03-182-20**
23,0 cm **03-182-23**
25,0 cm **03-182-25**



Nelson
23,0 cm **03-183-23**



Taylor-Brown
17,0 cm **03-185-17**



Cushing-Brown
17,0 cm **03-186-17**



Gerald-Brown
17,0 cm **03-187-17**



Brown
15,0 cm **03-188-15**
20,0 cm **03-188-20**
25,0 cm **03-188-25**



Adson-Brown
12,0 cm **03-190-12**



Adson-Brown
12,0 cm **03-191-12**
15,0 cm **03-191-15**



Adson
12,0 cm **03-192-12**



Stone
15,0 cm **03-194-15**



Lerche
03-196-15

Atraumatische Pinzetten

Atraumatic Tissue Forceps

De Bakey

1,0 mm	16,0 cm 03-212-16	03-210-16	03-208-16
	20,0 cm 03-212-20	03-210-20	03-208-20
	24,0 cm 03-212-24	03-210-24	03-208-24
	30,0 cm 03-212-30	03-210-30	03-208-30
1,5 mm			
2,0 mm			
2,4 mm	16,0 cm 03-206-16	03-204-16	03-200-16
	20,0 cm 03-206-20	03-204-20	03-200-20
	24,0 cm 03-206-24	03-204-24	03-200-24
	30,0 cm 03-206-30	03-204-30	03-200-30
2,8 mm			
3,5 mm			
1,5 mm	16,0 cm 03-211-16	03-209-16	
	20,0 cm 03-211-20	03-209-20	
	24,0 cm 03-211-24	03-209-24	
	30,0 cm 03-211-30	03-209-30	
2,0 mm			

De Bakey

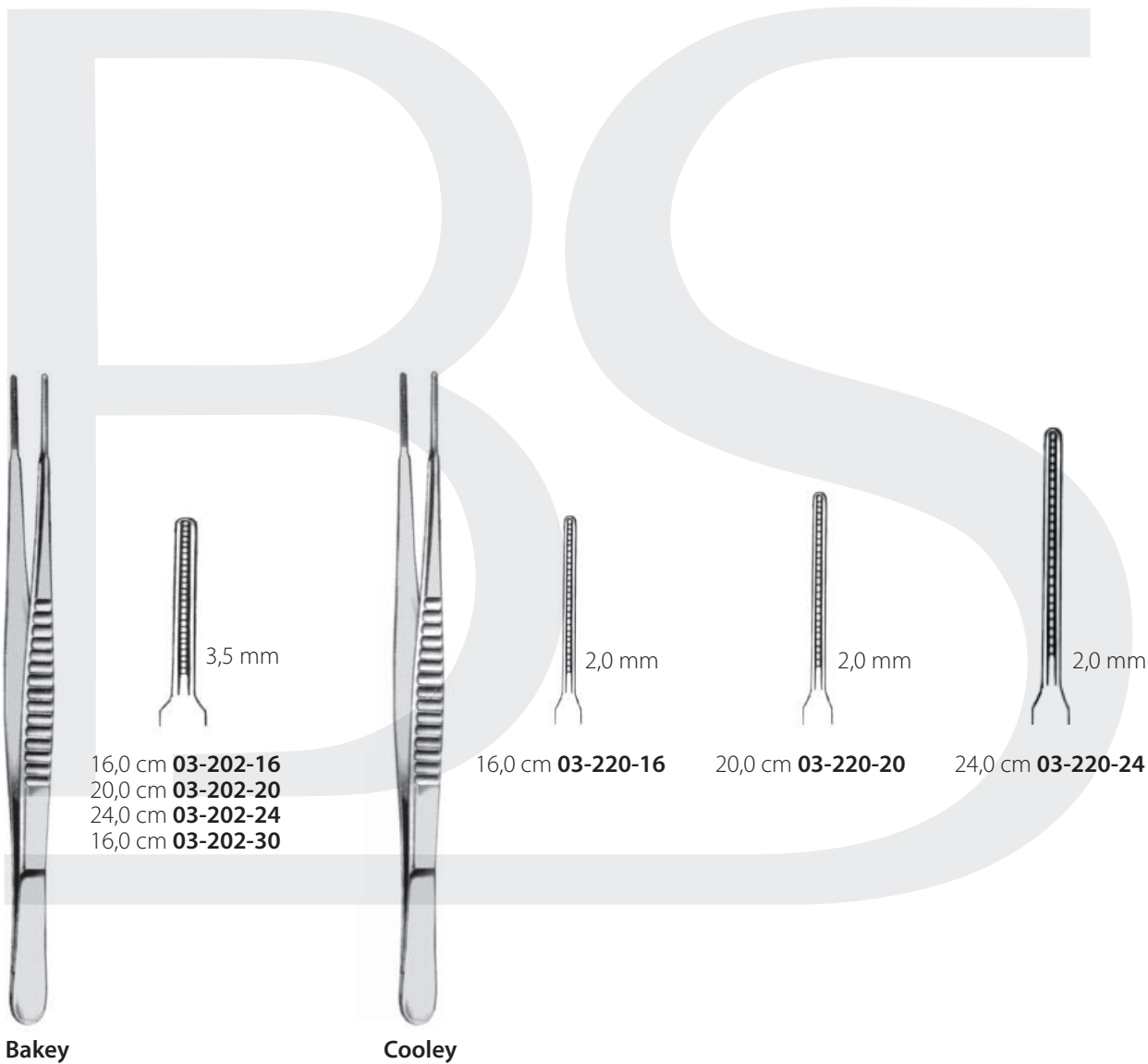

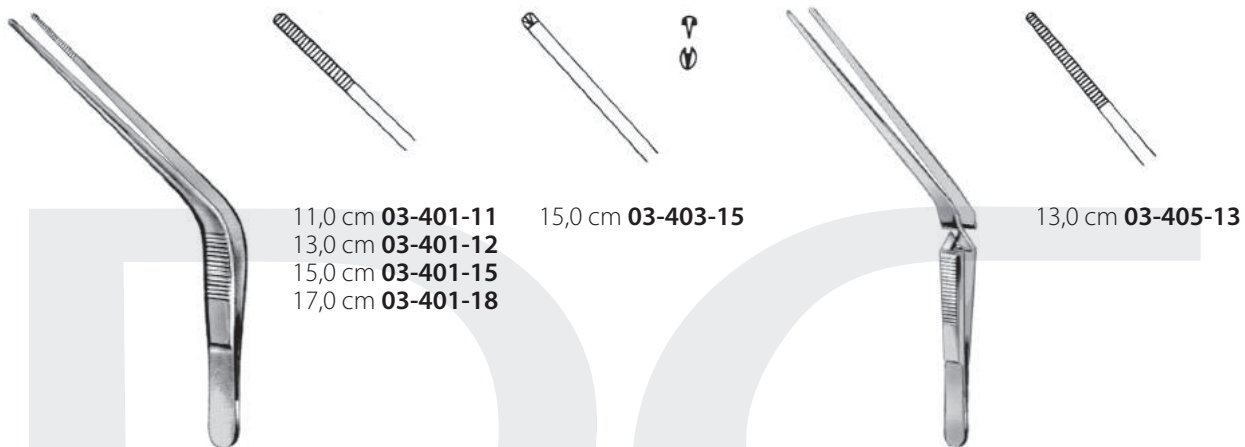

Trölsch

11,0 cm **03-401-11**
13,0 cm **03-401-12**
15,0 cm **03-401-15**
17,0 cm **03-401-18**

15,0 cm **03-403-15**

13,0 cm **03-405-13**

Trölsch (Wilde)

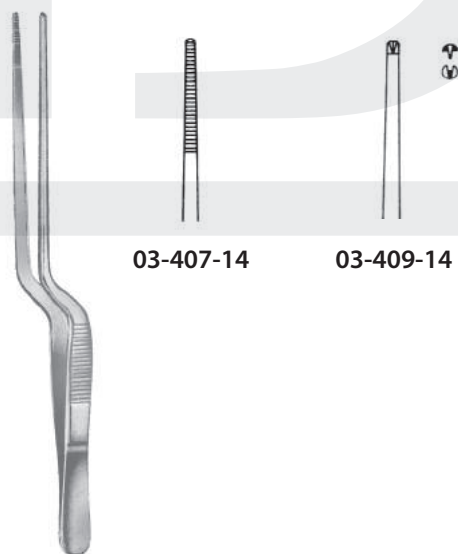

Lucae
14,0 cm

03-407-14

03-409-14

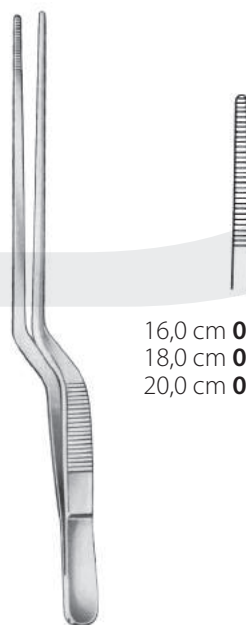

Jansen

16,0 cm **03-411-16**
18,0 cm **03-411-18**
20,0 cm **03-411-20**



Gerald

17,5 cm **03-413-18**



Gerald

17,5 cm **03-415-18**



1:2



Grünwald-Jansen



20,0 cm **03-417-20**



20,0 cm **03-419-20**
16,0 cm **03-422-16**

Cilien- u. Splitterpinzetten

Cilia and Splinter Forceps



Douglas

9,0 cm **03-500-09**



Shaaf

03-502-09



Beer

03-504-09



Cilien

03-508-09



Littauer

8,5 cm **03-510-08**



Barraquer

10,5 cm **03-511-10**



Splinterpinzette

Splinter Forceps

8,0 cm	03-512-08	03-513-08
9,0 cm	03-512-09	03-513-09
10,5 cm	03-512-10	03-513-10
11,5 cm	03-512-11	03-513-11
12,5 cm	03-512-12	03-513-12
14,0 cm	03-512-14	03-513-14



8,0 cm **03-514-08**
9,0 cm **03-514-09**
10,5 cm **03-514-10**
11,5 cm **03-514-11**
12,5 cm **03-514-12**
14,0 cm **03-514-14**

Splitterpinzette
Splinter Forceps



03-515-08
03-515-09
03-515-10
03-515-11
03-515-12
03-515-14



Carmalt
10,5 cm



03-516-10



Hunter
10,5 cm



03-518-10



03-517-10



03-519-10



Feilchenfeld
7,5 cm **03-522-07**
9,0 cm **03-522-09**
11,5 cm **03-522-11**



Uhrmacherpinzetten
11,0 cm **03-524-11**

-Nr. 4



Uhrmacherpinzetten
11,5 cm **03-524-12**

-Nr. 3



Uhrmacherpinzetten
11,5 cm **03-525-12**

-Nr. 7



Splitterpinzette mit Lupe
Splinter Forceps with
magnifying glass
12,0 cm **03-528-12**

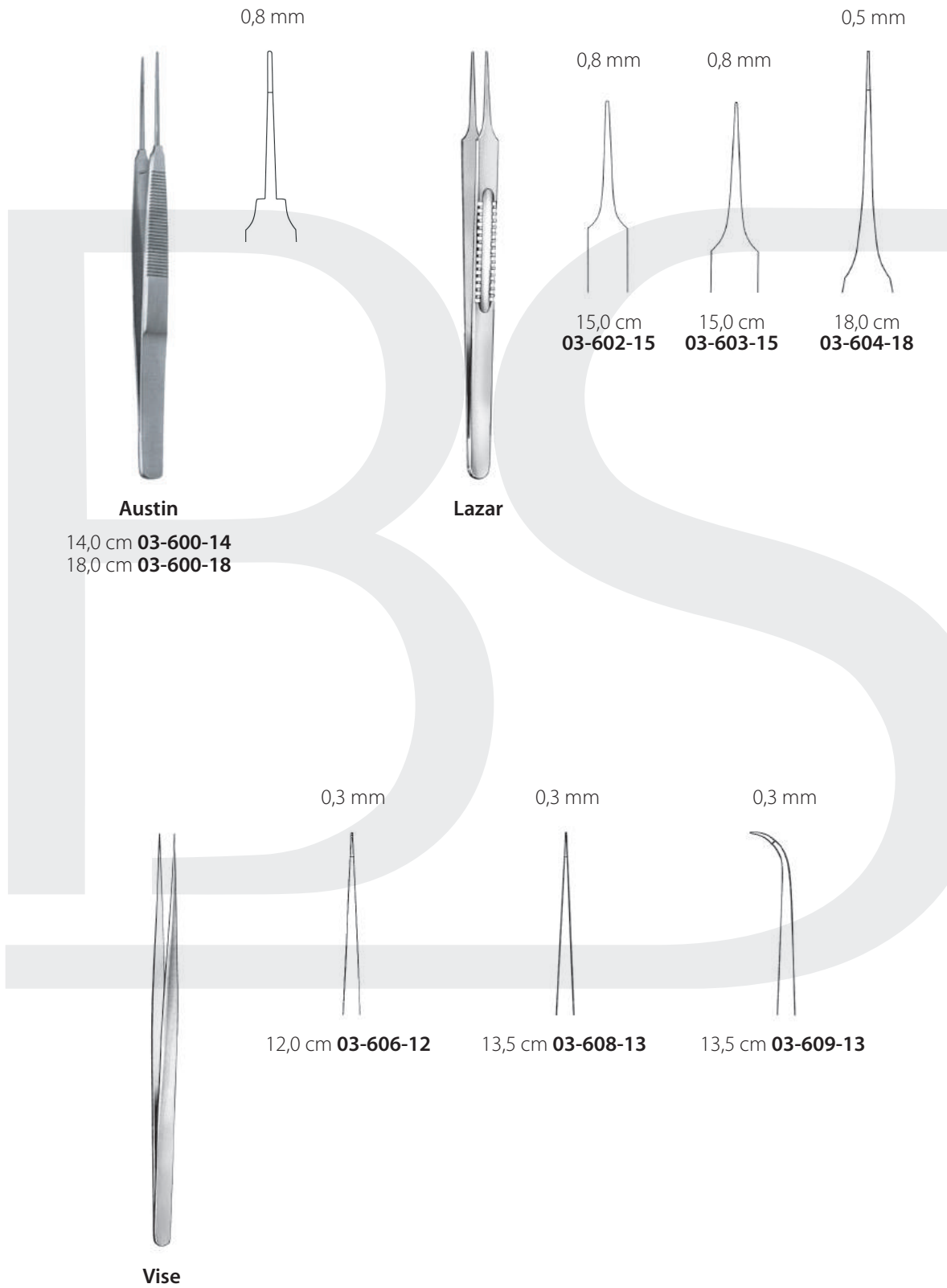

0,3 mm

0,3 mm

0,6 mm

0,6 mm



12,0 cm	03-304-12	03-305-12
15,0 cm	03-304-15	03-305-15
18,0 cm	03-304-18	03-305-18
21,0 cm	03-304-21	03-305-21



15,0 cm	03-306-15	03-307-15
18,0 cm	03-306-18	03-307-18
21,0 cm	03-306-21	03-307-21
23,0 cm	03-306-23	03-307-23

Knüpfpinzette
Suture Tying Forceps

Knüpfpinzette
Suture Tying Forceps



9,0 cm **03-614-09**
11,0 cm **03-614-11**

Mikro-Knüpfpinzette
Micro Suture Tying Forceps

0,3 mm 0,6 mm 0,6 mm

03-620-01 03-620-02 03-620-03

Hunt, bajonett
18,5 cm

0,6 mm 0,9 mm 1x2

16,0 cm **03-621-16** **03-623-16**
18,0 cm **03-621-18** **03-623-18**
20,0 cm **03-621-20** **03-623-20**
22,0 cm **03-621-22** **03-623-22**
24,0 cm **03-621-24** **03-623-24**

03-624-18

Yasargil, bajonett



ø 3 mm
⊙
03-625-24

ø 5 mm
⊙
03-627-24

ø 7 mm
⊙
03-629-24

Yasargil-Samii
24,0 cm



ø 3 mm
⊙
03-631-22

ø 5 mm
⊙
03-633-22

ø 3 mm
⊙
03-635-22

ø 5 mm
⊙
03-637-22

Yasargil-Samii
22,0 cm



ø 3 mm
⊙
03-639-22

ø 5 mm
⊙
03-641-22

Heifetz
22,0 cm

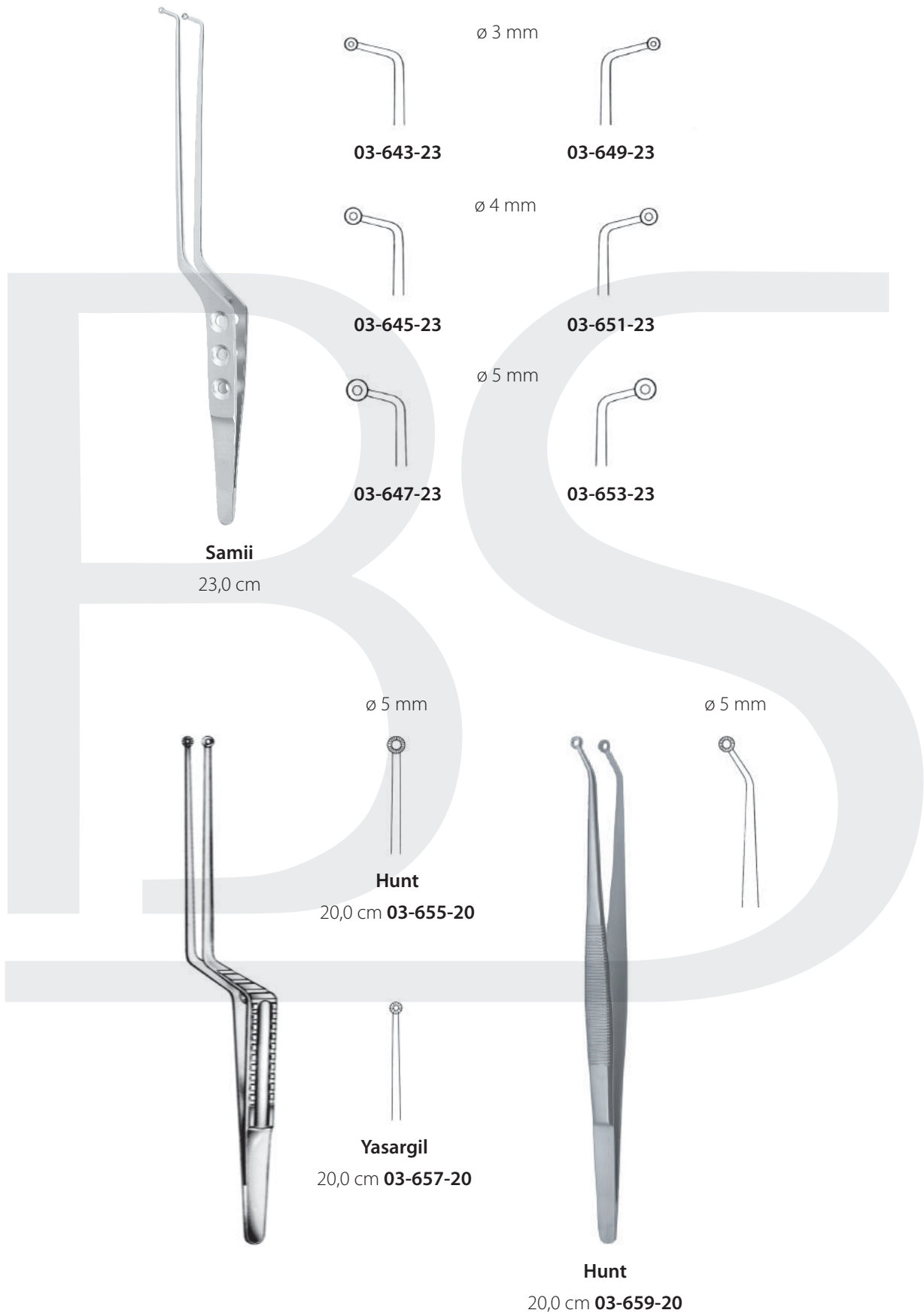

Samii
23,0 cm

03-643-23

ø 3 mm

03-649-23

03-645-23

ø 4 mm

03-651-23

03-647-23

ø 5 mm

03-653-23

ø 5 mm

Hunt

20,0 cm **03-655-20**

ø 5 mm

Yasargil

20,0 cm **03-657-20**

Hunt

20,0 cm **03-659-20**

TC-Pinzetten
TC-Forceps

04





Standard

14,0 cm **04-002-14**
20,0 cm **04-002-20**
25,0 cm **04-002-25**



**Standard
fein
fine**

14,0 cm **04-004-14**
18,0 cm **04-004-18**
20,0 cm **04-004-20**
25,0 cm **04-004-25**



Adson

12,0 cm **04-044-12**
15,0 cm **04-044-15**



Mc Indoe

15,0 cm **04-050-15**



Semken

12,0 cm **04-054-12**
15,0 cm **04-054-15**



Taylor

18,0 cm **04-061-18**



Potts-Smith

15,0 cm **04-064-15**
18,0 cm **04-064-18**
20,0 cm **04-064-20**
23,0 cm **04-064-23**
25,0 cm **04-064-25**



Cushing

18,0 cm **04-066-18**
23,0 cm **04-066-23**



18,0 cm **04-067-18**

TC-Pinzetten
TC-Dissecting Forceps



Gerald

18,0 cm **04-070-18**



Bonney

18,0 cm **04-075-18**



Wangenstein

15,0 cm **04-086-15**
23,0 cm **04-086-23**
25,0 cm **04-086-25**



1:2

Oehler

14,0 cm **04-102-14**
16,0 cm **04-102-16**
18,0 cm **04-102-18**
20,0 cm **04-102-20**
25,0 cm **04-102-25**



1:2

Adson

12,0 cm **04-142-12**
15,0 cm **04-142-15**



1:2

**Adson
fein
fine**

12,0 cm **04-144-12**
15,0 cm **04-144-15**



1:2

Gillies

15,0 cm **04-152-15**



1:2

Semken

15,0 cm **04-154-15**

18,0 cm **04-154-18**

fein
fine
16,0 cm **04-156-16**

fein
fine
18,0 cm **04-156-18**

1:2



Gerald

18,0 cm **04-170-18**

1:2



Bonney

18,0 cm **04-175-18**

1:2



Ferris-Smith

18,0 cm **04-176-18**

7:7



Adson-Brown

12,0 cm **04-191-12**

2,0 mm



De Bakey



16,0 cm
04-208-16



20,0 cm
04-208-20



24,0 cm
04-208-24

1,5 mm



De Bakey



16,0 cm
04-210-16



20,0 cm
04-210-20



24,0 cm
04-210-24

Klemmen
Forceps, Clamps, Clips

05





Rochester-Péan

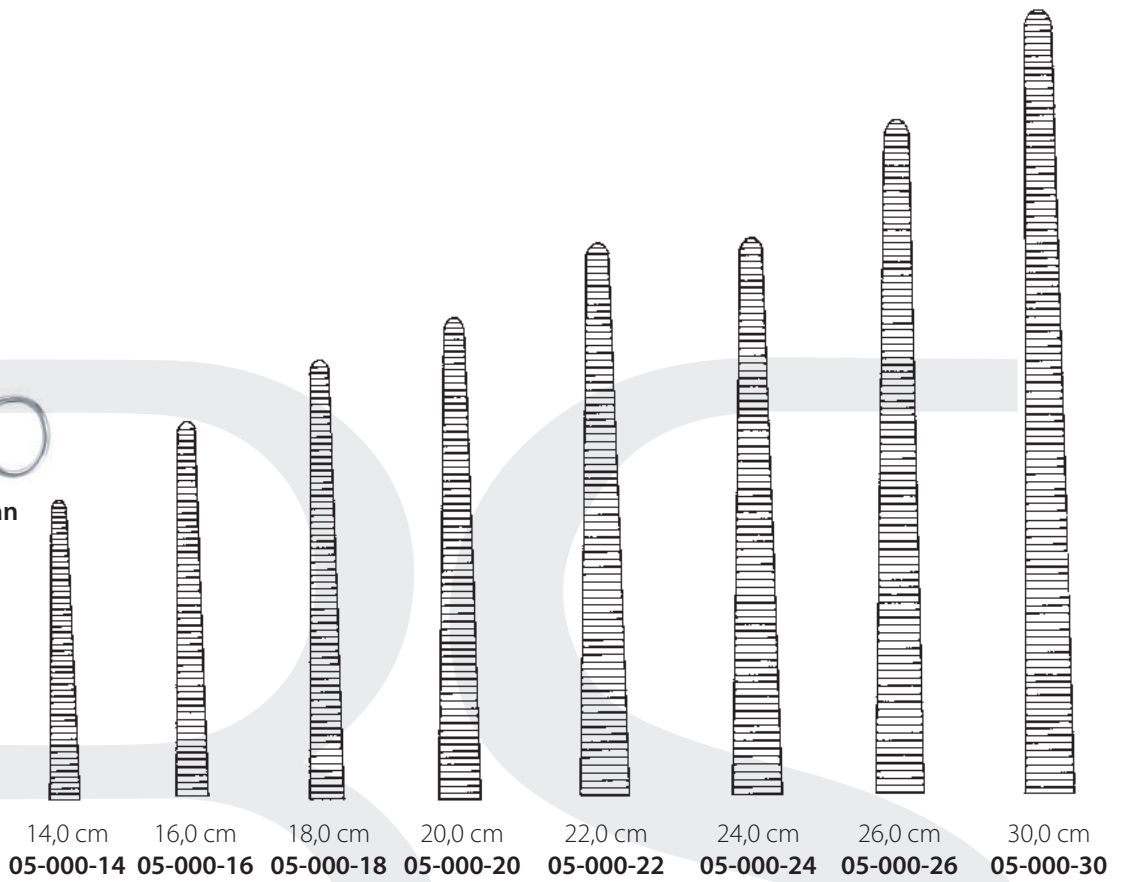

Rochester-Péan

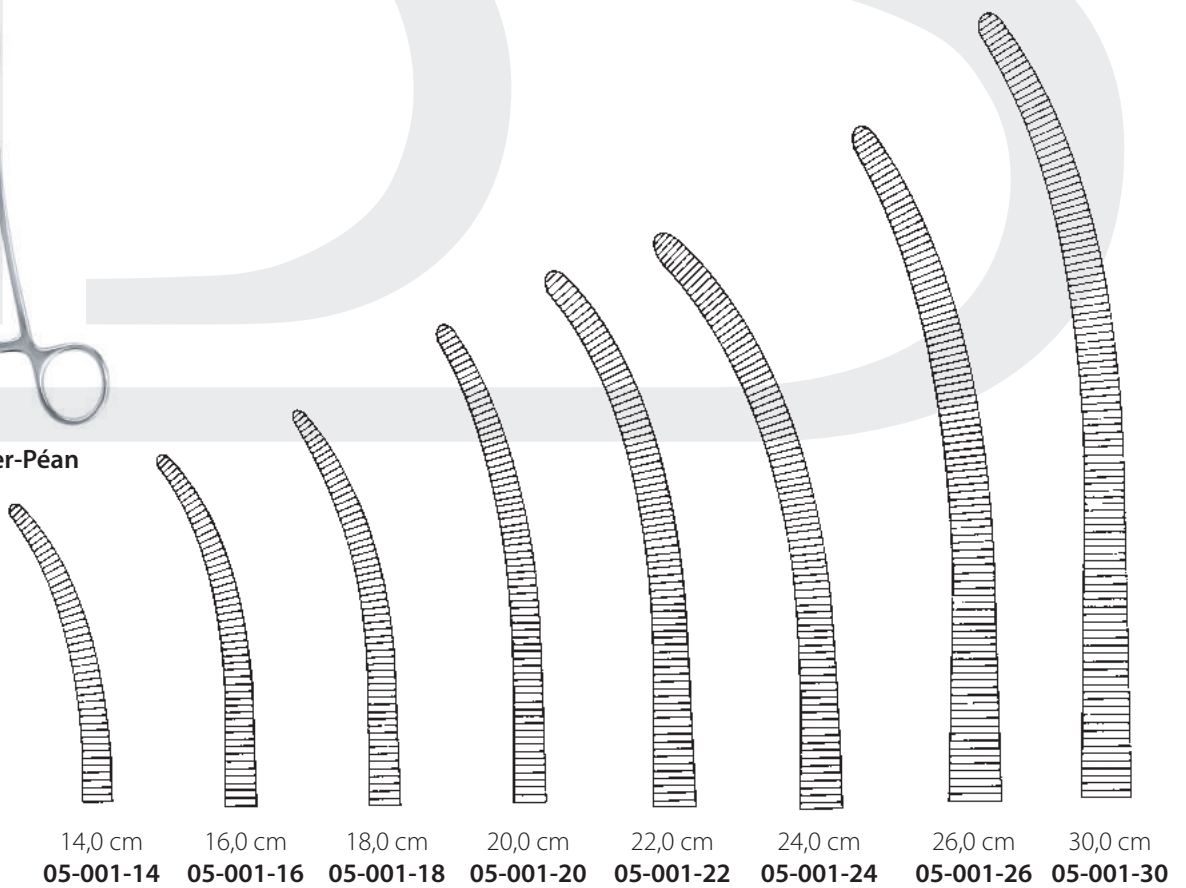

Arterienklemmen
Haemostatic Forceps



14,0 cm **05-004-14**
16,0 cm **05-004-16**
18,0 cm **05-004-18**

Péan-Nippon



14,0 cm **05-005-14**
16,0 cm **05-005-16**
18,0 cm **05-005-18**

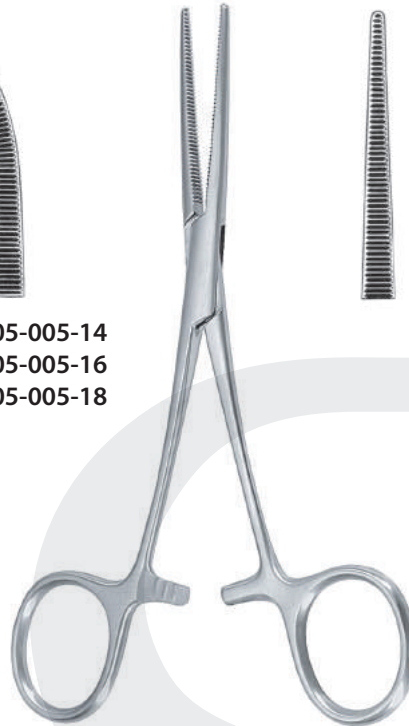

13,0 cm **05-011-13**
14,0 cm **05-011-14**
16,0 cm **05-011-16**

Péan, grazil

13,0 cm **05-010-13**
14,0 cm **05-010-14**
16,0 cm **05-010-16**

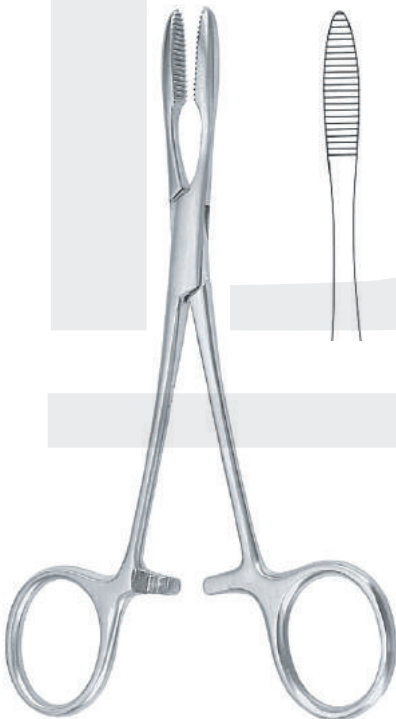

Péan
12,0 cm **05-012-12**
14,0 cm **05-012-14**
16,0 cm **05-012-16**



Spencer-Wells
13,0 cm **05-014-13**
14,0 cm **05-014-14**
15,0 cm **05-014-15**
18,0 cm **05-014-18**
20,0 cm **05-014-20**

13,0 cm **05-015-13**
14,0 cm **05-015-14**
15,0 cm **05-015-15**
18,0 cm **05-015-18**
20,0 cm **05-015-20**



21,0 cm **05-018-21** **05-019-21**
26,0 cm **05-018-26** **05-019-26**

Toennis

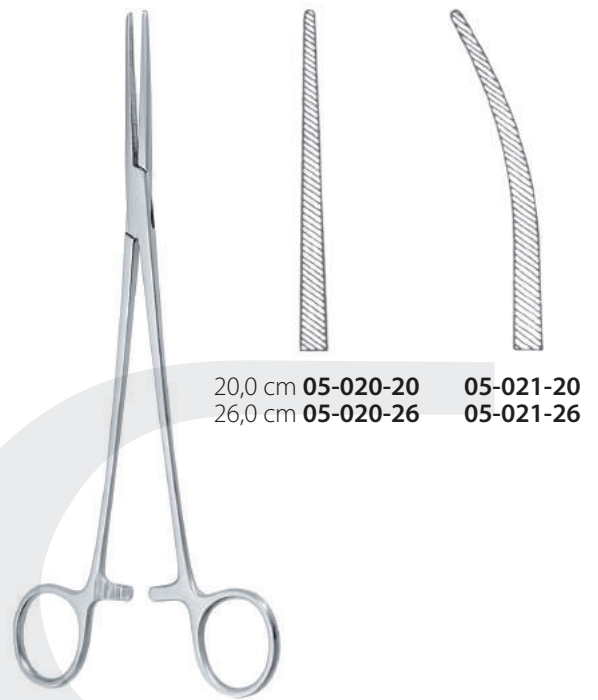

20,0 cm **05-020-20** **05-021-20**
26,0 cm **05-020-26** **05-021-26**

Bengolea

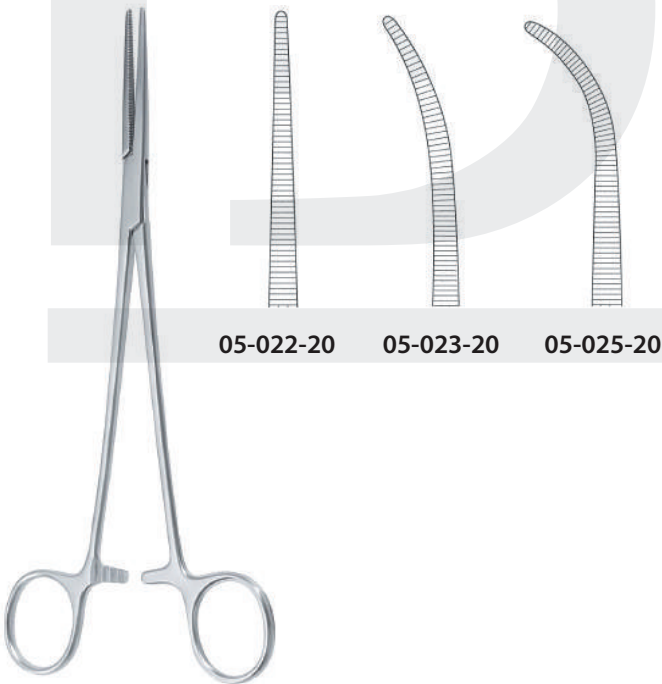

05-022-20 **05-023-20** **05-025-20**

Heiss
20,0 cm

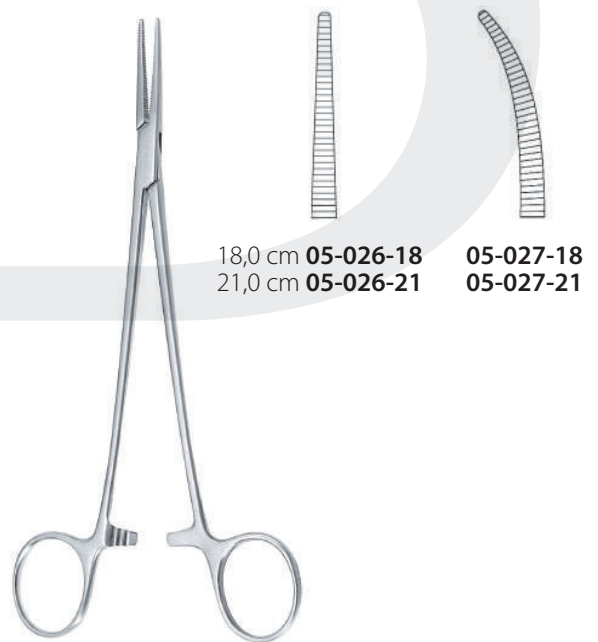

18,0 cm **05-026-18** **05-027-18**
21,0 cm **05-026-21** **05-027-21**

Halsted-Mosquito

Arterienklemmen
Haemostatic Forceps

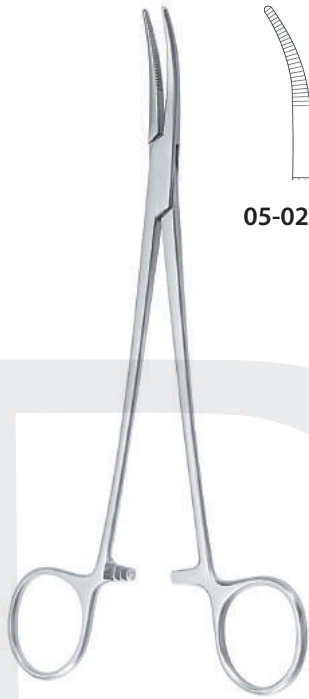

05-029-18

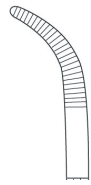

05-029-19

Schnidt
19,0 cm

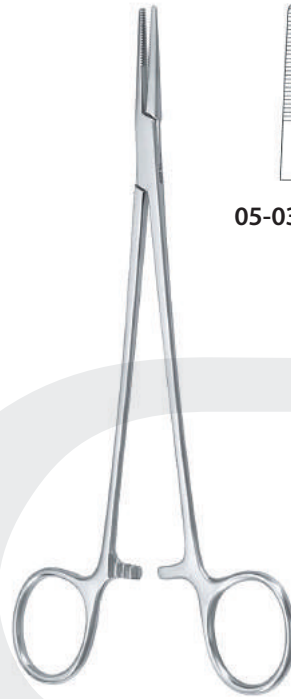

05-030-18



05-031-19

Adson
18,5 cm



Mikro-Adson
14,0 cm 05-033-14



Rochester-Carmalt



16,0 cm
05-034-16



20,0 cm
05-034-20



16,0 cm
05-035-16



20,0 cm
05-035-20



15,0 cm **05-036-15** **05-037-15**
18,5 cm **05-036-18** **05-037-18**

Brainbridge



05-038-16 **05-039-16**

Crile-Rankin
16,0 cm

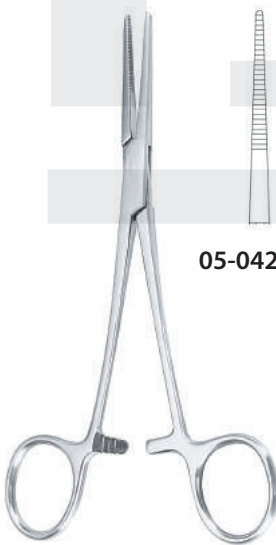

05-042-16 **05-043-16**

Kelly-Rankin
16,0 cm



Dixon-Lovelace
15,0 cm **05-044-15**



Fuchsig
20,0 cm **05-045-20**

Arterienklemmen
Haemostatic Forceps

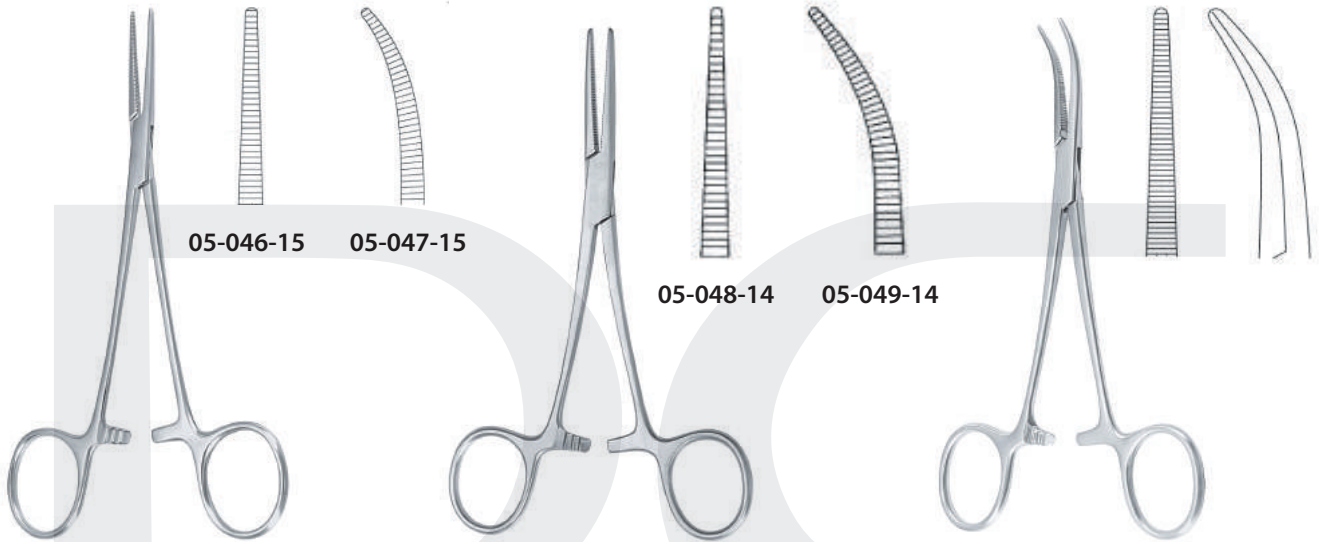

05-046-15 05-047-15

05-048-14 05-049-14

Leriche
15,0 cm

Crile
14,0 cm

Dandy
12,0 cm **05-051-12**
14,0 cm **05-051-14**

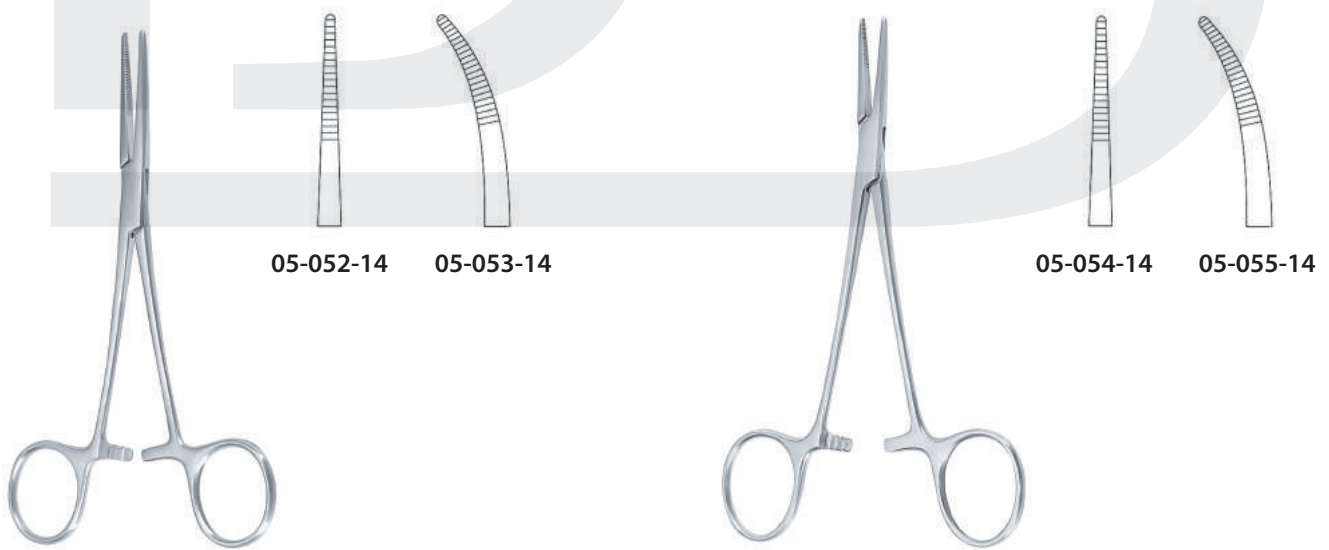

05-052-14 05-053-14

05-054-14 05-055-14

Kelly
14,0 cm

Providence-Hospital
14,0 cm

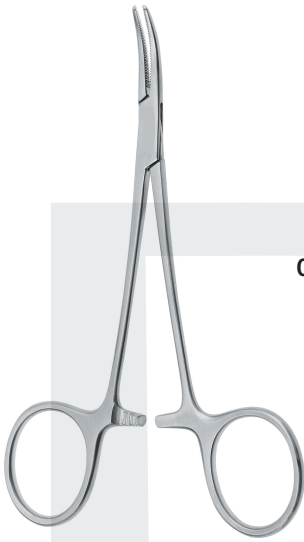

Halsted-Mosquito

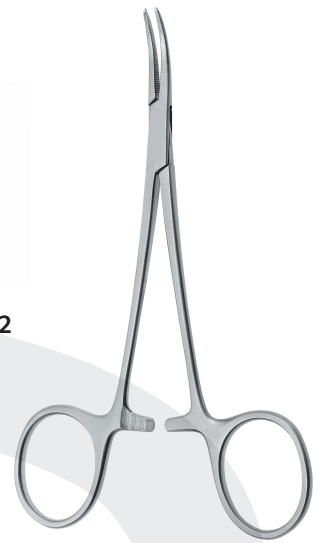
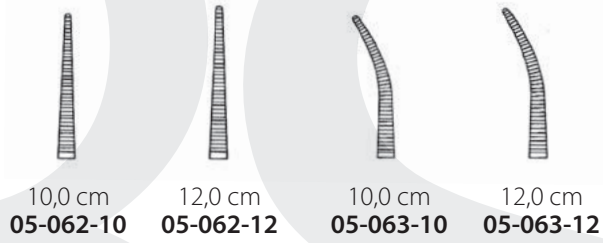
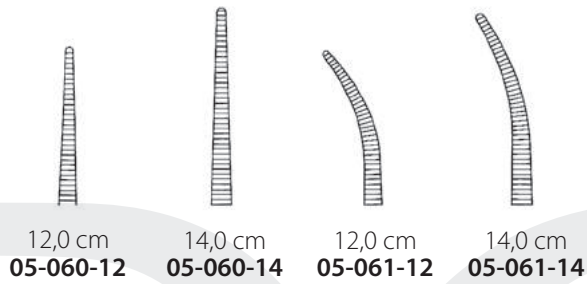

Mikro-Mosquito



Hartmann
10,0 cm

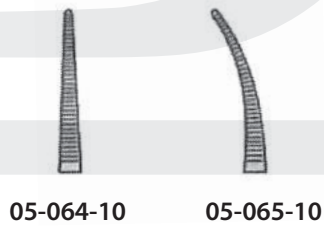

Krönlein
13,0 cm 05-072-13

Arterienklemmen
Haemostatic Forceps

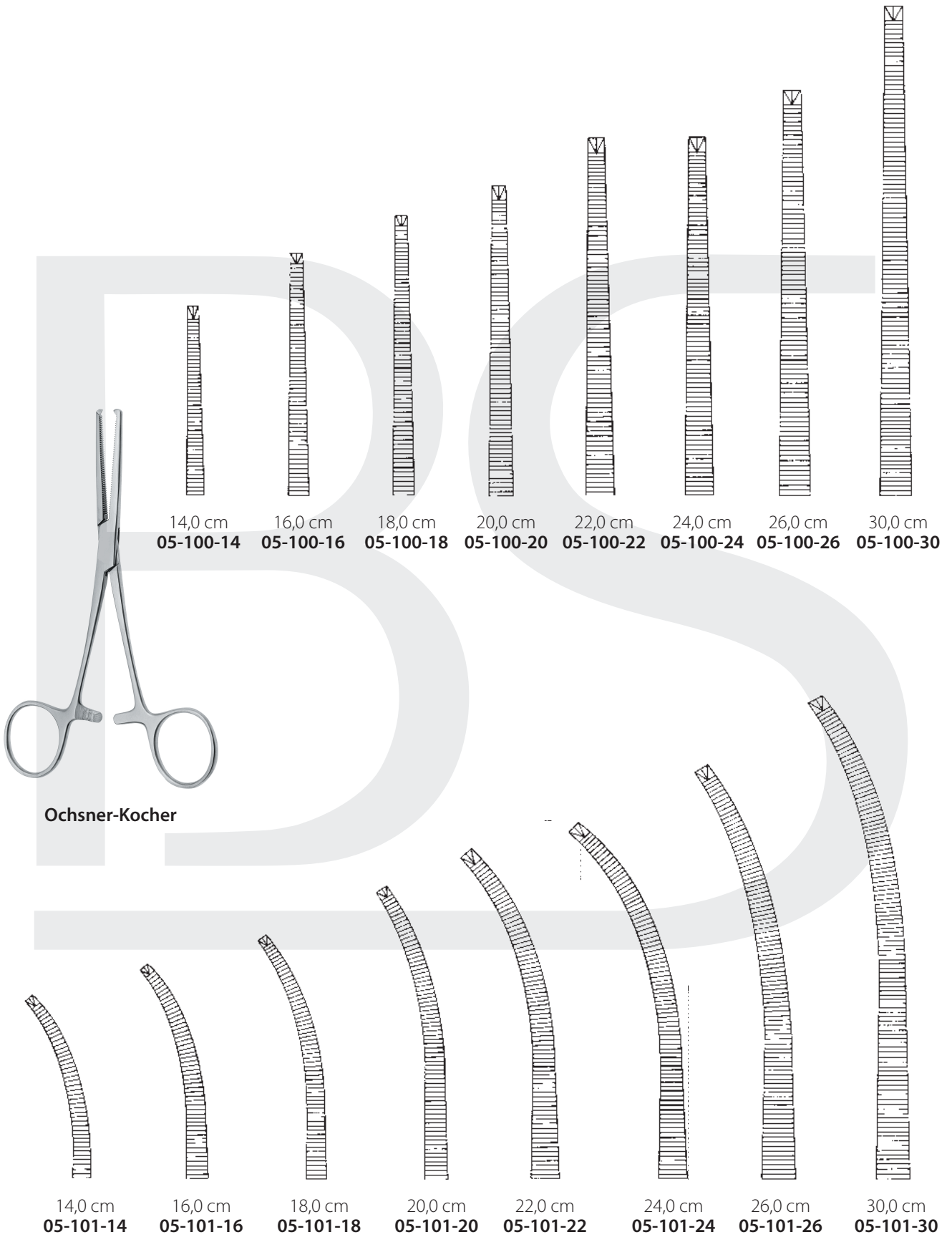

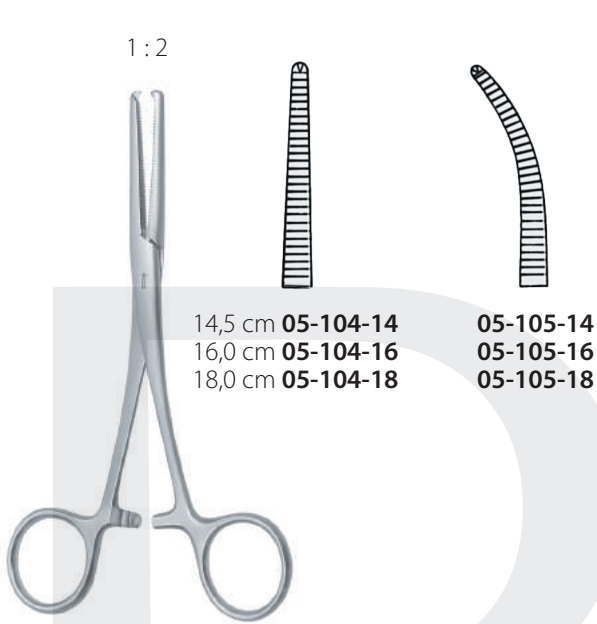

Kocher-Nippon

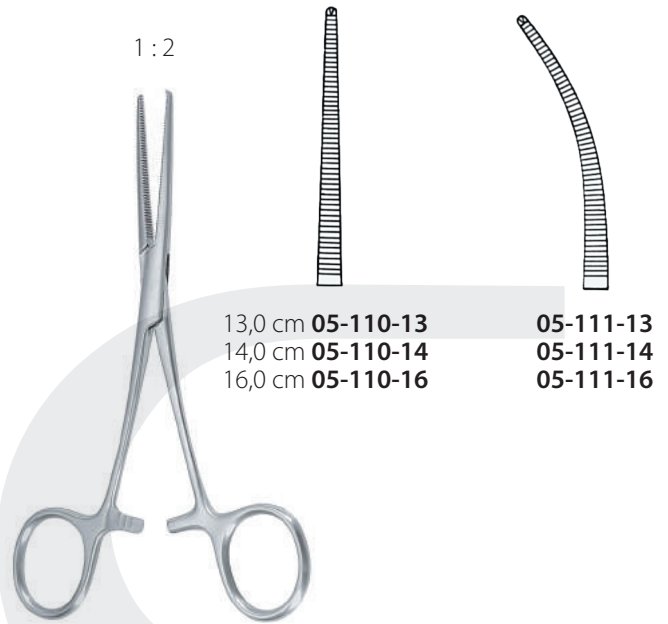

Kocher
fein/fine

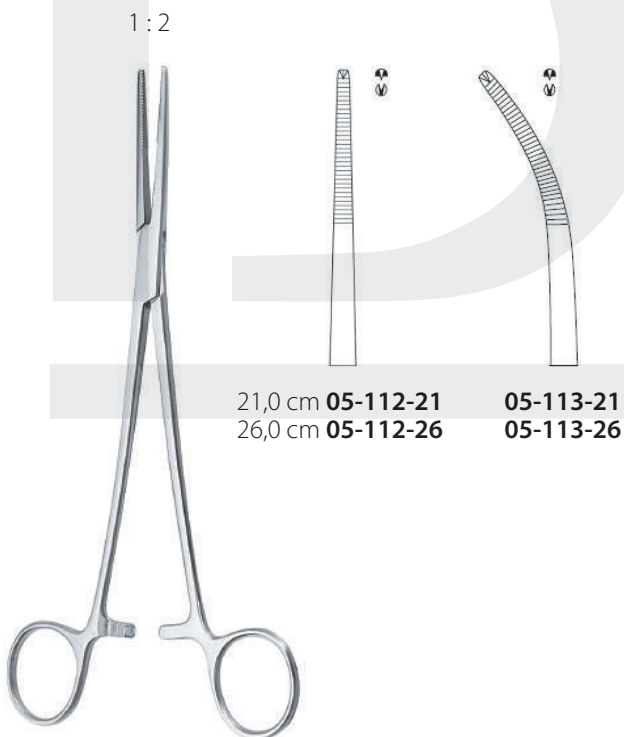

Toennis



Bengolea

Arterienklemmen
Haemostatic Forceps

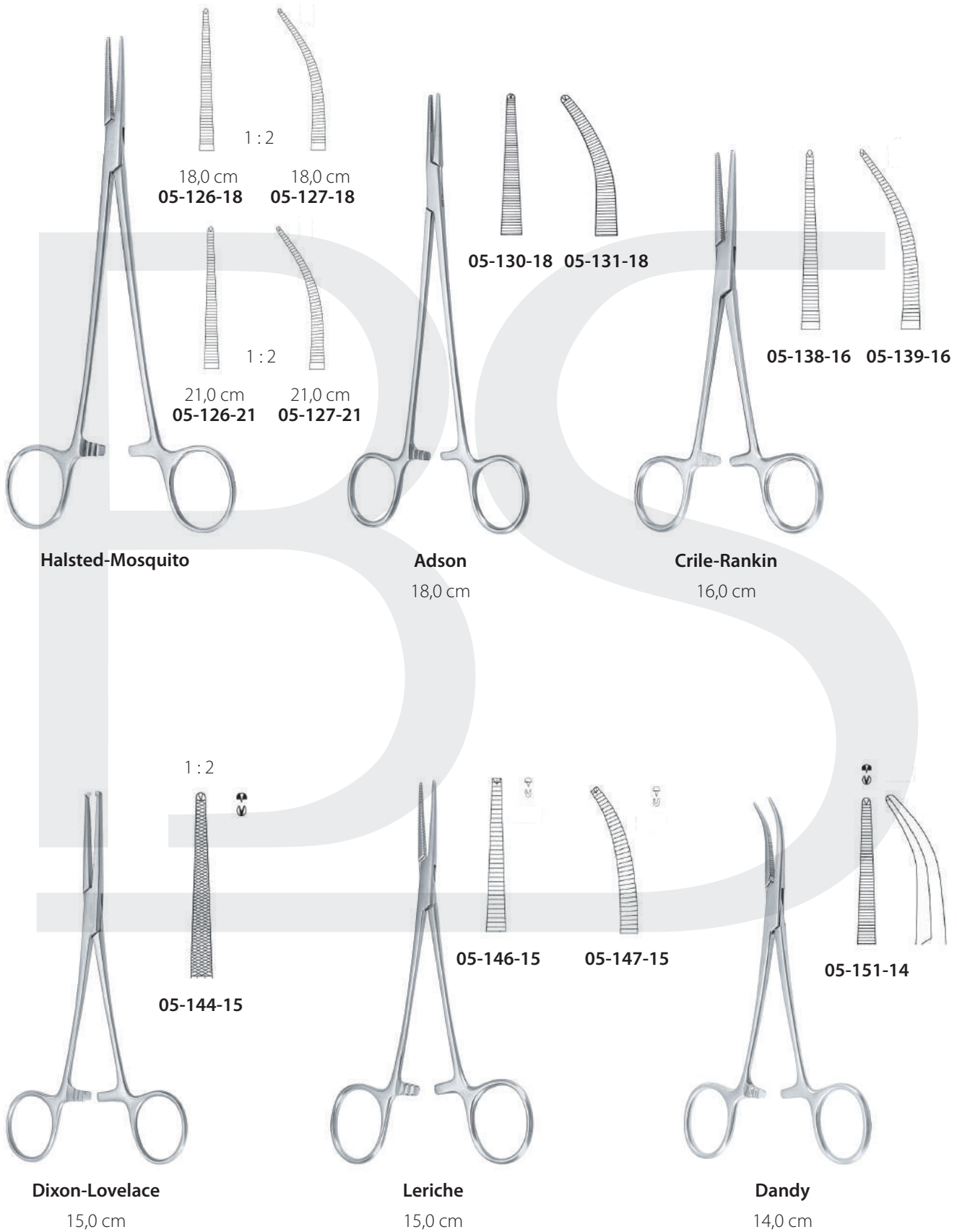



Available in Titanium

Halsted-Mosquito



12,5 cm
05-160-12



14,0 cm
05-160-14



12,5 cm
05-161-12



14,0 cm
05-161-14



10,0 cm
05-162-10



12,0 cm
05-162-12



10,0 cm
05-163-10



12,0 cm
05-163-12



Mikro-Mosquito



Terrier

8,5 cm 05-166-08



1:2

Präparierklemmen
Dissecting Forceps

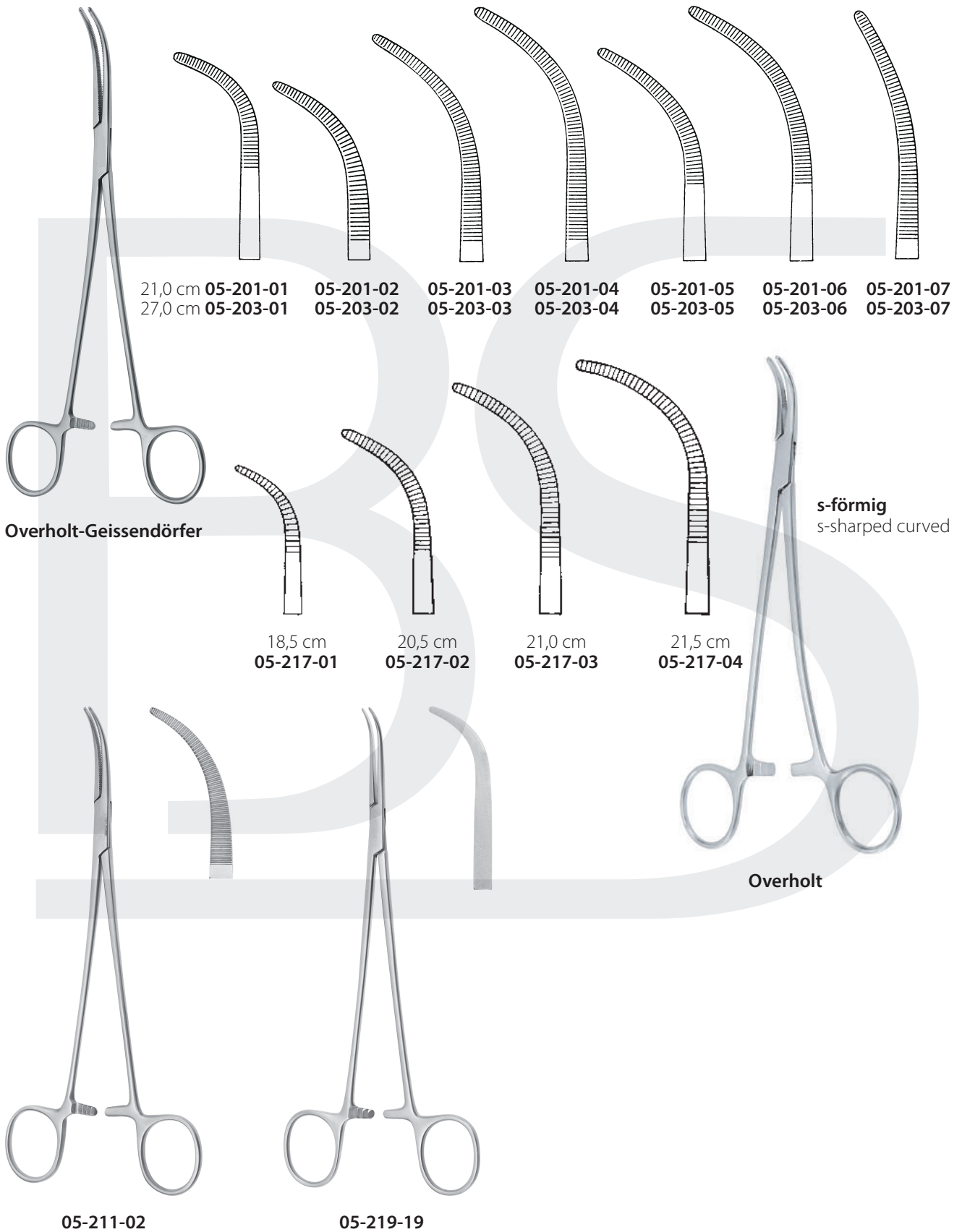

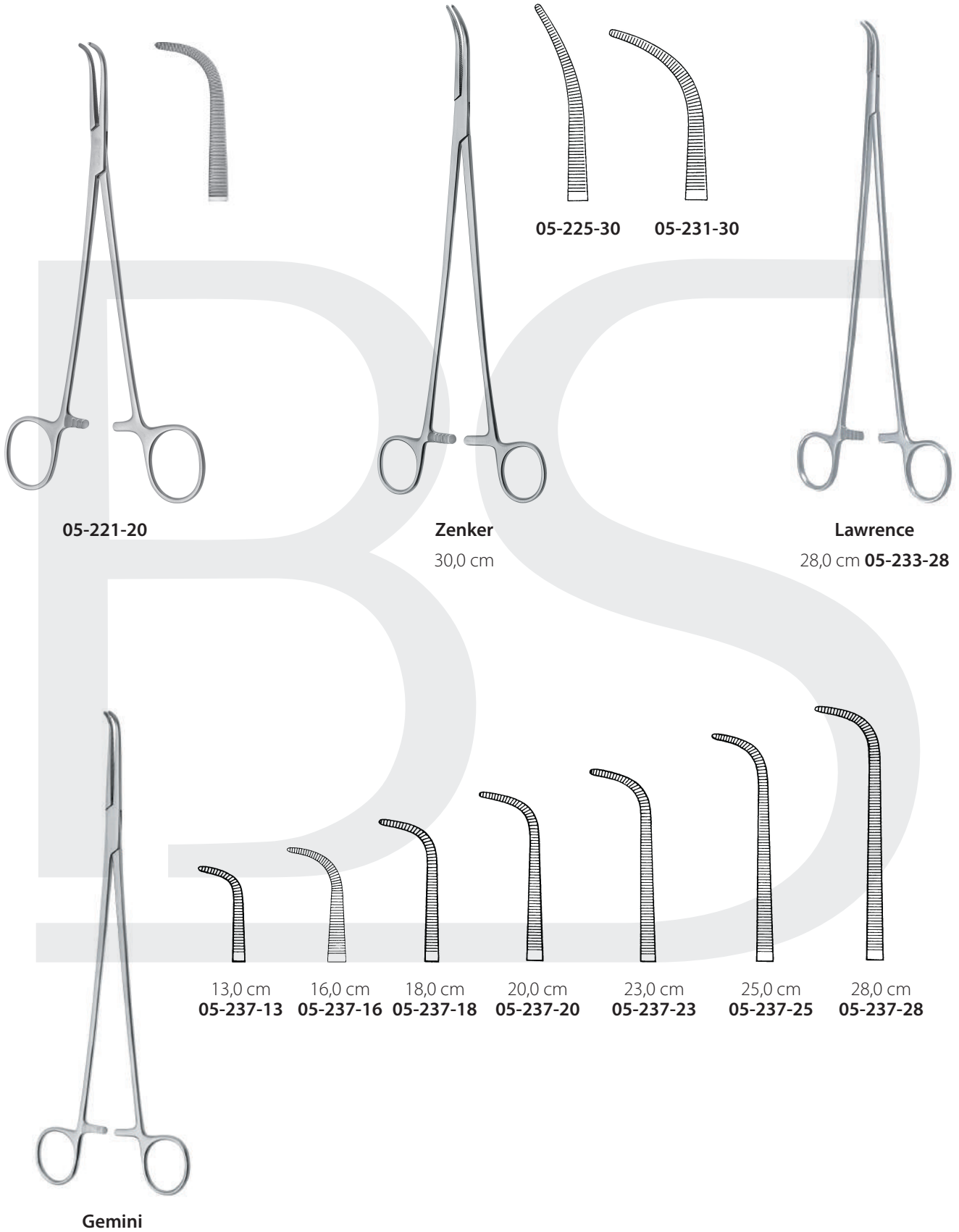



Mini-Gemini

18,0 cm
05-239-18

22,0 cm
05-239-22

25,0 cm
05-239-25

28,0 cm
05-239-28

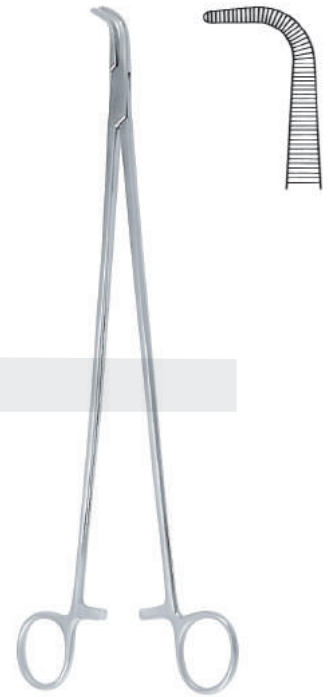

Meeker

18,0 cm 05-243-18
27,5 cm 05-243-28



Craford

18,0 cm 05-245-18
24,0 cm 05-245-24



Sarot

24,0 cm

05-248-24 05-249-24

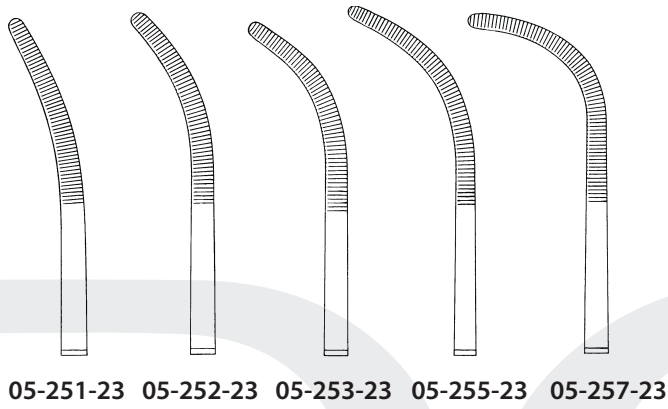

Rumel
23,0 cm



Mixer
22,0 cm 05-259-22
23,0 cm 05-259-23



Overholt-Mixer
21,0 cm 05-261-21



Mixer
15,5 cm 05-263-15
19,0 cm 05-263-19

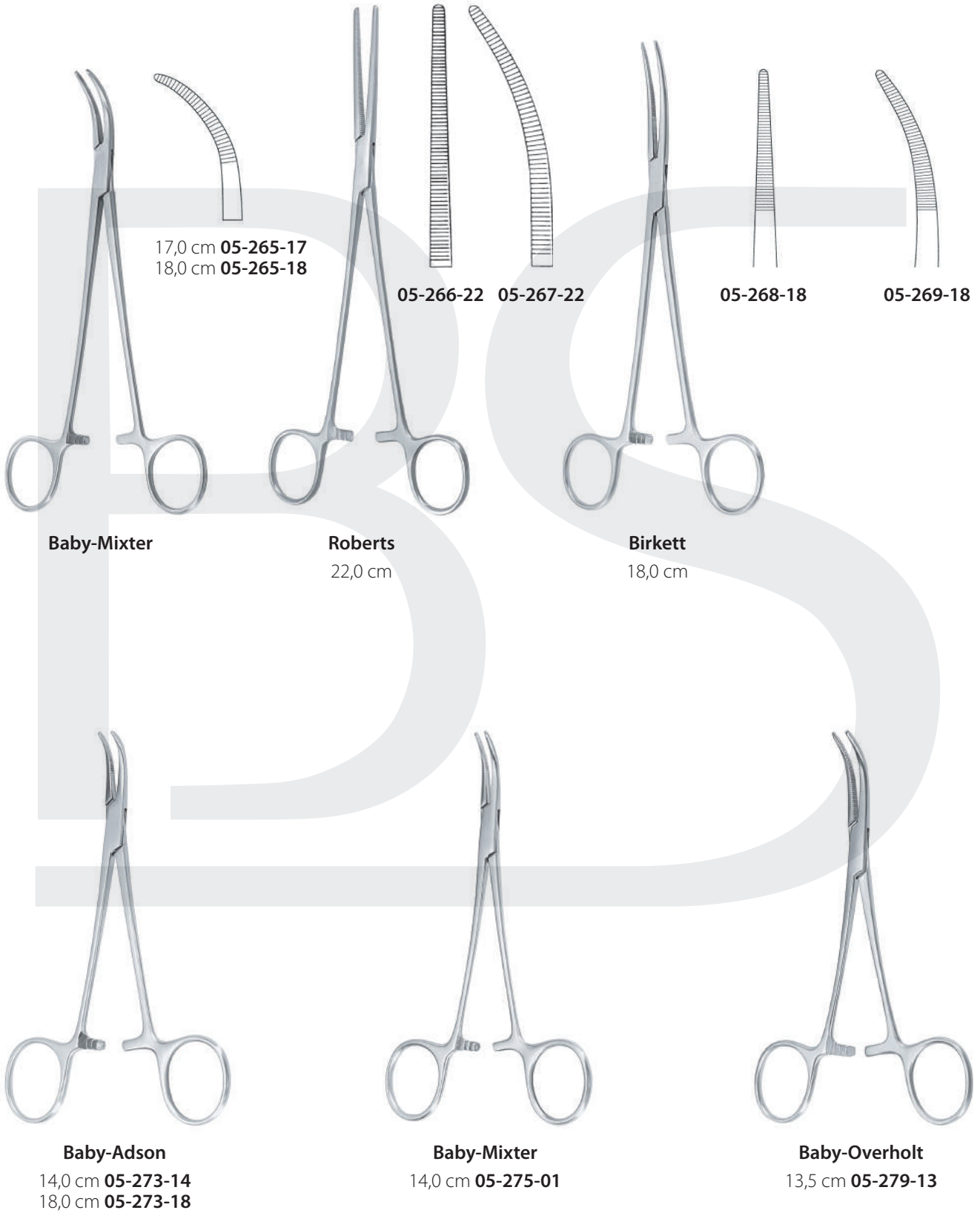

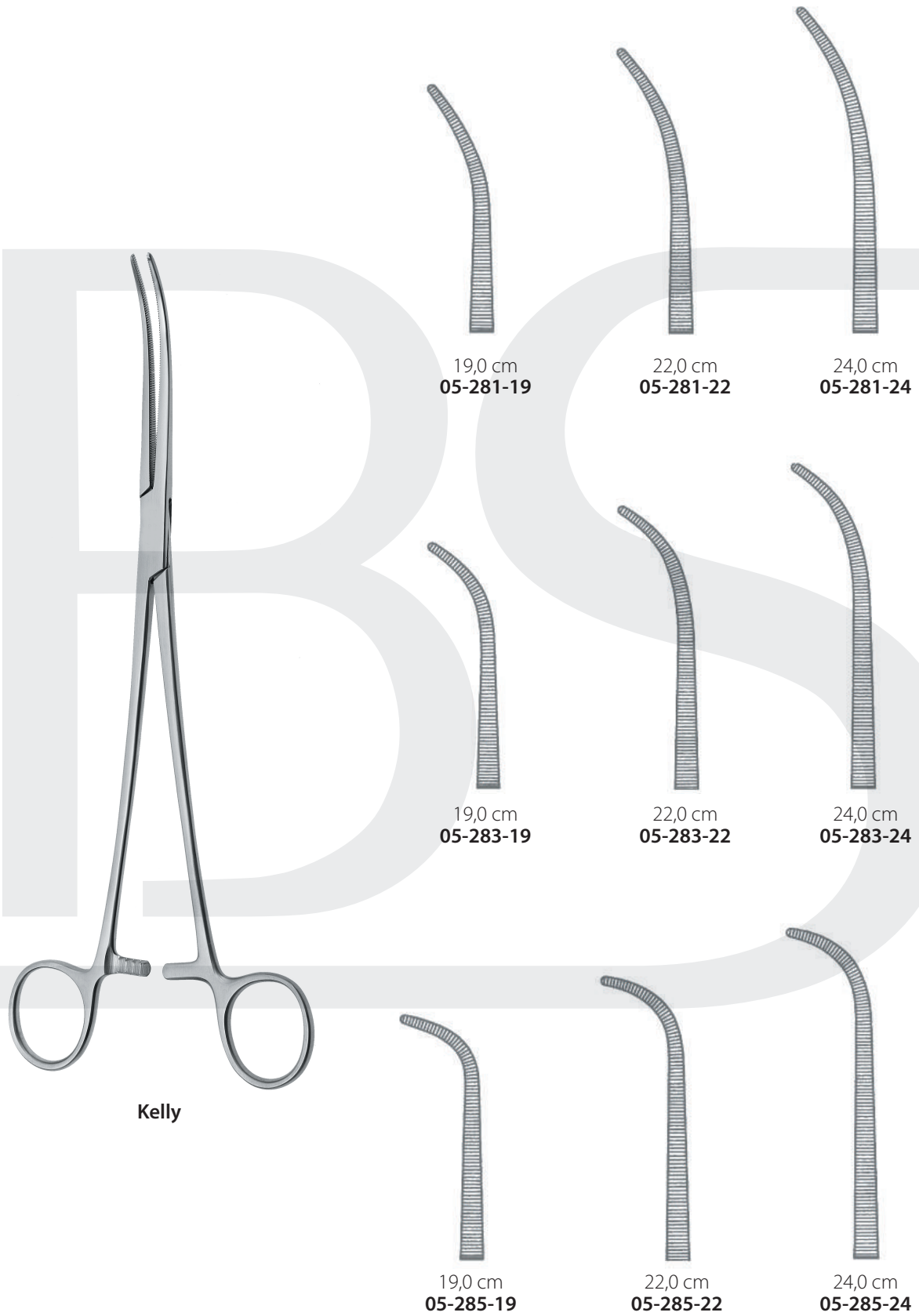

Kelly

Peritoneum- und Vaginalklemmen
Peritoneum and Vaginal Forceps



Wertheim
25,0 cm 05-305-25



leicht gebogen
slightly curved
22,0 cm
05-307-22

stärker gebogen
more curved
23,0 cm
05-307-23

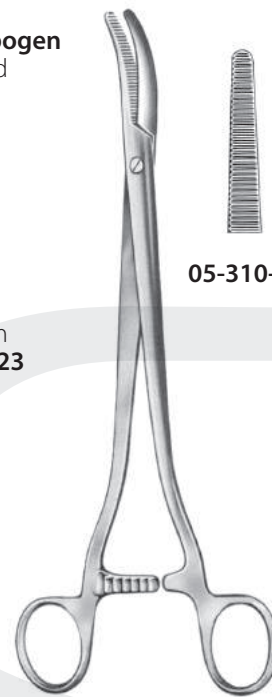

24,0 cm
Second-Landau

05-310-24 05-311-24

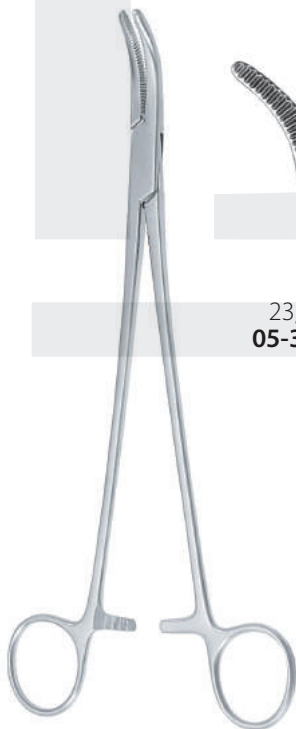

Moynihan



23,0 cm 24,0 cm
05-313-23 05-313-24

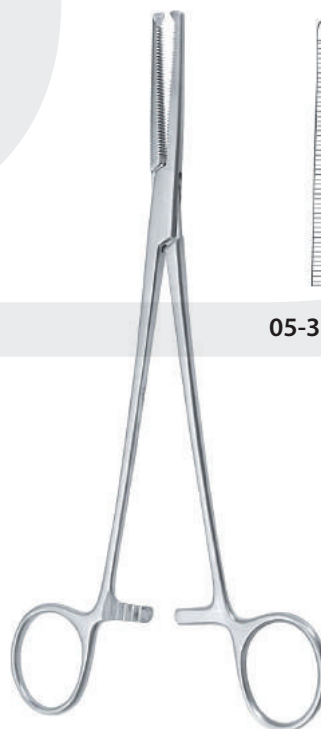

21,5 cm
Phaneuf

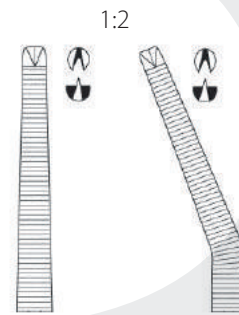

05-314-21 05-315-21



Heaney

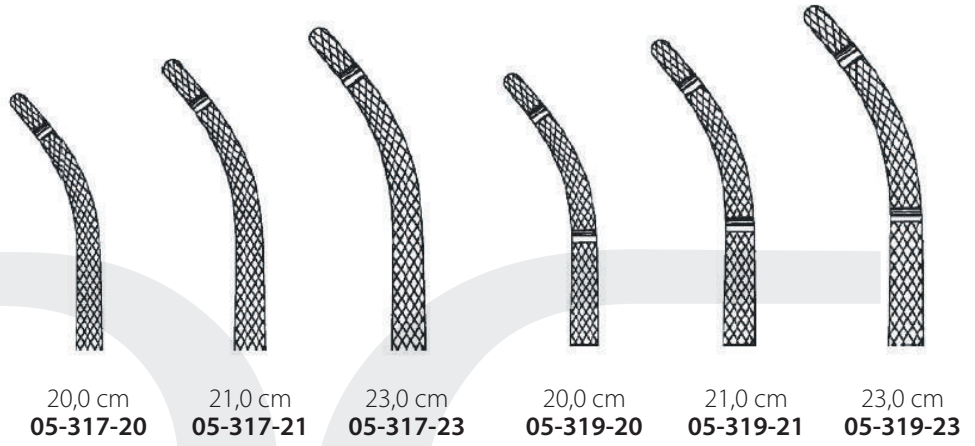

Rogers

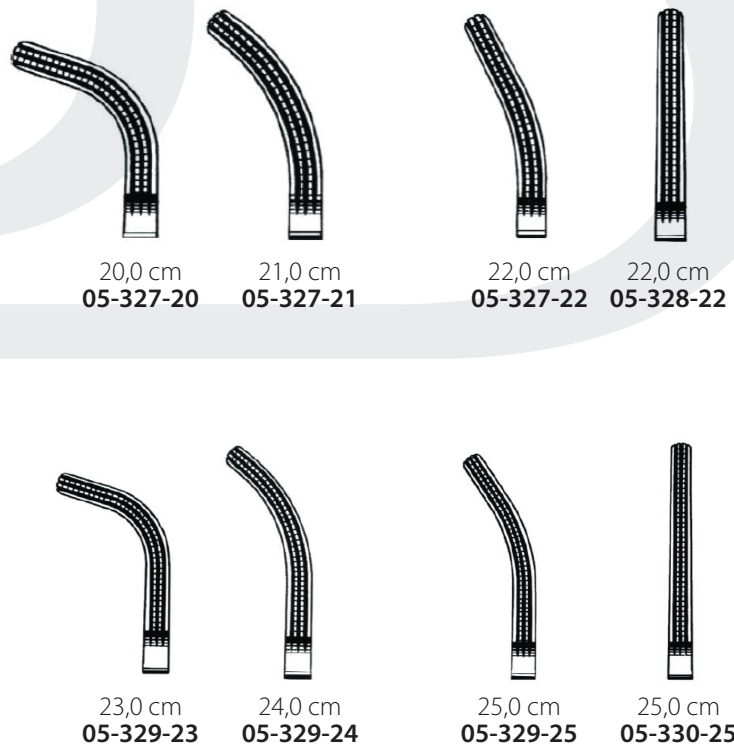

Peritoneumklemmen
Peritoneum Forceps



Wertheim - Cullen
21,5 cm **05-335-21**



Pratt
15,0 cm **05-338-15**



Mikulicz
20,5 cm **05-339-20**

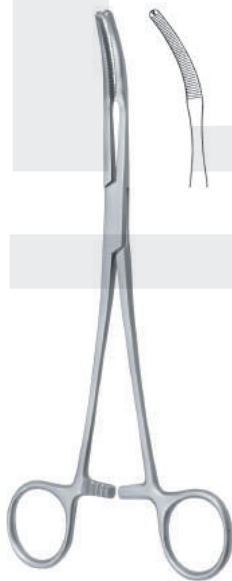

Mikulicz
20,0 cm **05-341-20**

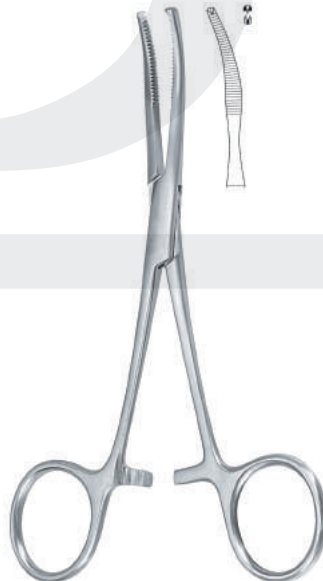

Baby-Mikulicz
14,0 cm **05-343-14**
18,0 cm **05-343-18**
20,0 cm **05-343-20**



20,0 cm
Faure

05-345-19 **05-345-20**



22,0 cm
05-355-22

Mixer

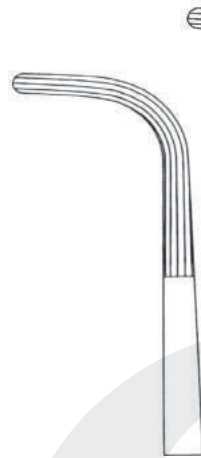

25,0 cm
05-355-25

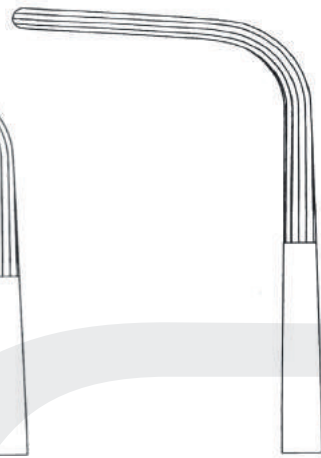

28,0 cm
05-355-28



Finochietto
24,0 cm **05-357-24**



Gray



22,0 cm **05-359-22**



23,0 cm **05-359-23**



19,0 cm 05-361-19
23,0 cm 05-361-23

Lahey



Johns-Hopkins
20,0 cm 05-363-20

Johns-Hopkins



Lower
18,0 cm 05-365-18

Lower



Mixter-O'Shaughnessy
15,5 cm 05-367-15
19,0 cm 05-367-19

Mixter-O'Shaughnessy



Desjardins
21,0 cm 05-369-21

Desjardins

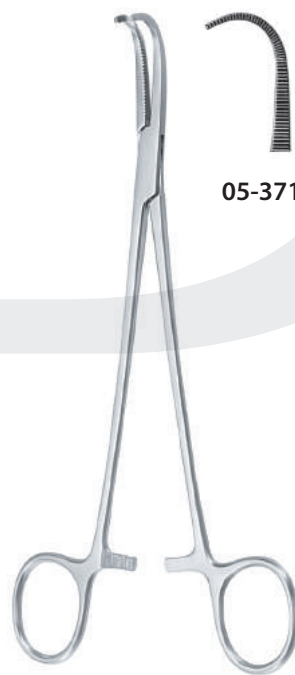

19,0 cm
Negus

19,0 cm

05-371-18 05-371-19



Guyon

20,0 cm
05-373-20



22,0 cm
05-373-22

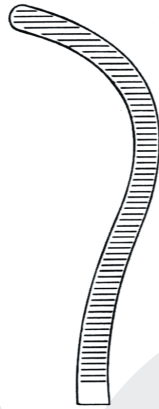

24,0 cm
05-373-24



Guyon

23,0 cm 05-375-23

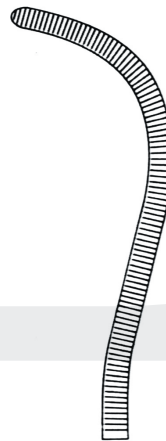

Nierenstielklemmen

Kidney Pedicle Forceps

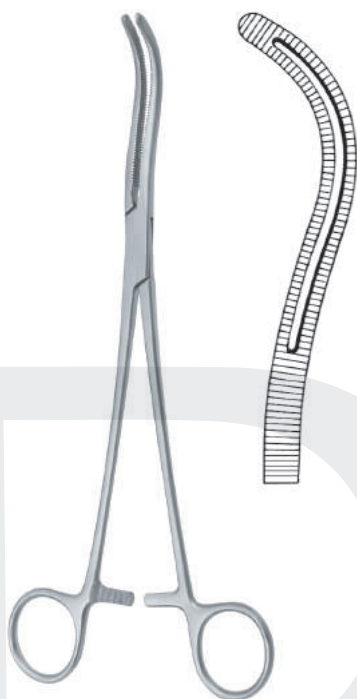

Stille
23,0 cm 05-377-23

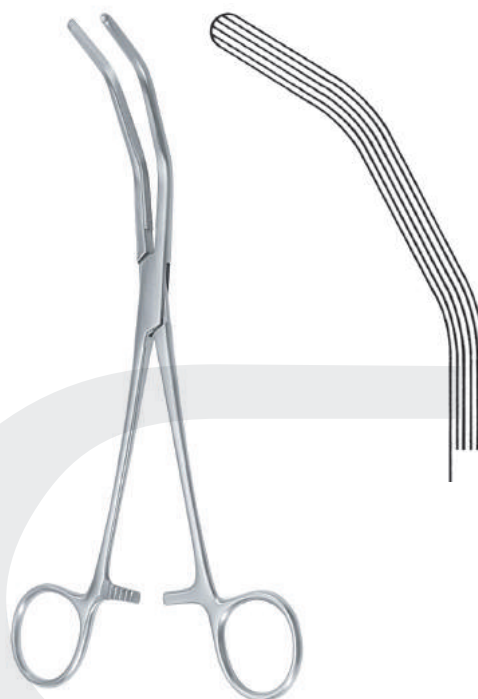

Herrick
23,0 cm 05-379-23

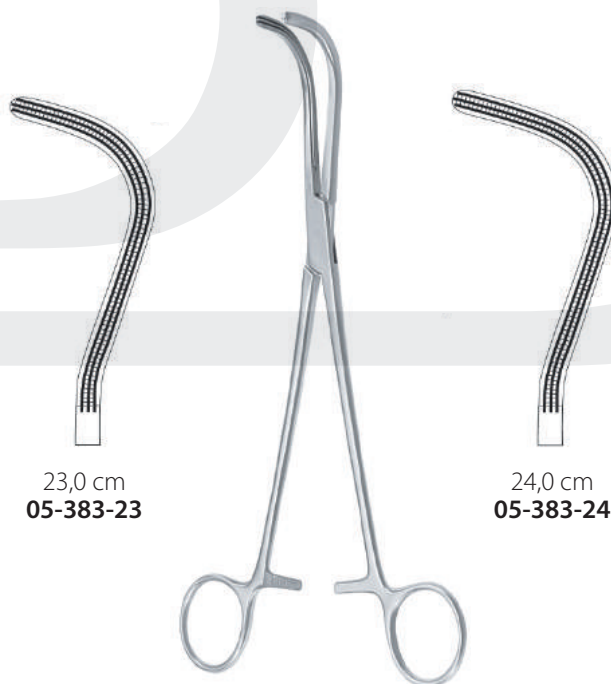

23,0 cm
05-383-23

24,0 cm
05-383-24

Guyon - Atrauma



Price - Thomas
22,0 cm **05-390-22**



Price - Thomas

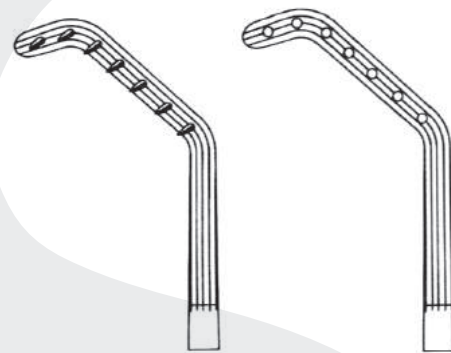

22,0 cm **05-391-01**

22,0 cm **05-391-02**

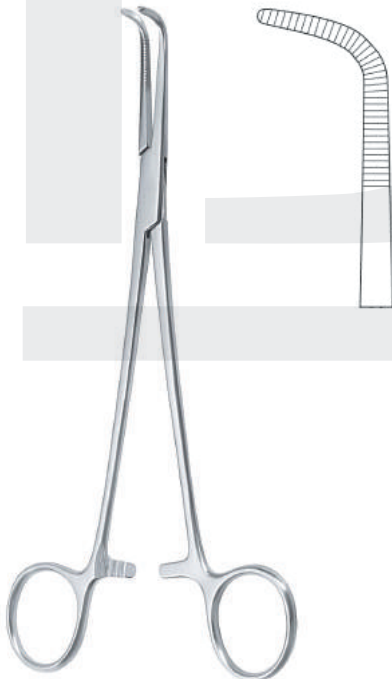

Kantrowitz
19,0 cm **05-393-19**
24,0 cm **05-393-24**
26,5 cm **05-393-26**

Atrauma Bulldogklemmen

Atrauma Bulldog Clamps



05-490-10
47 mm
10 mm



05-490-14
51 mm
14 mm



05-490-20
57 mm
20 mm



05-491-10
44 mm
10 mm



05-491-14
46 mm
14 mm

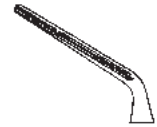

05-491-20
49 mm
20 mm

Schließdruck/closing pressure 180g

Gesamtlänge/Total length
Maullänge/Length of jaw



Gesamtlänge/Total length
Maullänge/Length of jaw

05-492-50
48 mm
20 mm

05-493-48
48 mm
20 mm

Gesamtlänge Total length	Maullänge Length of jaw
80 mm	20 mm
90 mm	30 mm
105 mm	45 mm
125 mm	68 mm

05-494-08
05-494-09
05-494-10
05-494-12

05-495-08
05-495-09
05-495-10
05-495-11

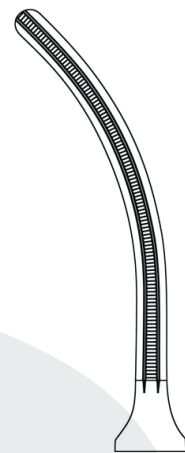
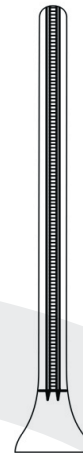

80°

Glover Gesamtlänge Total length	Maullänge Length of jaw
60 mm	28 mm
70 mm	33 mm
95 mm	50 mm
110 mm	69 mm

05-496-06
05-496-07
05-496-10
05-496-12

05-497-06
05-497-07
05-497-09
05-497-11

05-497-43
43 mm



05-498-08
50 mm
8 mm

05-498-12
50 mm
12 mm

05-498-20
60 mm
20 mm

05-499-08
50 mm
8 mm

05-499-12
50 mm
12 mm

05-499-20
60 mm
20 mm

Schließdruck/closing pressure 80g
Diethrich
Gesamtlänge/Total length
Maullänge/Length of jaw



05-500-38
38 mm

05-500-48
51 mm

05-502-58
60 mm

05-501-38
38 mm

05-501-48
51 mm

05-503-58
60 mm

Dieffenbach
Gesamtlänge/Total length



38 mm **05-505-38**
48 mm **05-505-48**
56 mm **05-505-56**
63 mm **05-505-63**
70 mm **05-505-70**
80 mm **05-505-80**
91 mm **05-505-91**

Johns-Hopkins



Anlegezange für Bulldogklemmen
Setting Forceps for Bulldog Clamps
24, cm **05-507-24**

Titan/Titanium V = Vena
A = Ateria

V = A =	30,0 mm 05-512-30 05-516-30	35,0 mm 05-512-35 05-516-35	40,0 mm 05-512-40 05-516-40	50,0 mm 05-512-50 05-516-50
V = A =	30,0 mm 05-513-30 05-517-30	35,0 mm 05-513-35 05-517-35	40,0 mm 05-513-40 05-517-40	50,0 mm 05-513-50 05-517-50
V = A =	30,0 mm 05-515-30 05-519-30	35,0 mm 05-515-35 05-519-35	40,0 mm 05-515-40 05-519-40	50,0 mm 05-515-50 05-519-50



Satinsky
70 mm 05-525-07

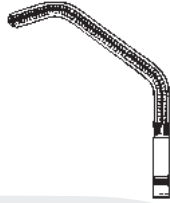

Carotis
90 mm 05-527-09

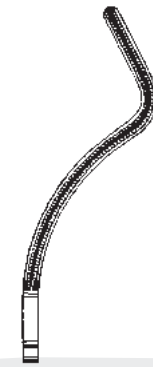

Satinsky
100 mm 05-529-10



Carotis
50 mm 05-531-05



Santulli
70 mm 05-533-07

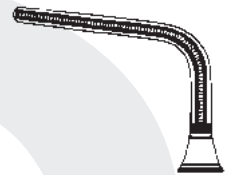

Gregory-Soft
90 mm 05-535-09

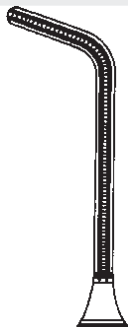

110 mm 05-535-11

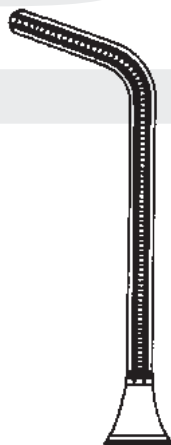

links
left



110 mm 05-537-01



Gregory-Soft
110 mm 05-537-02

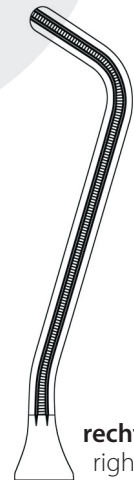

rechts
right

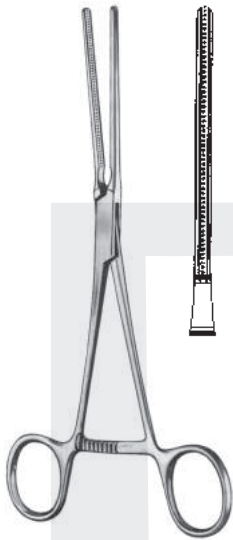

Castaneda
12,0 cm 05-540-13



12,0 cm, 30°
05-541-01



12,0 cm, 45°
05-541-02



11,0 cm, 90°
05-541-03



Castaneda
15,0 cm



Fig. 1
05-543-01



Fig. 2
05-543-02



Fig. 3
05-543-03

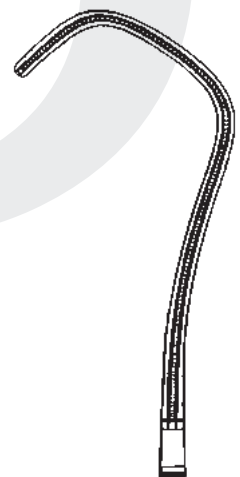
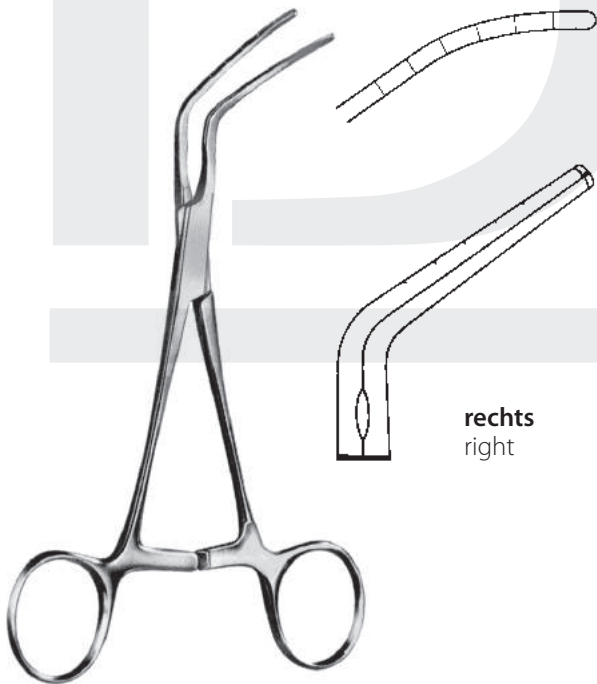

Fig. 4
05-543-04



Subramanian-Miniature
15,5 cm 05-545-15



rechts
right

Subramanian
16,0 cm 05-547-16

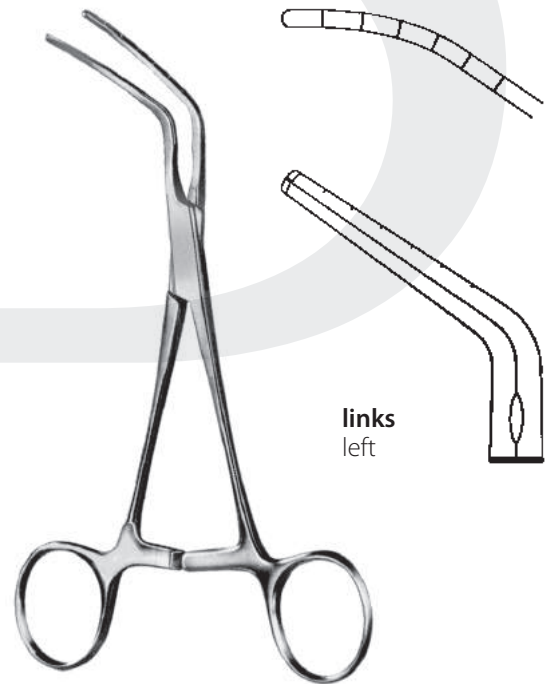

links
left

Subramanian
16,0 cm 05-549-16



De Bakey



12,0 cm
05-554-12

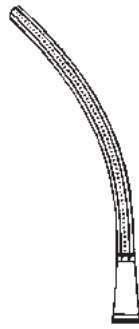

11,0 cm
05-555-11



10,0 cm
05-557-10



De Bakey



s-gebogen
s-curved
12,0 cm
05-559-12

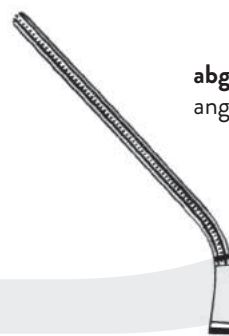

abgewinkelt
angled
13,0 cm
05-561-13

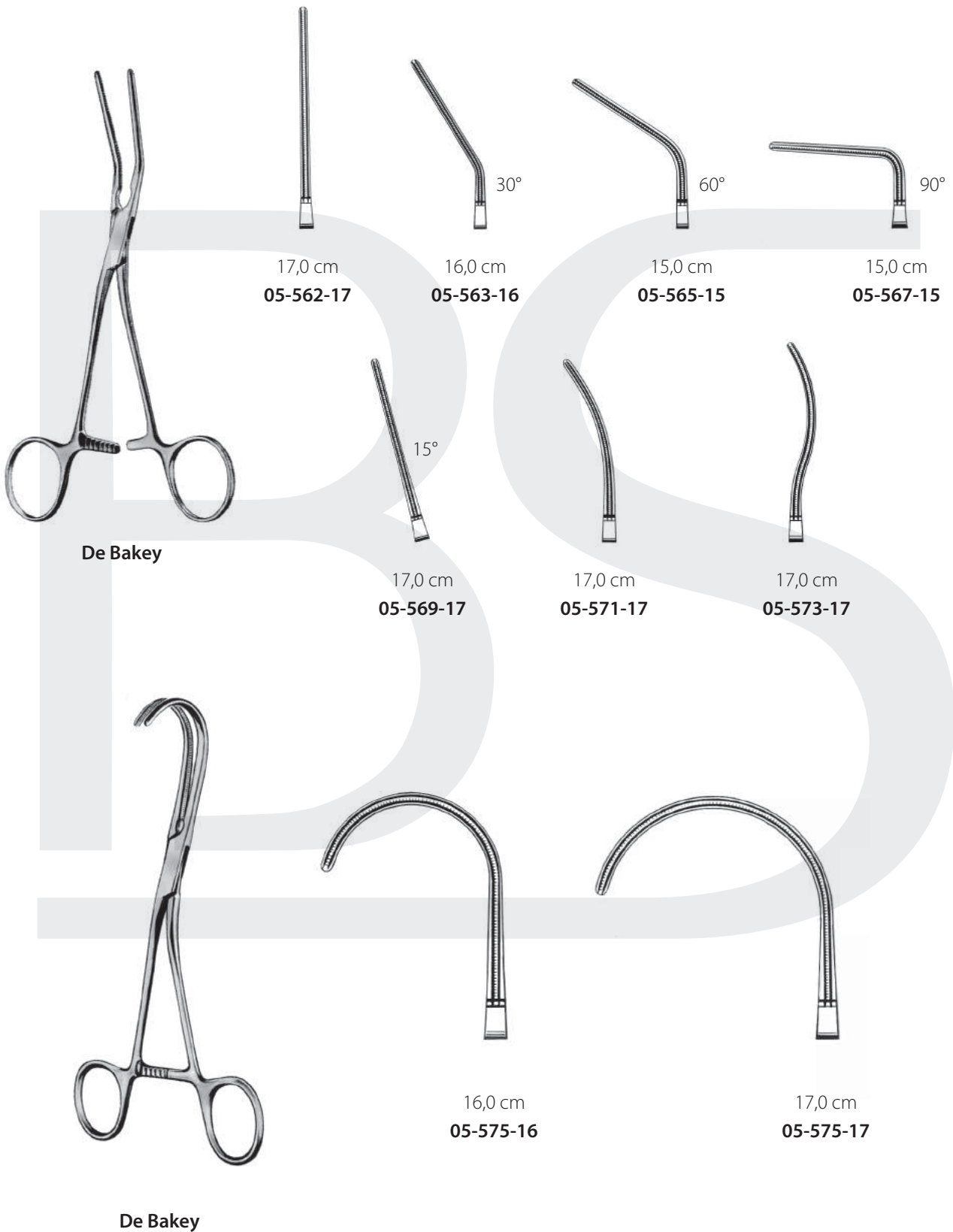



De Bakey

Beck

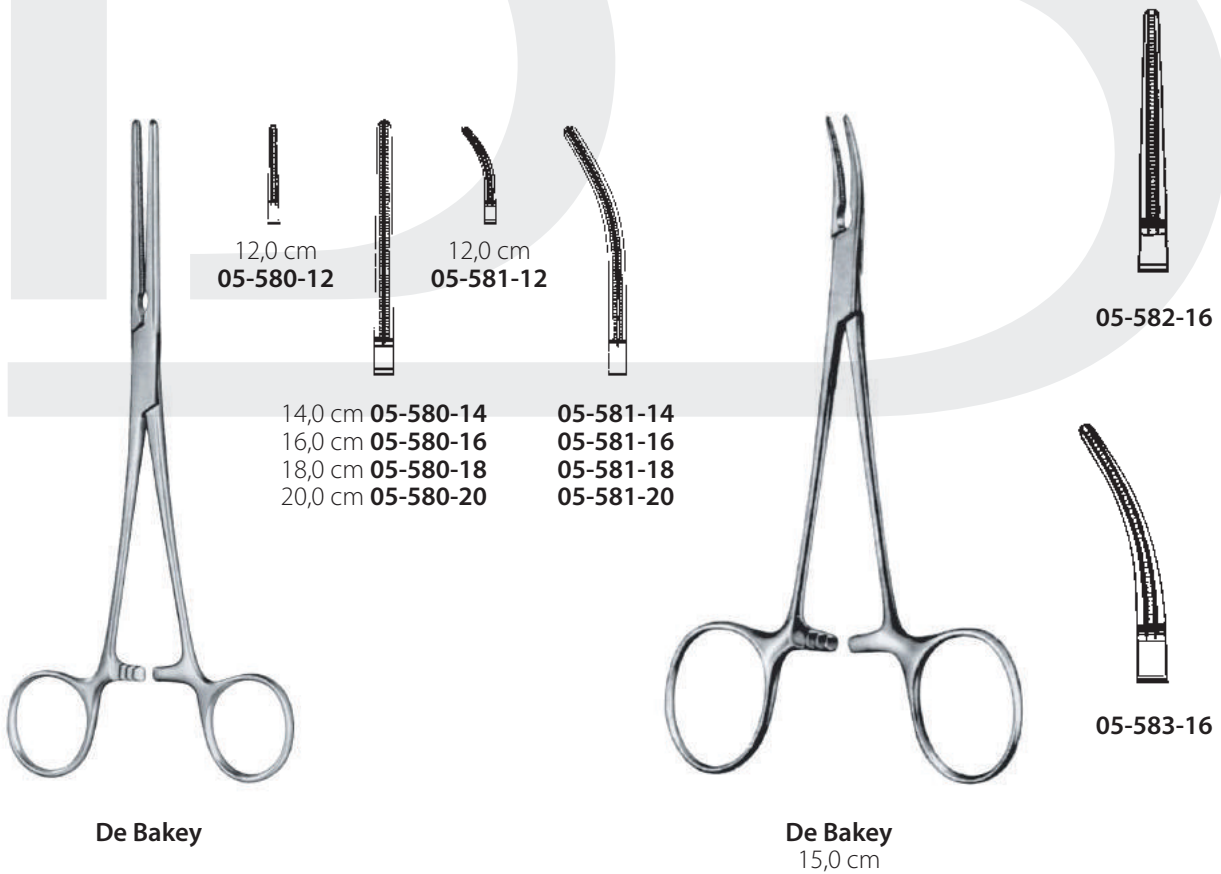

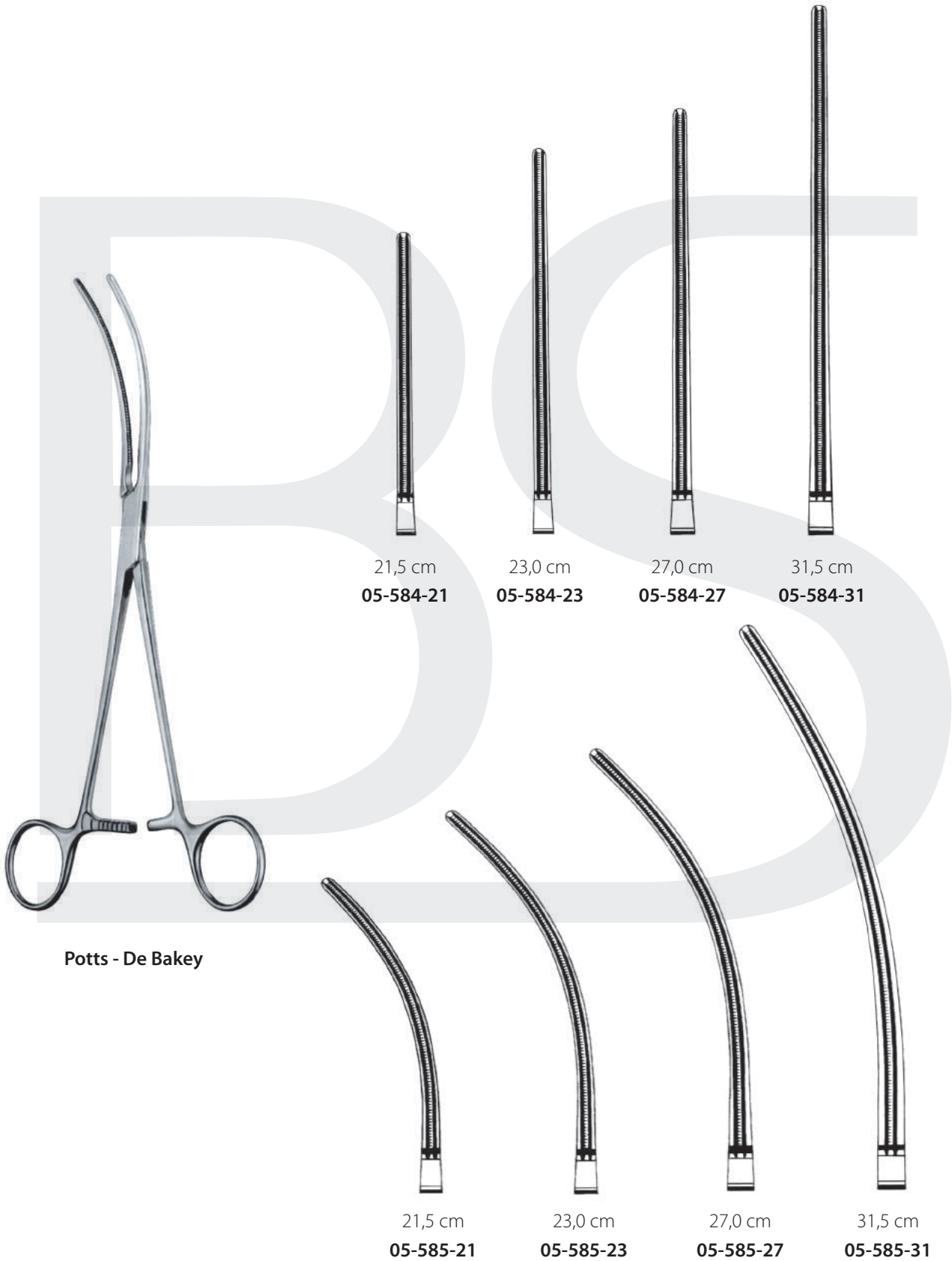

Potts - De Bakey

Atraumaklemmen
Atrauma Forceps



De Bakey



26,0 cm
05-587-26



27,0 cm
05-587-27



31,0 cm
05-587-31



33,0 cm
05-587-33

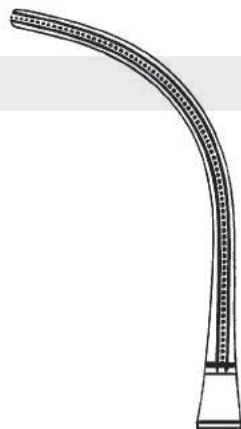

23,0 cm
05-589-23



24,0 cm
05-589-24



25,0 cm
05-589-25

De Bakey-Bahnson



De Bakey

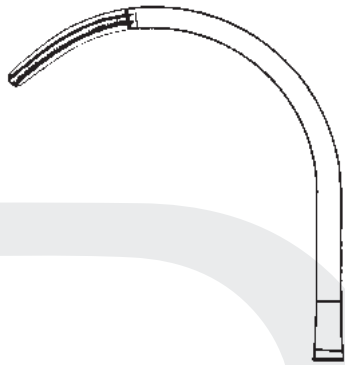

26,5 cm
05-591-25

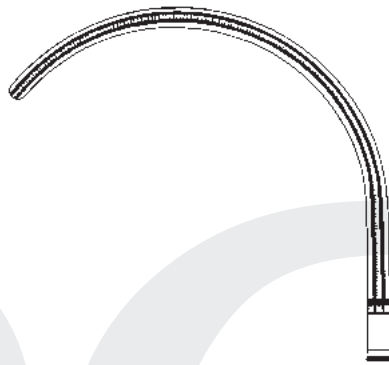

27,0 cm
05-591-26

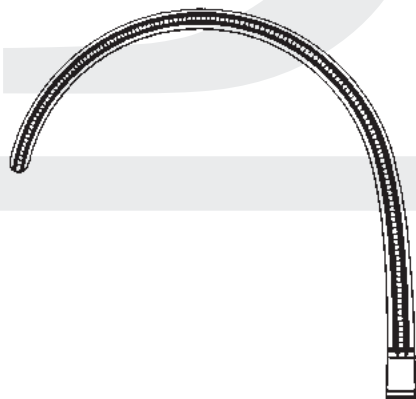

links abgebogen
left curved

24,0 cm **05-593-01**

rechts abgebogen
right curved

24,0 cm **05-593-02**



Weber



De Bakey
28,0 cm 05-595-28



De Bakey
30,0 cm 05-595-30

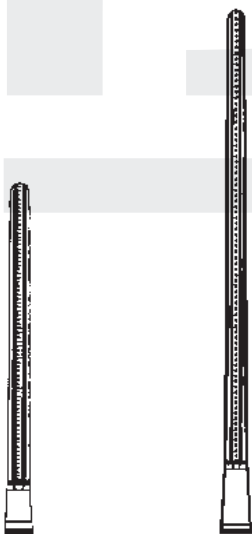

15,0 cm
05-596-15

18,5 cm
05-596-18



Bainbridge

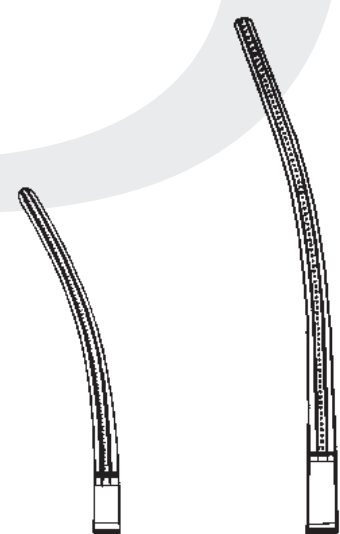

15,0 cm
05-597-15

18,5 cm
05-597-18



De Bakey
20,0 cm 05-599-20



Glover

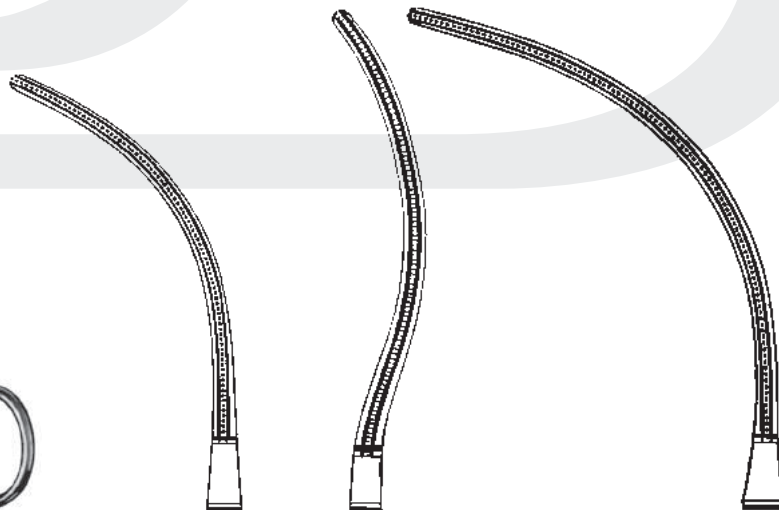

22,0 cm
05-601-22

22,5 cm
05-601-23

24,5 cm
05-601-24

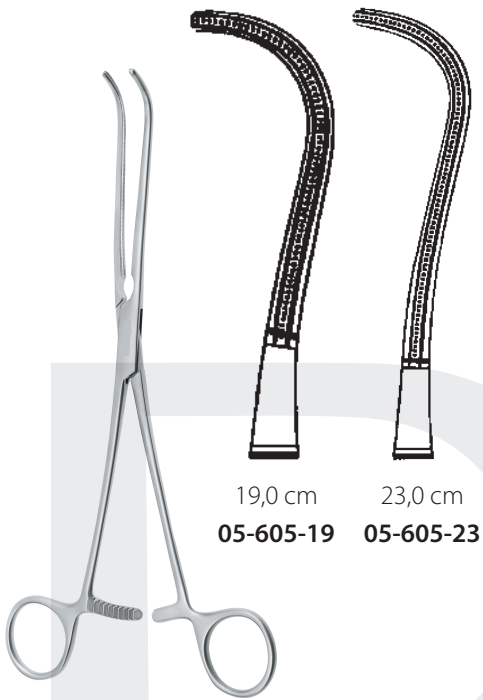

19,0 cm
05-605-19 23,0 cm
05-605-23

De Bakey

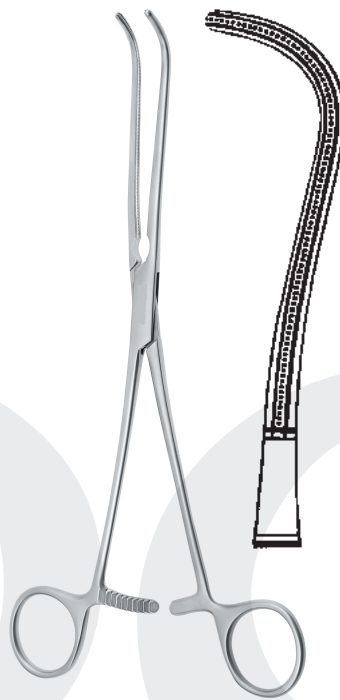

De Bakey
24,0 cm **05-605-24**



De Bakey
16,0 cm **05-607-16**



De Bakey

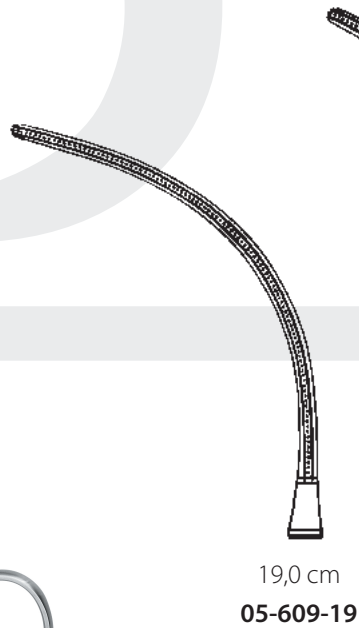

19,0 cm
05-609-19

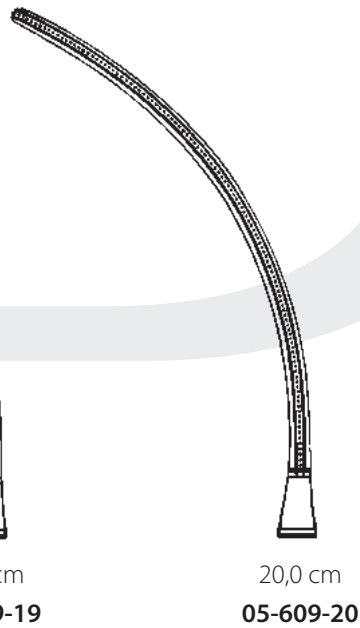

20,0 cm
05-609-20



Leland - Jones

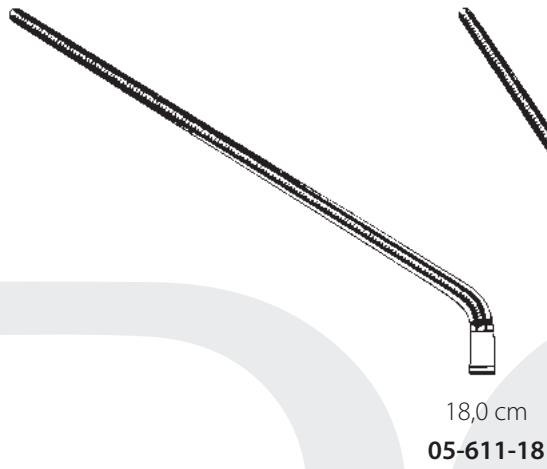

18,0 cm
05-611-18

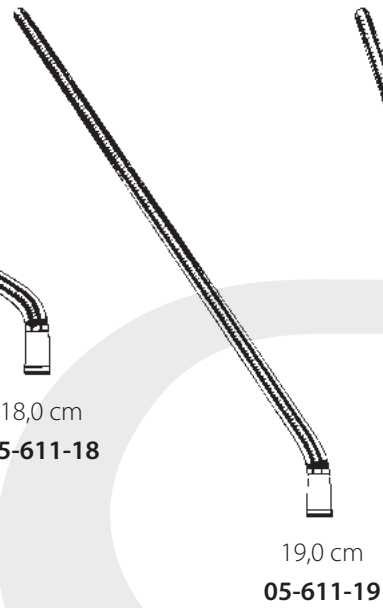

19,0 cm
05-611-19

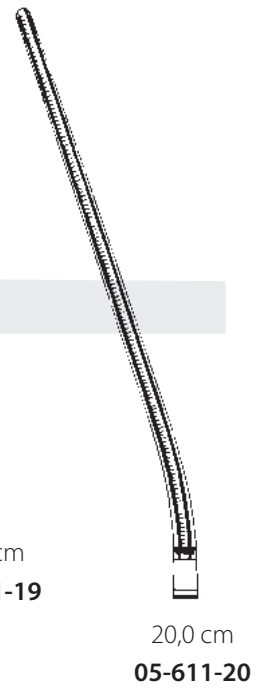

20,0 cm
05-611-20



21,0 cm
05-612-21



22,0 cm
05-612-22



24,0 cm
05-612-24



De Bakey



De Bakey



21,0 cm
05-613-21



22,0 cm
05-613-22

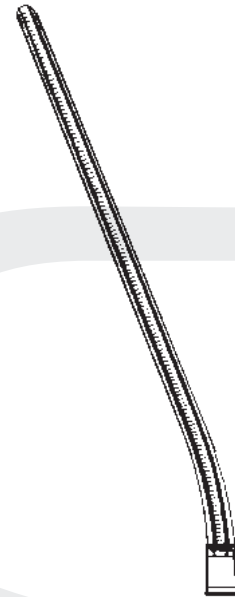

24,0 cm
05-613-24



21,0 cm
05-615-21



22,0 cm
05-615-22



De Bakey



De Bakey

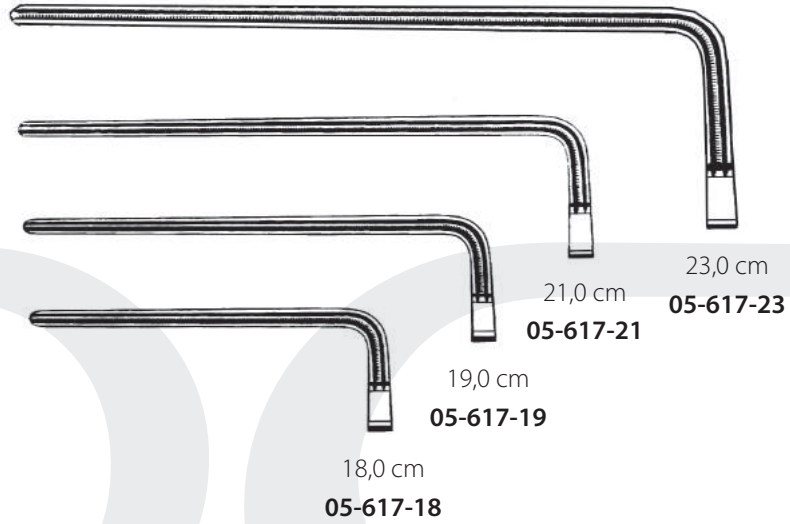

18,0 cm
05-617-18



De Bakey

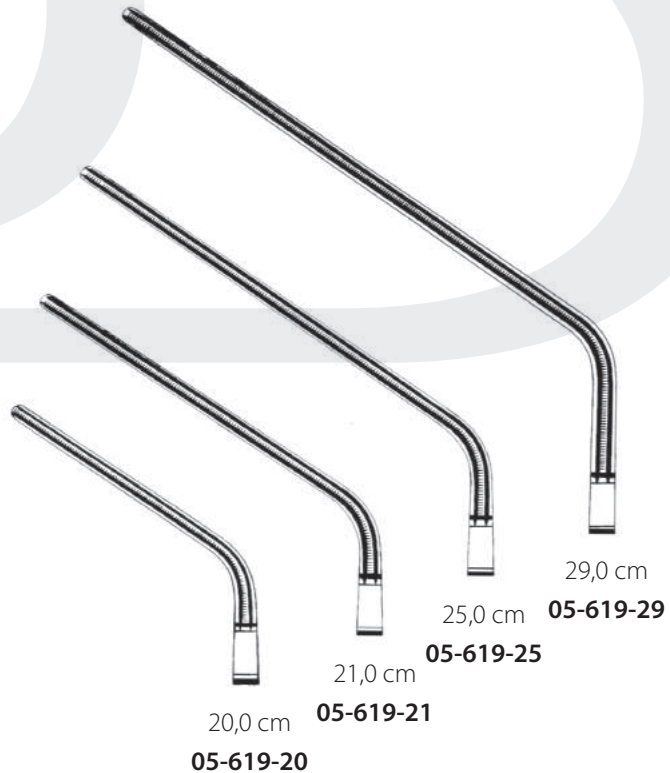

20,0 cm
05-619-20



Lees



23,0 cm
05-621-23



25,0 cm
05-621-25



Lees
25,0 cm 05-623-25

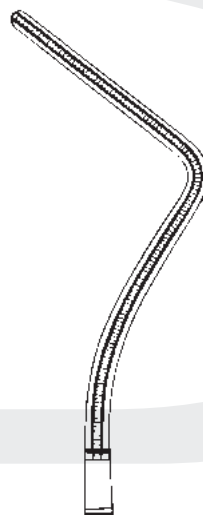



Morris-De Bakey



18,0 cm
05-625-01

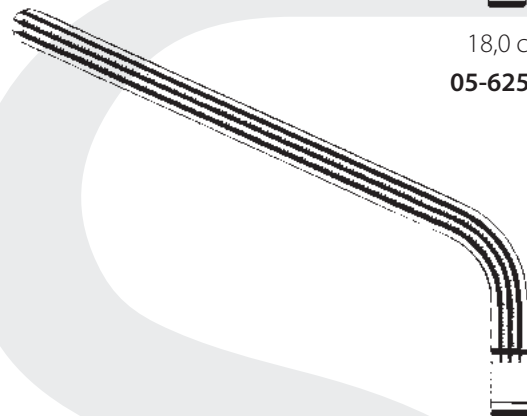

20,0 cm
05-625-03



23,0 cm
05-625-04

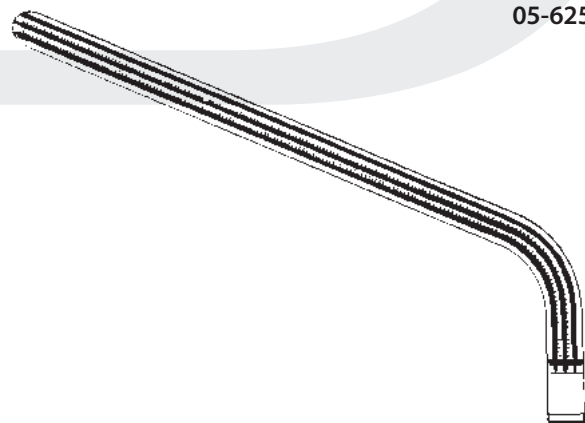

24,0 cm
05-625-05



De Bakey
27,0 cm **05-627-27**

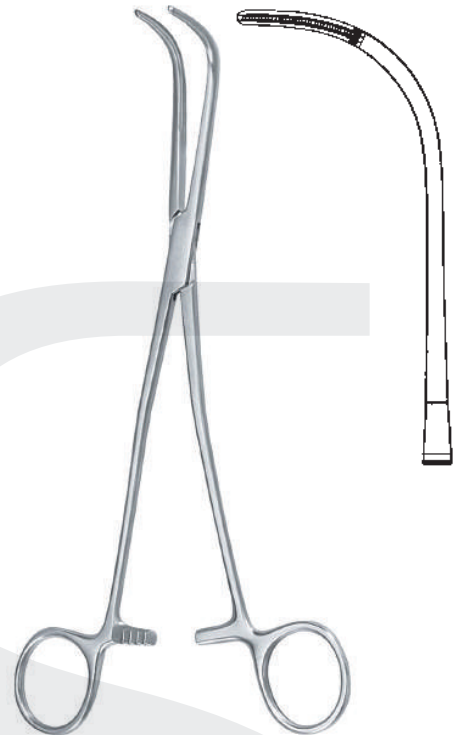

De Bakey
24,0 cm **05-629-24**



De Bakey
24,0 cm **05-631-24**



Gregory

14,0 cm
05-633-14

16,0 cm
05-633-16

18,0 cm
05-633-18



Javid

17,5 cm **05-635-18**

19,0 cm **05-635-19**

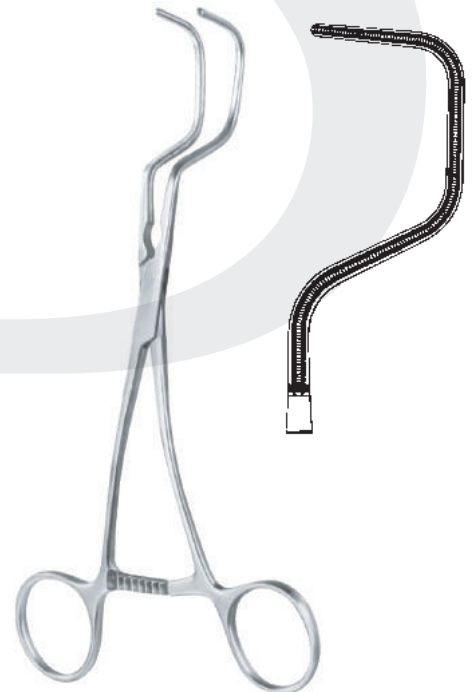

Dale

18,0 cm **05-639-18**

Atraumaklemmen
Atrauma Forceps



Dale

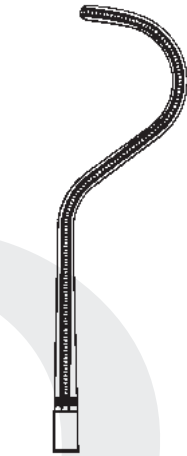

17,0 cm
05-641-17



18,0 cm
05-641-18

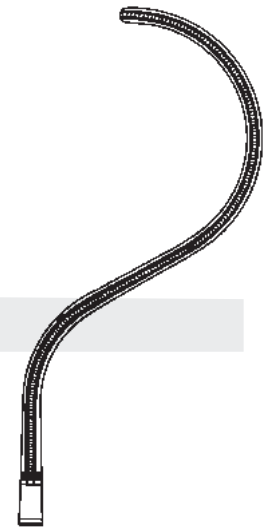

19,0 cm
05-641-19

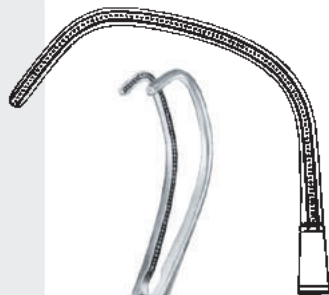

21,0 cm
05-643-21

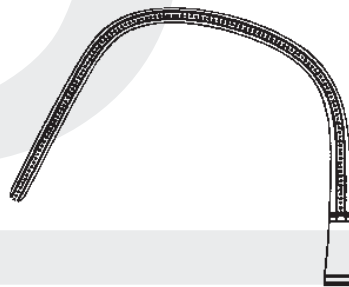

22,0 cm
05-643-22



Lambert-Kay

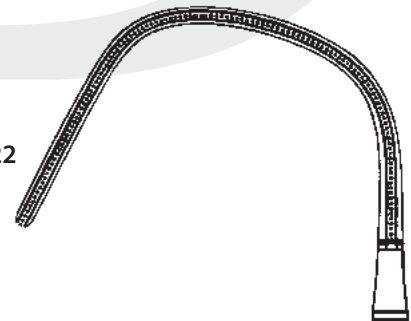

25,0 cm
05-643-25



17,0 cm **05-645-17**

De Bakey



20,0 cm **05-645-20**

Cooley-De Bakey



Satinsky

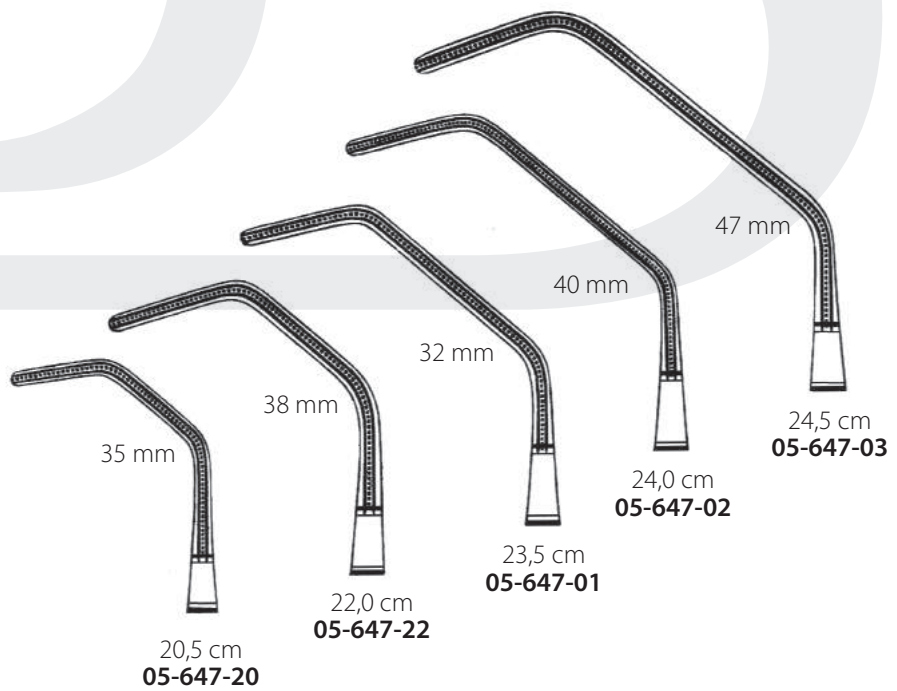

35 mm

20,5 cm
05-647-20

38 mm

22,0 cm
05-647-22

32 mm

23,5 cm
05-647-01

40 mm

24,0 cm
05-647-02

47 mm

24,5 cm
05-647-03



Satinsky

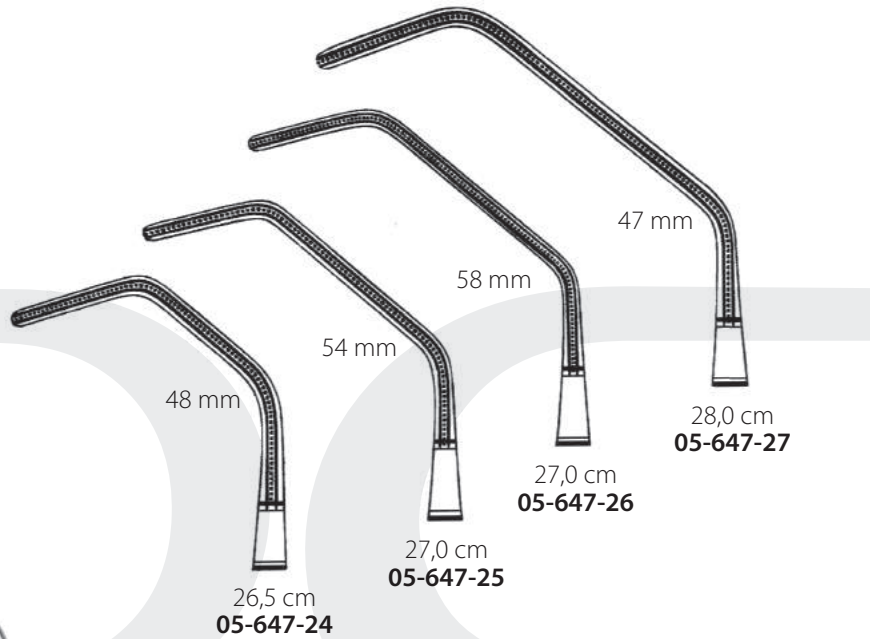

De Bakey



Ochsner
23,5 cm **05-649-23**



Diethrich
21,5 cm **05-651-21**

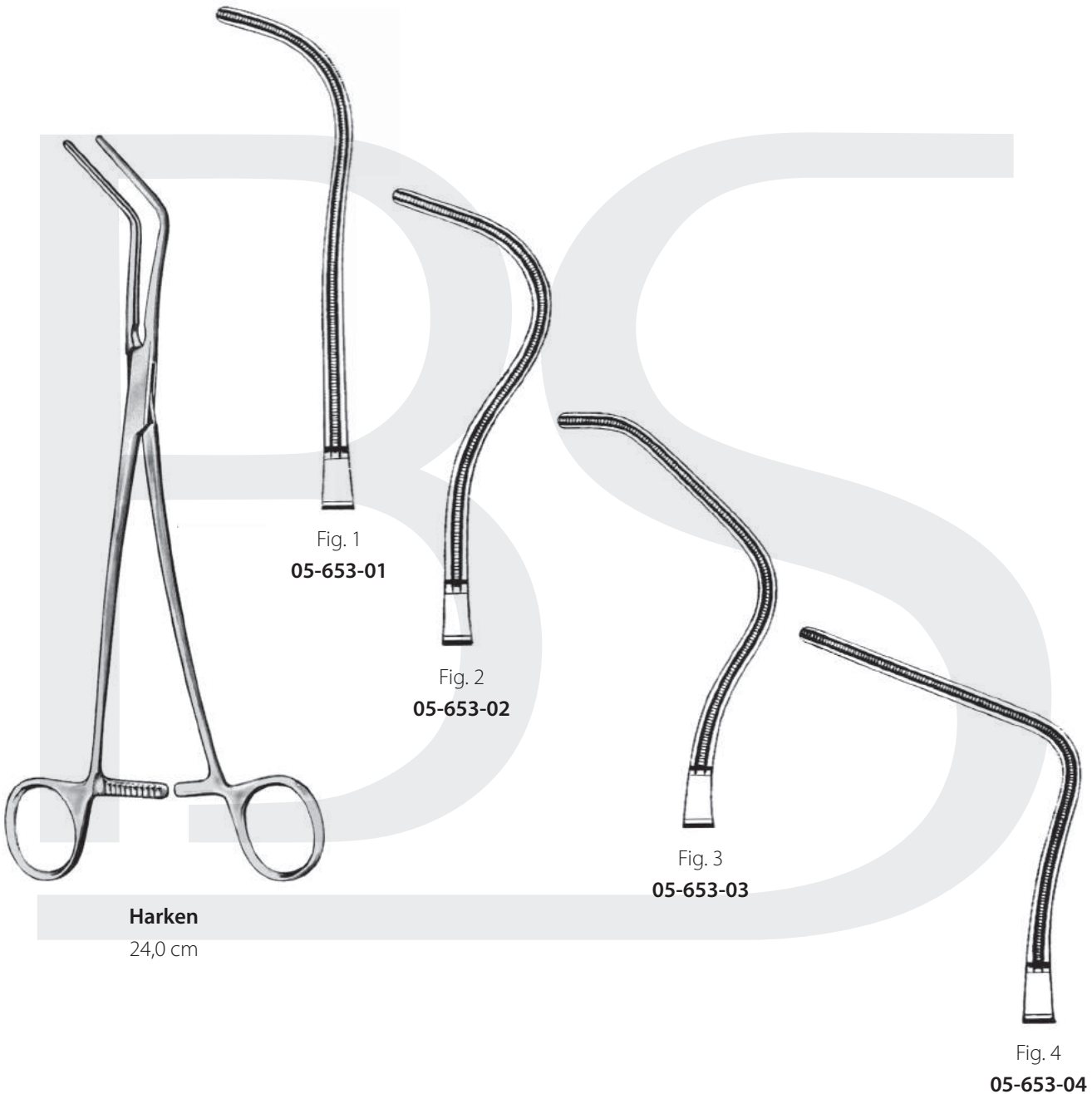

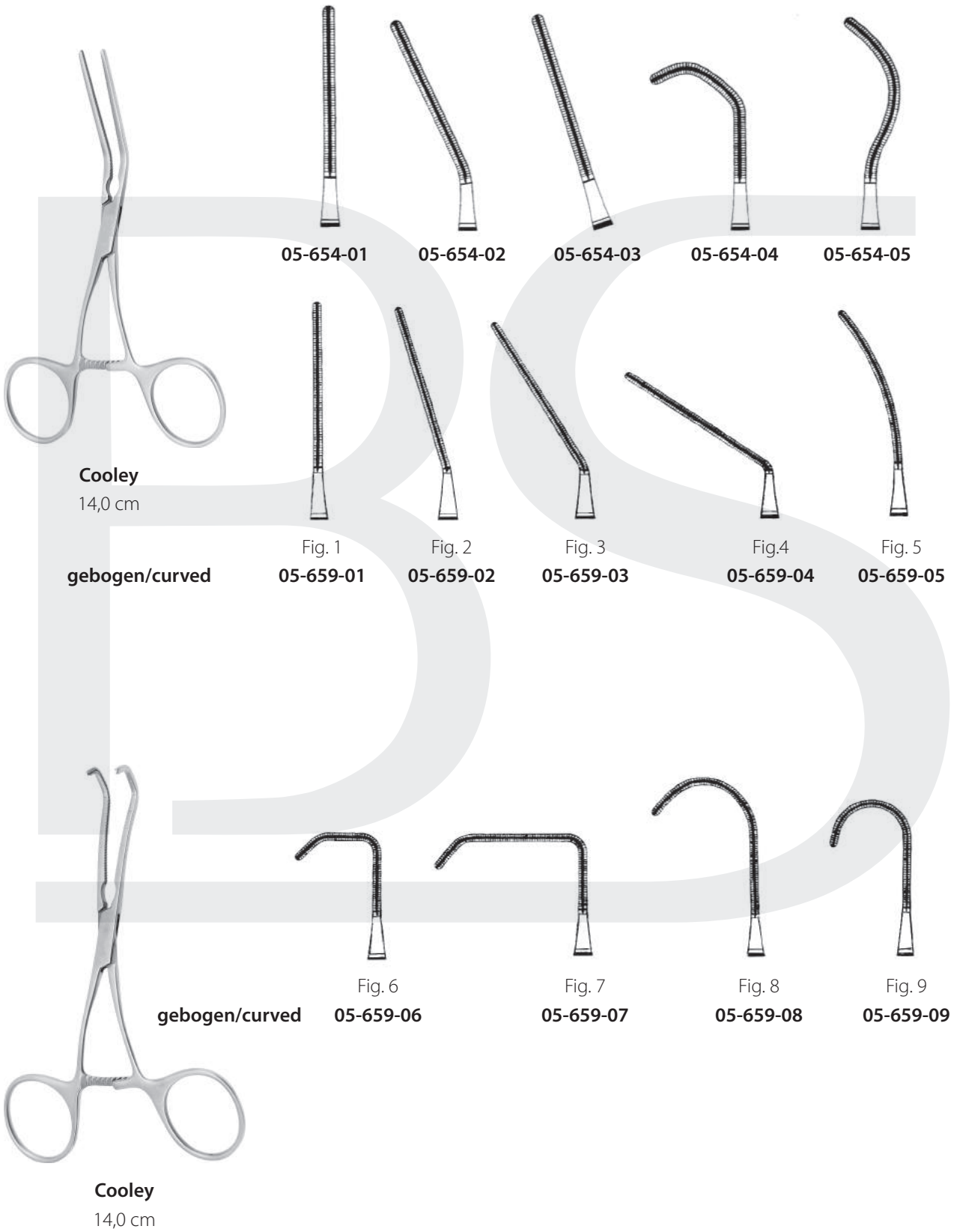

Cooley
14,0 cm

gebogen/curved

gebogen/curved

Cooley
14,0 cm

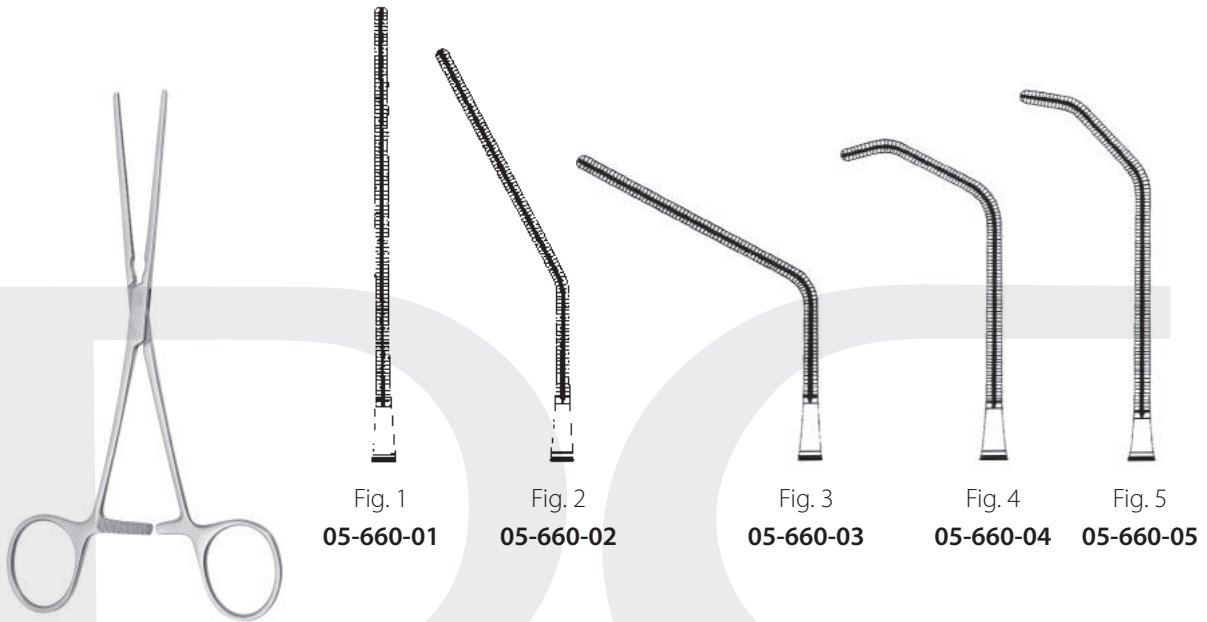

Cooley
16,0 cm

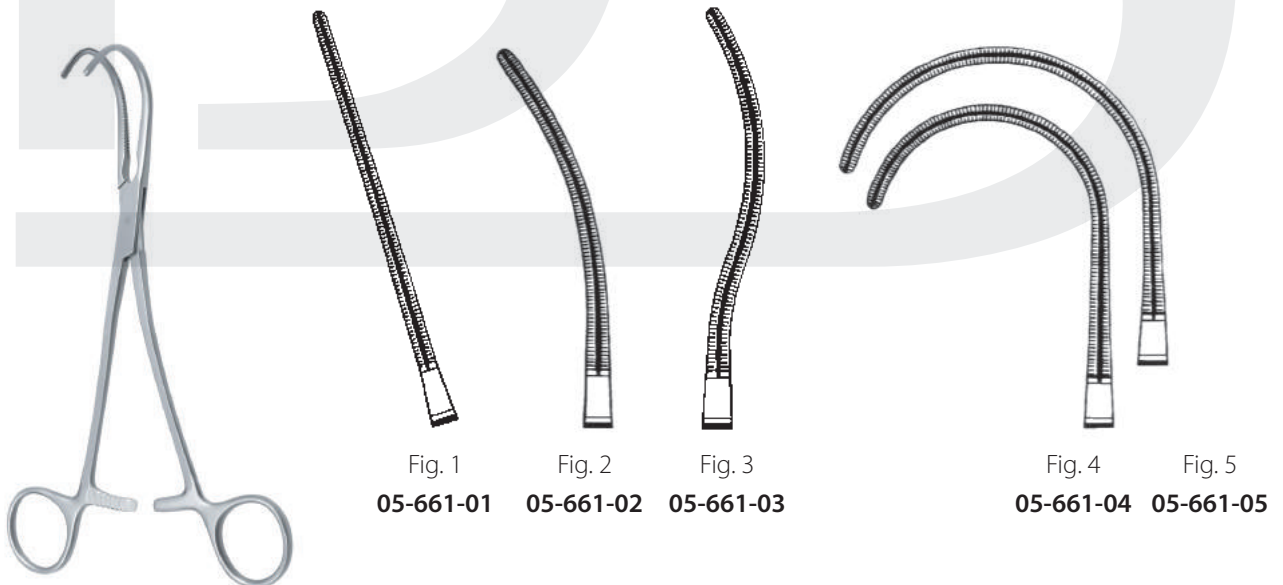

Cooley
17,0 cm

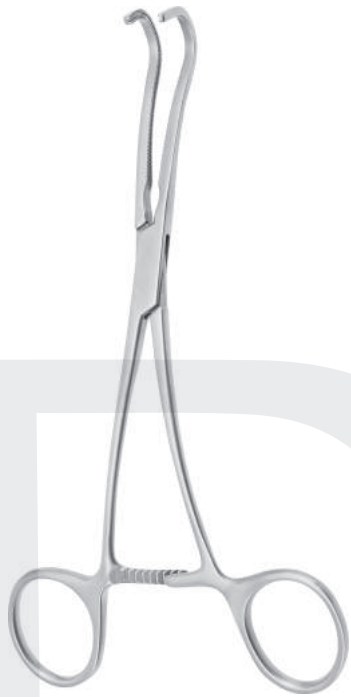

Cooley-Derra
17,0 cm



05-663-16



05-663-17



05-663-18



Cooley - Beck
17,0 cm 05-665-17



Cooley
17,0 cm 05-667-17



Cooley
16,0 cm 05-669-16
17,5 cm 05-669-17

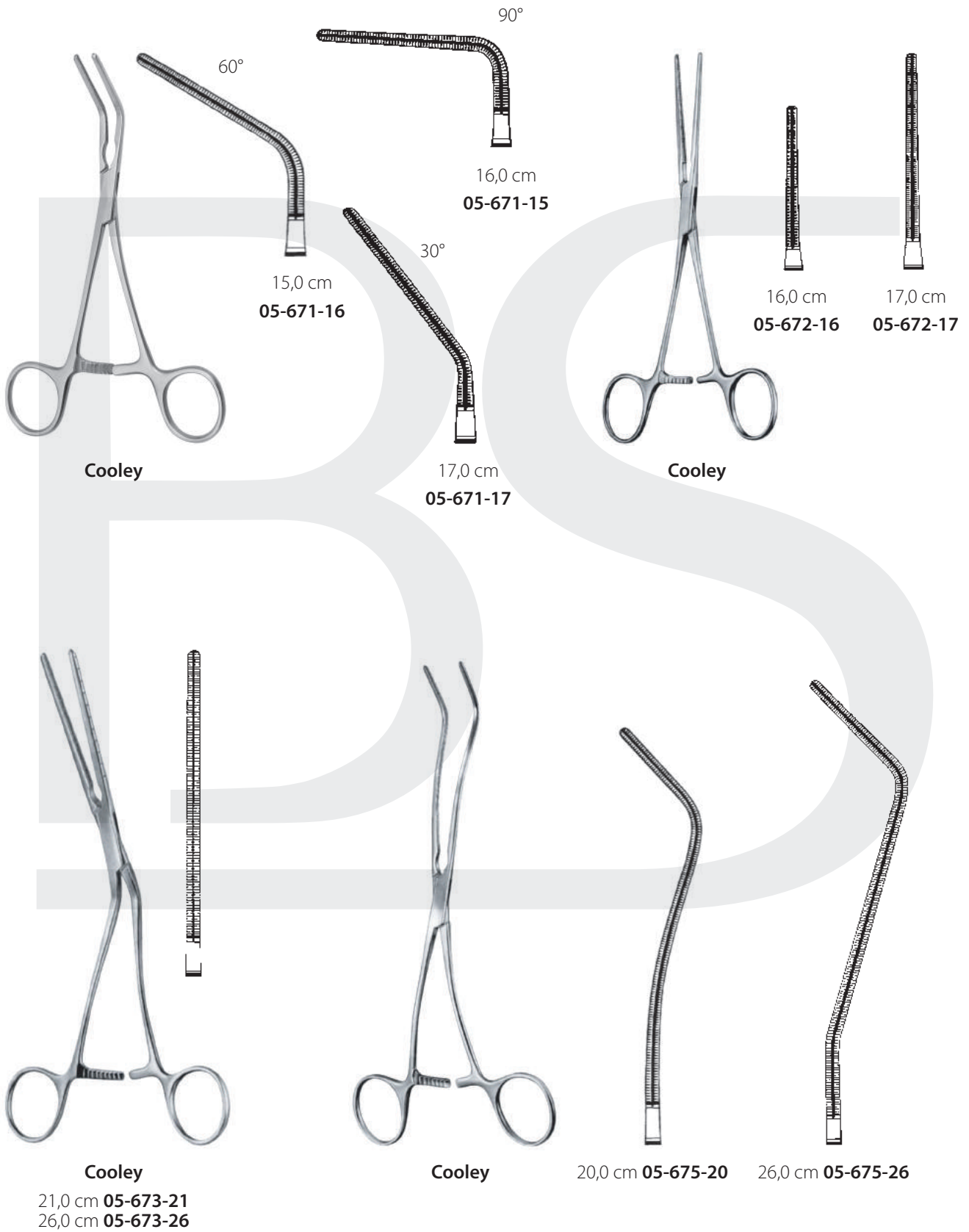

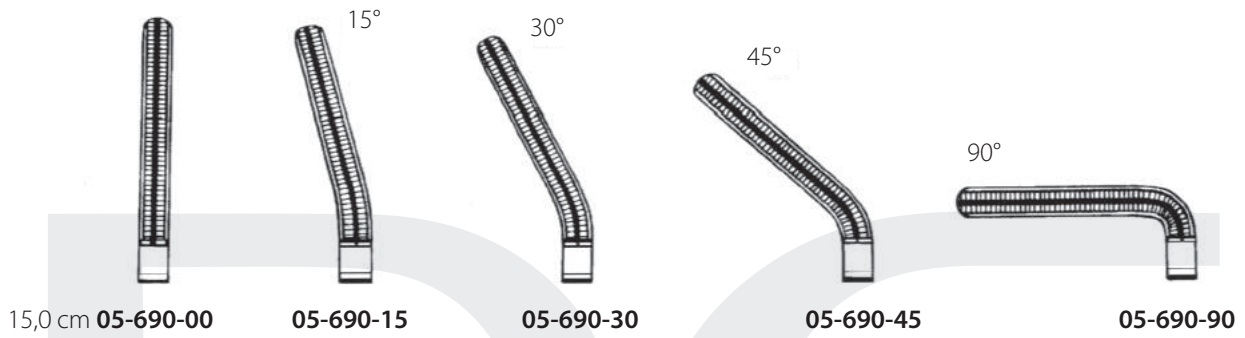

Dardik

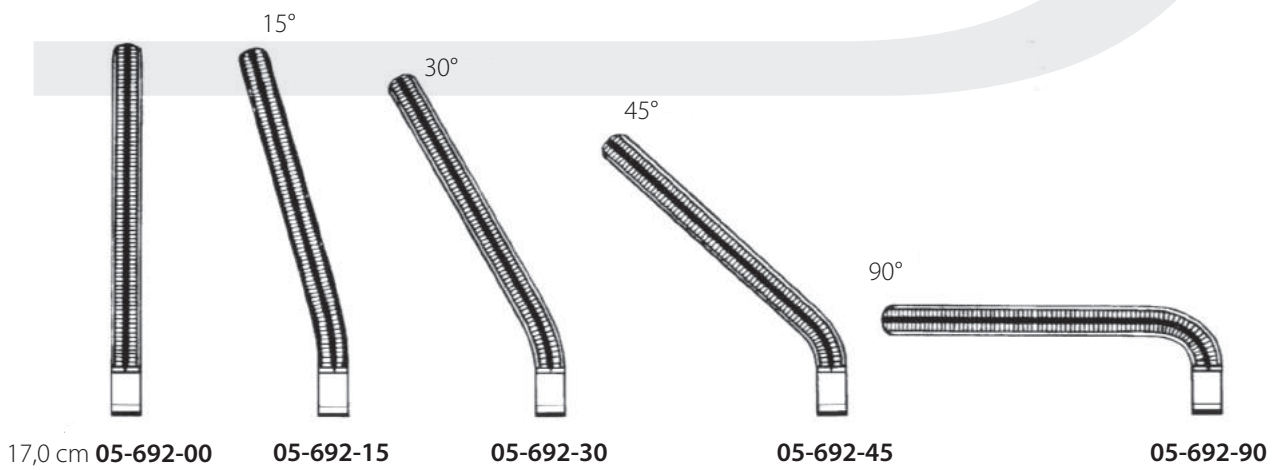

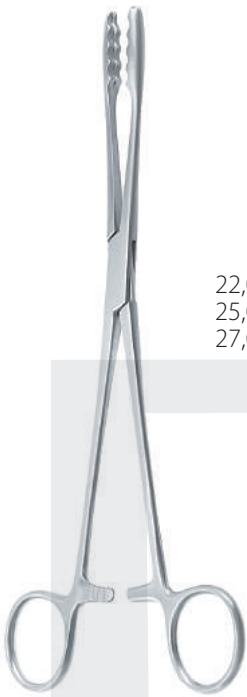

Ulrich

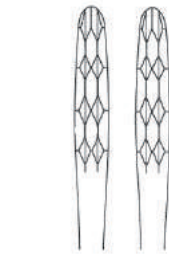

22,0 cm **05-700-22**
25,0 cm **05-700-25**
27,0 cm **05-700-27**

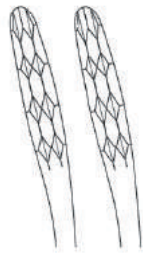

22,0 cm **05-701-22**
25,0 cm **05-701-25**
27,0 cm **05-701-27**



14,0 cm **05-702-14**
18,0 cm **05-702-18**
20,0 cm **05-702-20**
22,0 cm **05-702-22**
27,0 cm **05-702-27**

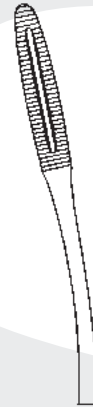

14,0 cm **05-703-14**
18,0 cm **05-703-18**
20,0 cm **05-703-20**
22,0 cm **05-703-22**
27,0 cm **05-703-27**



Gross-Maier



05-711-17



Lister, Sinus



13,0 cm
05-714-13



16,0 cm
05-714-16



18,0 cm
05-714-18

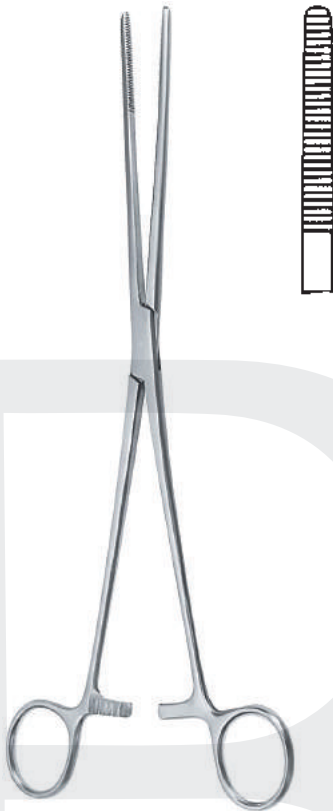

Bozemann
26,0 cm 05-716-26

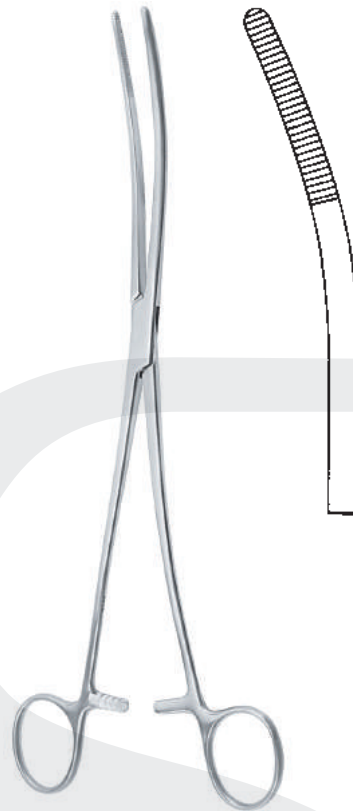

Bozemann
26,0 cm 05-717-26

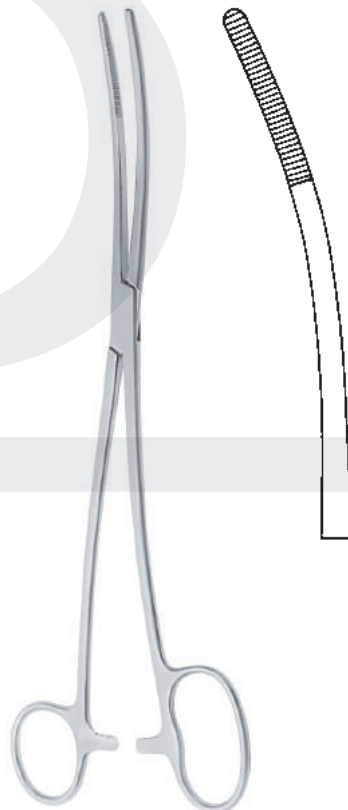

Bozemann
26,0 cm 05-719-26

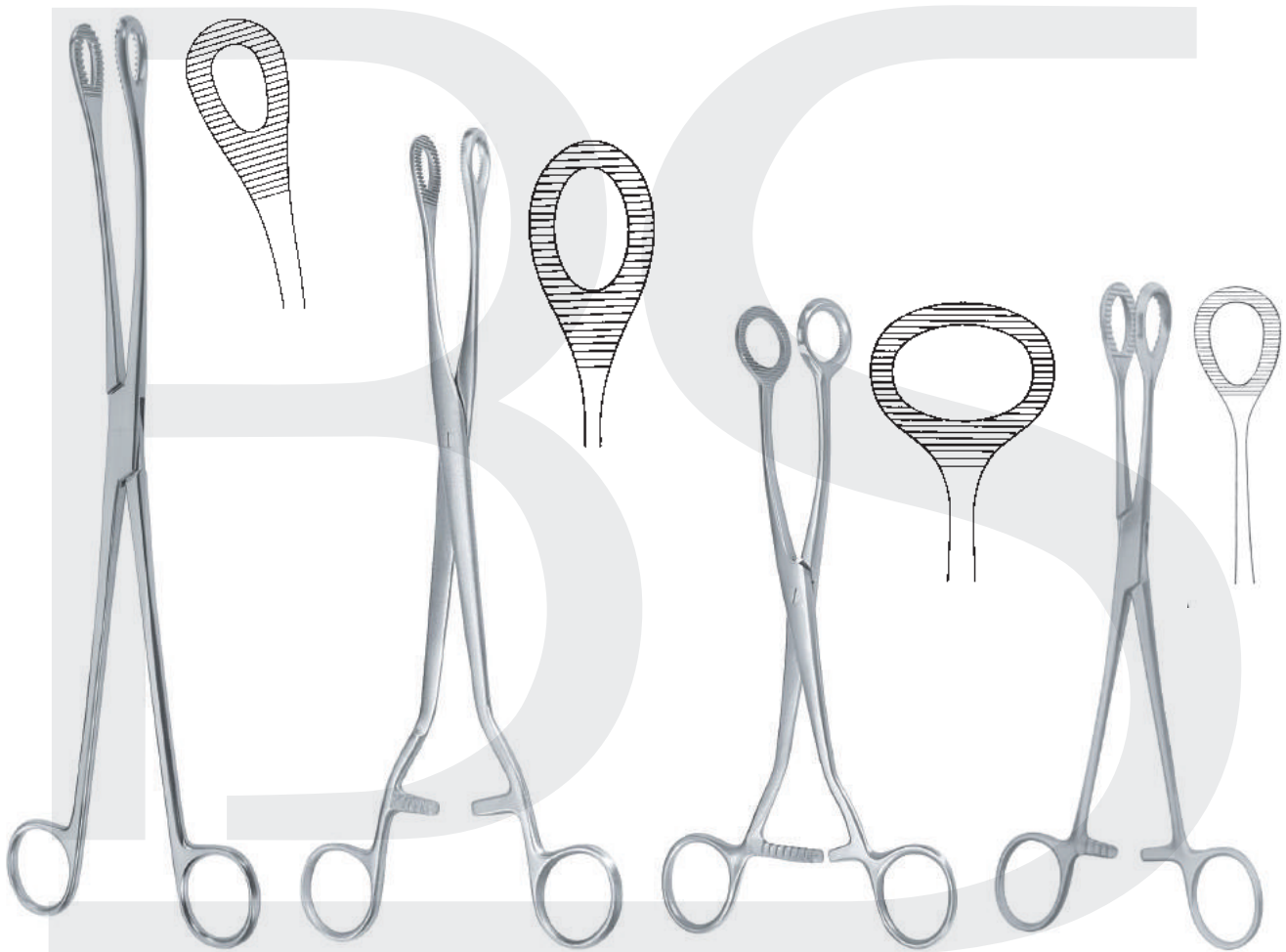

Kelly
32,0 cm **05-725-32**

Noto
27,0 cm **05-726-27**

Doyen
20,5 cm **05-730-21**

Heywood - Smith
21,0 cm **05-730-22**
25,0 cm **05-730-25**



25,0 cm **05-732-25**



26,0 cm **05-732-26**



Polypen Atrauma Fasszange
 Atrauma Tissue Grasping Forceps

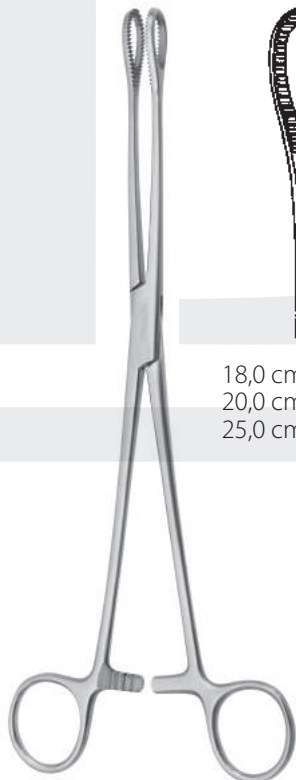

Förster-Ballenger Fasszange
 Grasping Forceps



18,0 cm **05-736-18**
 20,0 cm **05-736-20**
 25,0 cm **05-736-25**



18,0 cm **05-737-18**
 20,0 cm **05-737-20**
 25,0 cm **05-737-25**

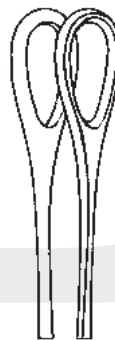

18,0 cm **05-738-18**
 20,0 cm **05-738-20**
 25,0 cm **05-738-25**



18,0 cm **05-739-18**
 20,0 cm **05-739-20**
 25,0 cm **05-739-25**

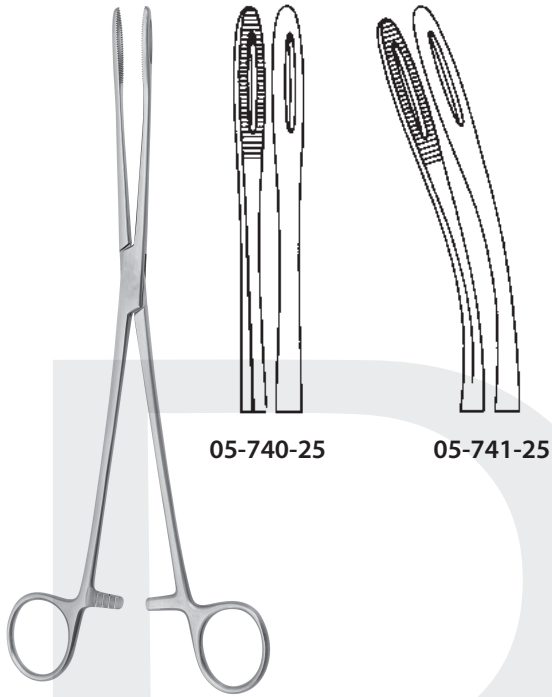

Förster
25,0 cm

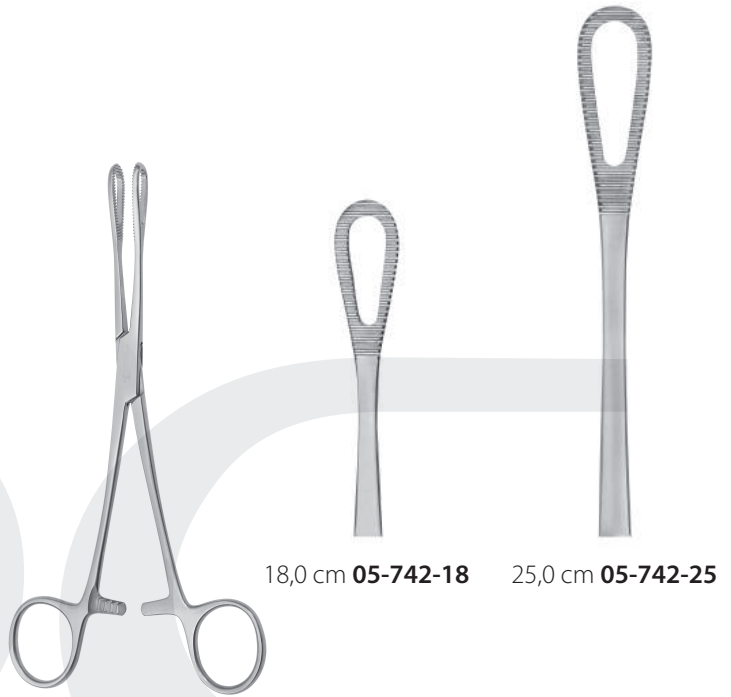

Rampley

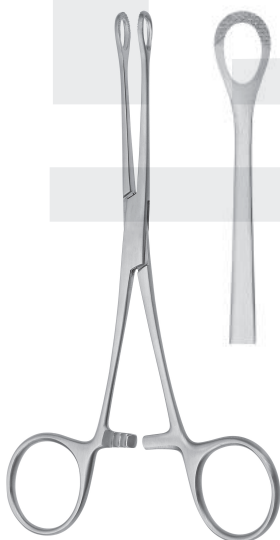

Williams
16,0 cm 05-744-16



Collin
14,0 cm 05-750-14

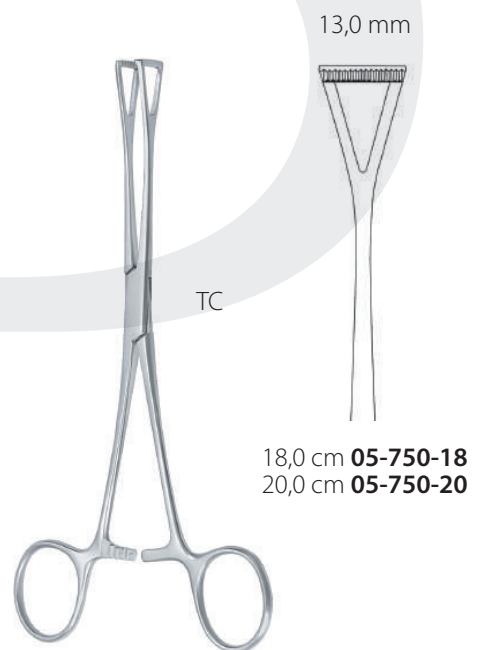

Duval

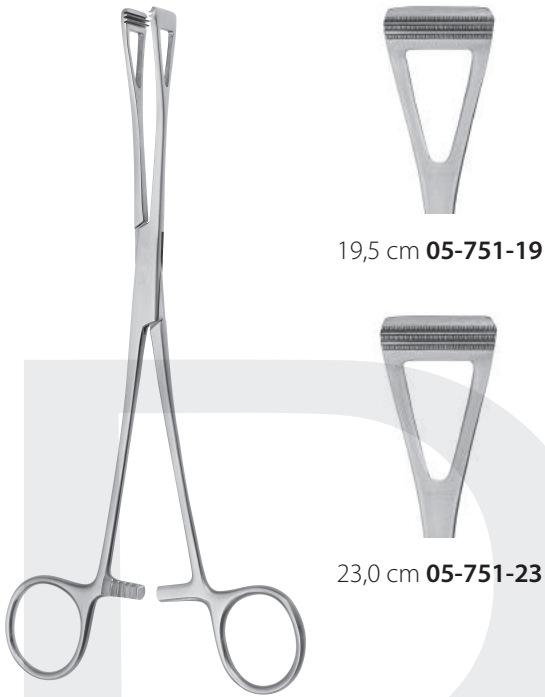

Collin, Atrauma

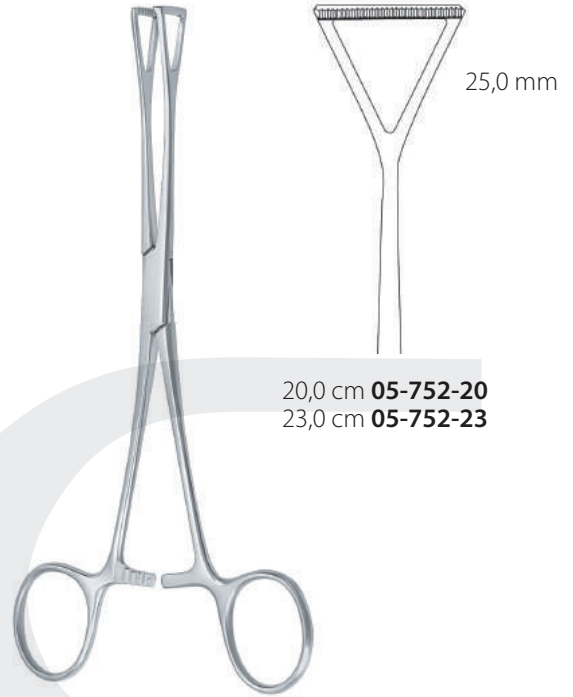

Duval



05-754-20

Lovelace
20,0 cm

05-755-20

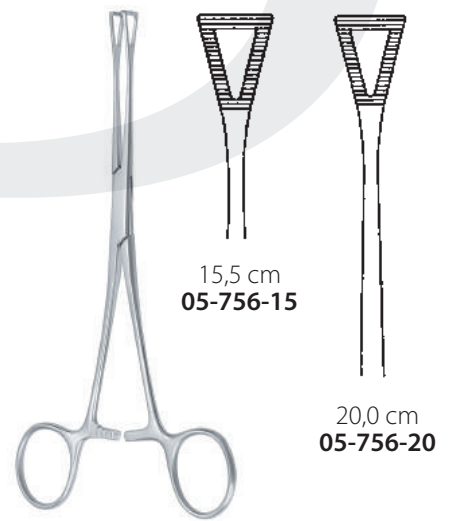

Pennington

15,5 cm
05-756-15

20,0 cm
05-756-20

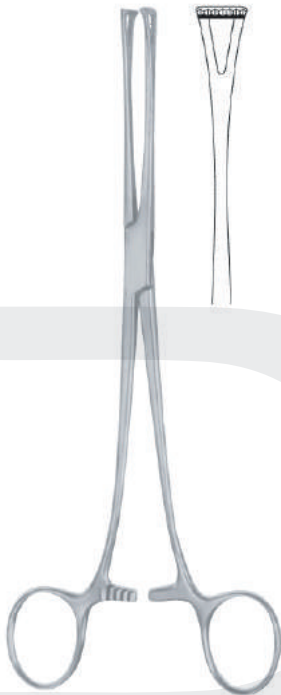

Lockwood

20,0 cm **05-758-20**



Babcock

16,0 cm **05-760-16**
18,0 cm **05-760-18**
20,0 cm **05-760-20**
24,0 cm **05-760-24**



16,0 cm **05-762-16**

20,0 cm **05-762-20**



Babcock, Atrauma



16,0 cm **05-764-16**

20,0 cm **05-764-20**



Babcock TC



Baby-Allis,
12,0 cm **05-766-12**

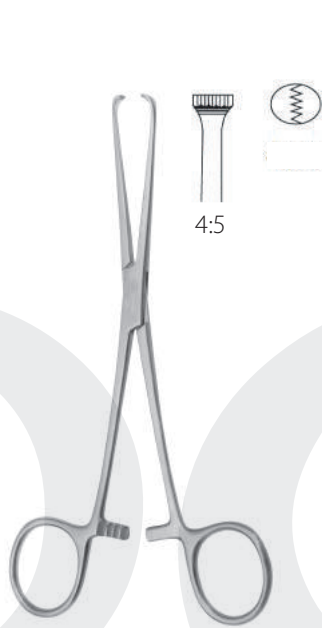

Allis
15,0 cm **05-766-14**

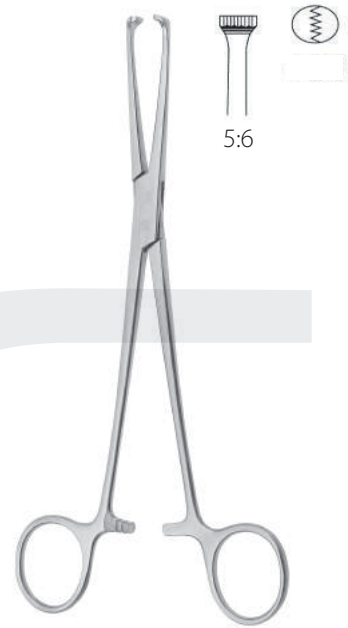

Allis
15,0 cm **05-766-15**
19,0 cm **05-766-19**
25,0 cm **05-766-25**

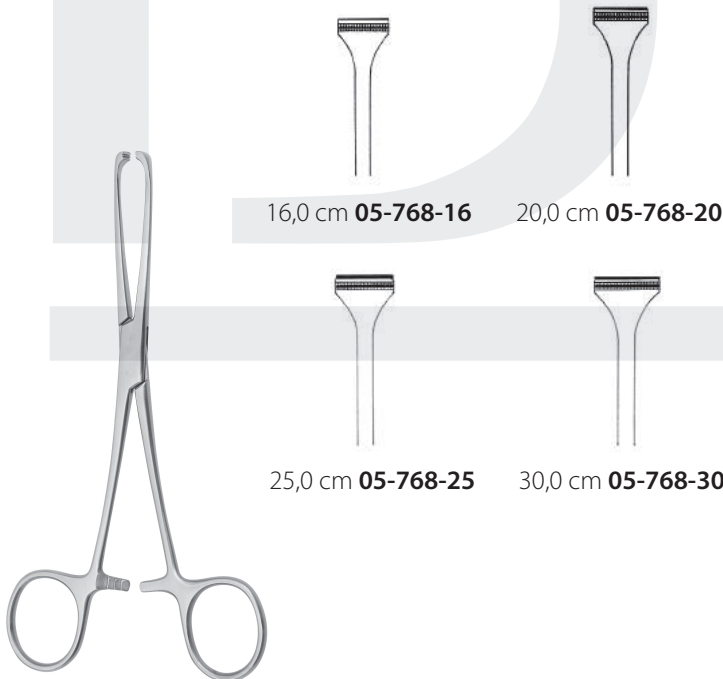

Allis Atrauma

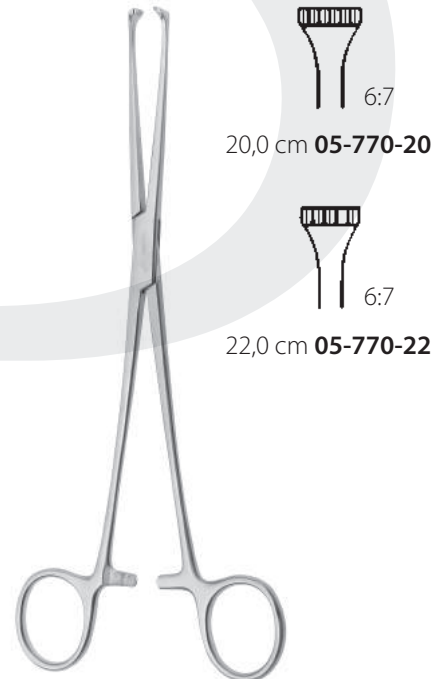

Allis-Thoms



Allis
20,0 cm **05-771-20**



Judd-Allis
15,0 cm **05-772-15**
19,0 cm **05-772-19**



Boys-Allis
15,0 cm **05-774-15**



Allis-Adair
15,0 cm **05-776-15**



Tuffier
13,0 cm **05-778-13**



Chaput
13,0 cm **05-780-13**



Martel
14,0 cm **05-786-14**



Backhaus

9,0 cm **05-801-08**
11,0 cm **05-801-11**
13,0 cm **05-801-13**
15,0 cm **05-801-15**



mit Schlauchhalter / with tube holder

Backhaus

11,0 cm **05-803-11**



schlank / narrow

Backhaus

11,0 cm **05-804-11**
13,0 cm **05-804-13**



Tuchklemme

Towel Forceps

11,0 cm **05-805-11**
14,0 cm **05-805-14**



Bernhard

16,5 cm **05-807-16**



Roeder

13,0 cm **05-809-13**
15,0 cm **05-809-15**



Lane

13,0 cm **05-811-13**
15,0 cm **05-811-15**
20,0 cm **05-811-20**



Schädel

9,0 cm

05-816-09



05-817-09



Jones

9,0 cm **05-819-09**



Jones

9,0 cm **05-820-09**



Bertram

14,5 cm **05-821-14**



Lorna

10,0 cm **05-823-10**
13,0 cm **05-823-13**



Tohoku

10,0 cm **05-825-10**
13,0 cm **05-825-13**

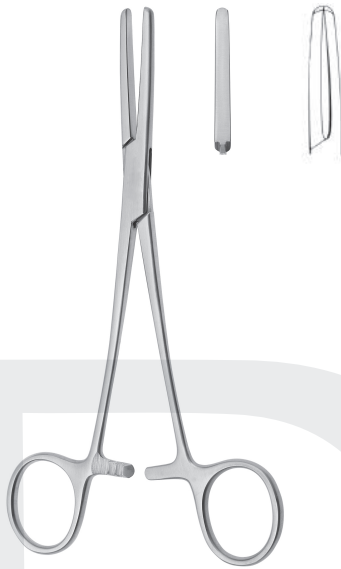

Presbyterian

16,0 cm **05-840-16**
18,0 cm **05-840-18**
20,0 cm **05-840-20**



Klinikum Berlin

14,5 cm **05-842-14**
16,0 cm **05-842-16**

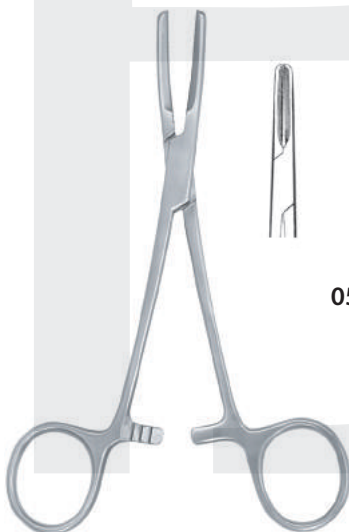

15,0 cm **05-844-15** 18,0 cm **05-844-18** 20,0 cm **05-844-20**



14,0 cm
05-851-13

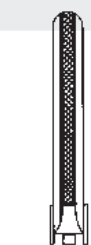

20,0 cm **05-846-20** 18,0 cm **05-846-18** 15,0 cm **05-846-15**



mit Schutzbügel
with Protector

Wundhaken
Retractor

06



Maßangaben für Blattgrößen der Wundhaken

Maß 1 - Tiefe

Maß 2 - Breite

Beispiel: 24 x 42 mm

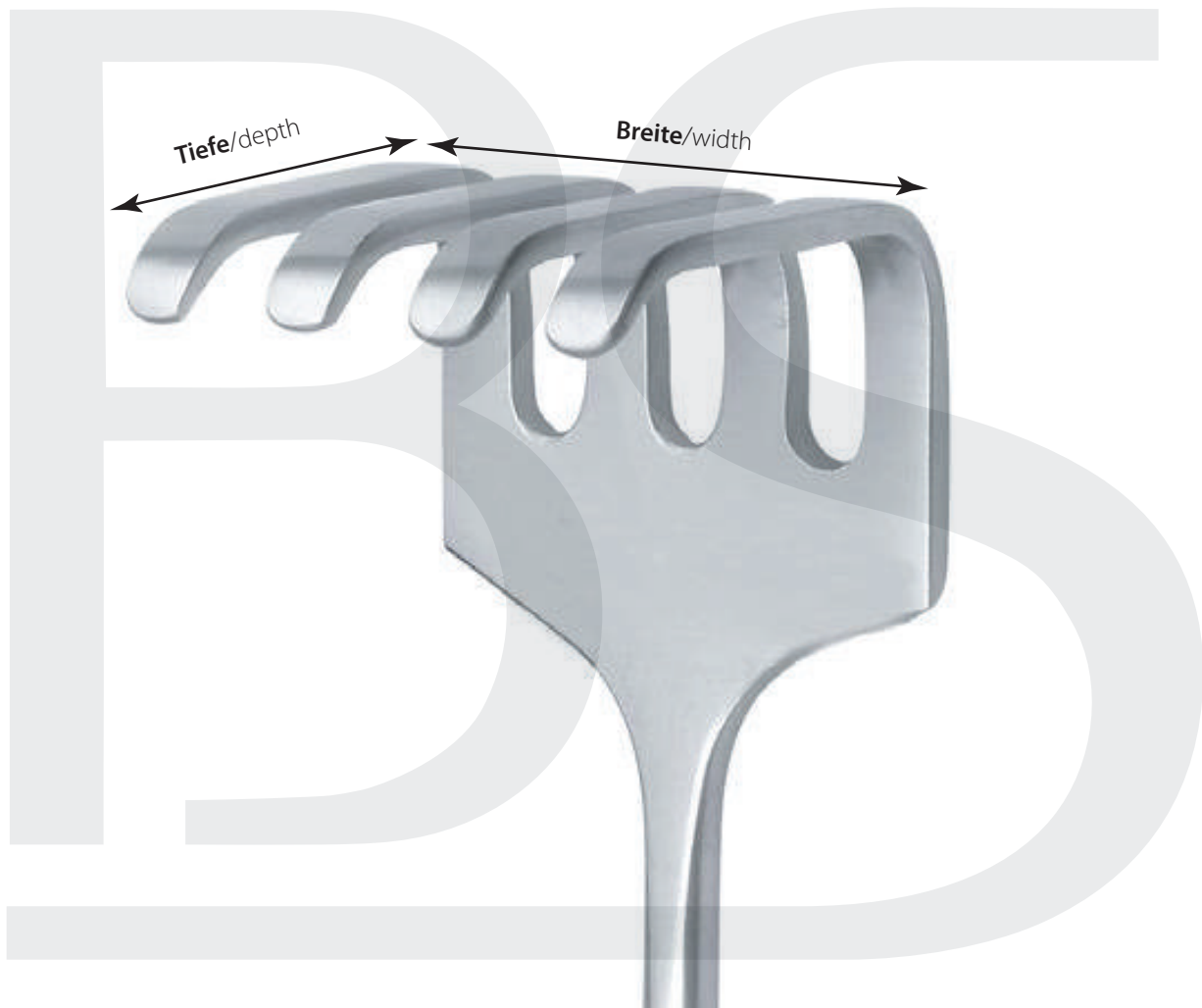

Dimensions for blade size of retractors

Measure 1 - depth

Measure 2 - width

Example: 24x42 mm

Wundhaken
Retractors

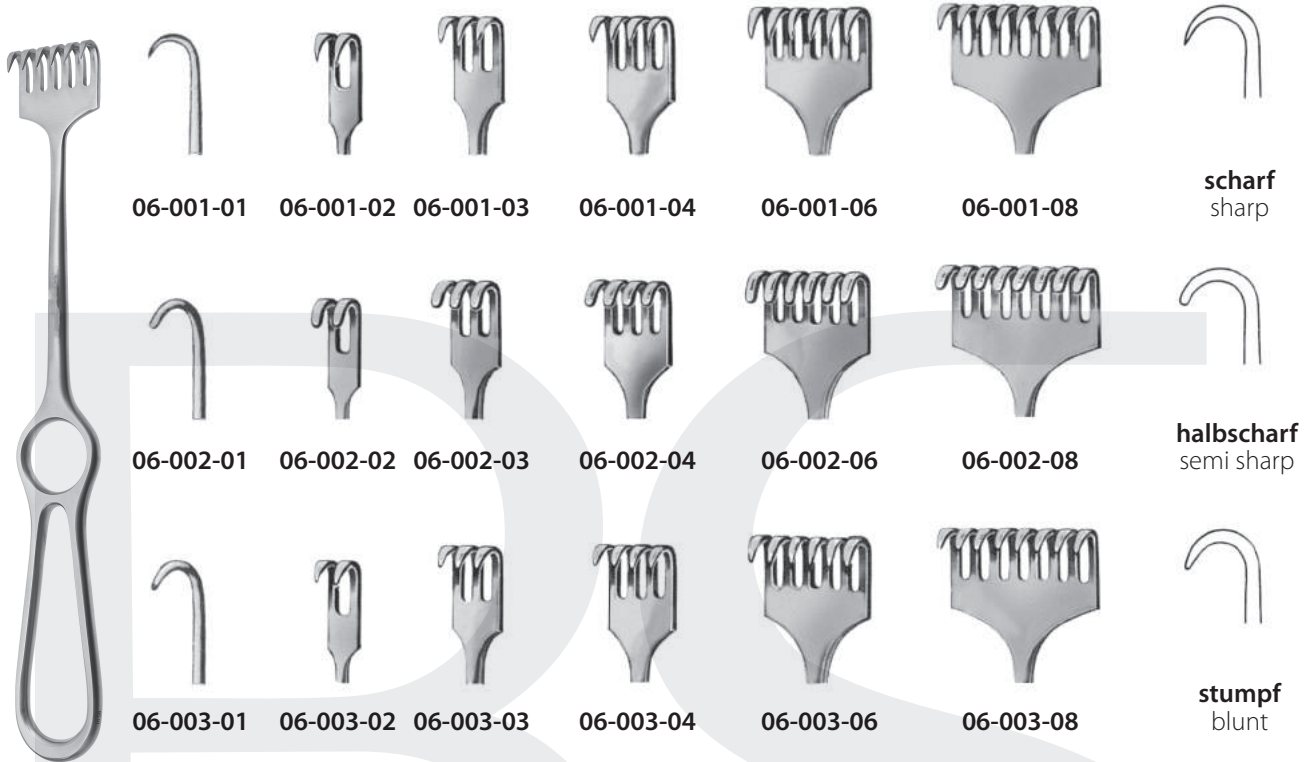

Volkmann
22,0 cm

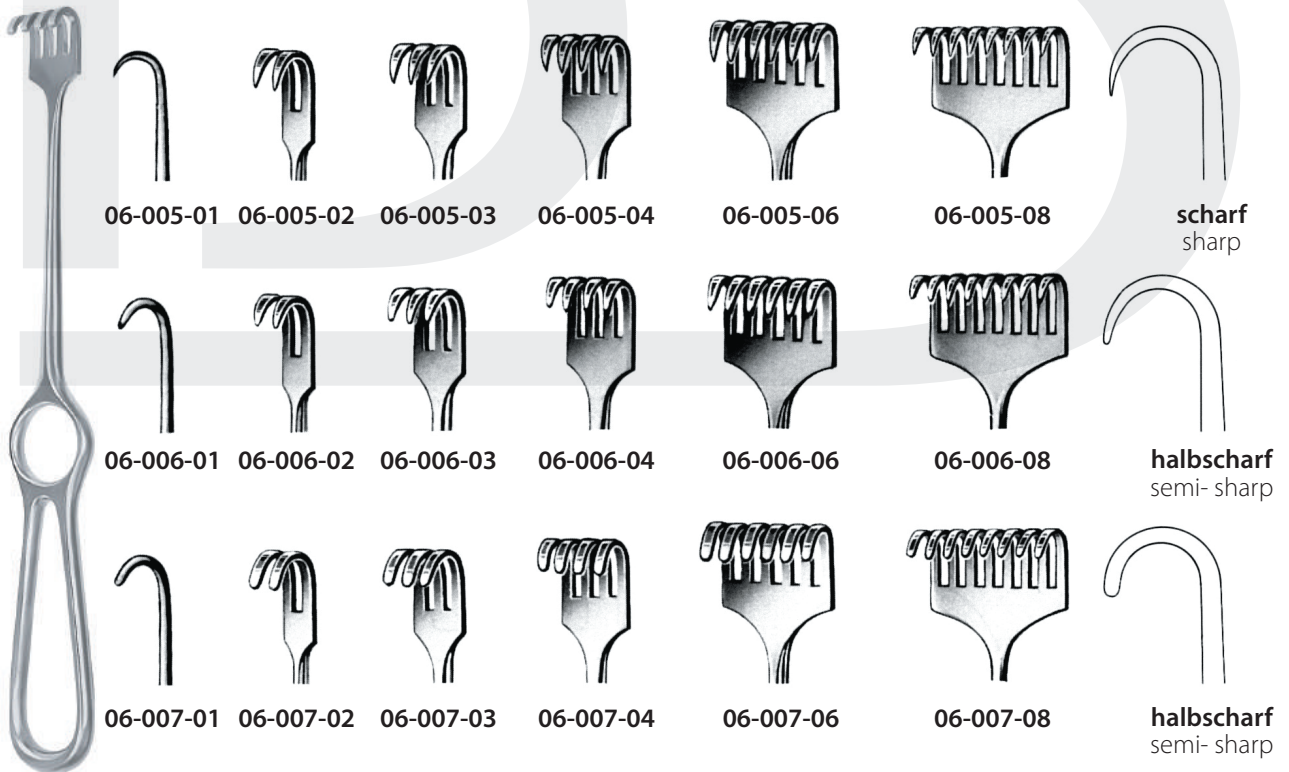

Volkmann
22,0 cm

06



Volkmann
22,0 cm



06-008-01



06-008-02



06-008-03



06-008-04



06-008-06



scharf
sharp



06-009-01



06-009-02



06-009-03



06-009-04



06-009-06



stumpf
blunt

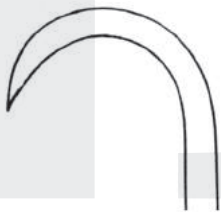

06-010-01



06-010-02



06-010-03



06-011-01

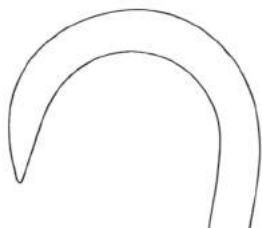

06-012-01

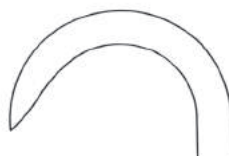

06-012-12

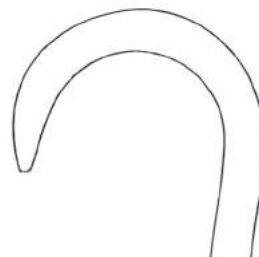

06-013-01



Volkmann
22,0 cm

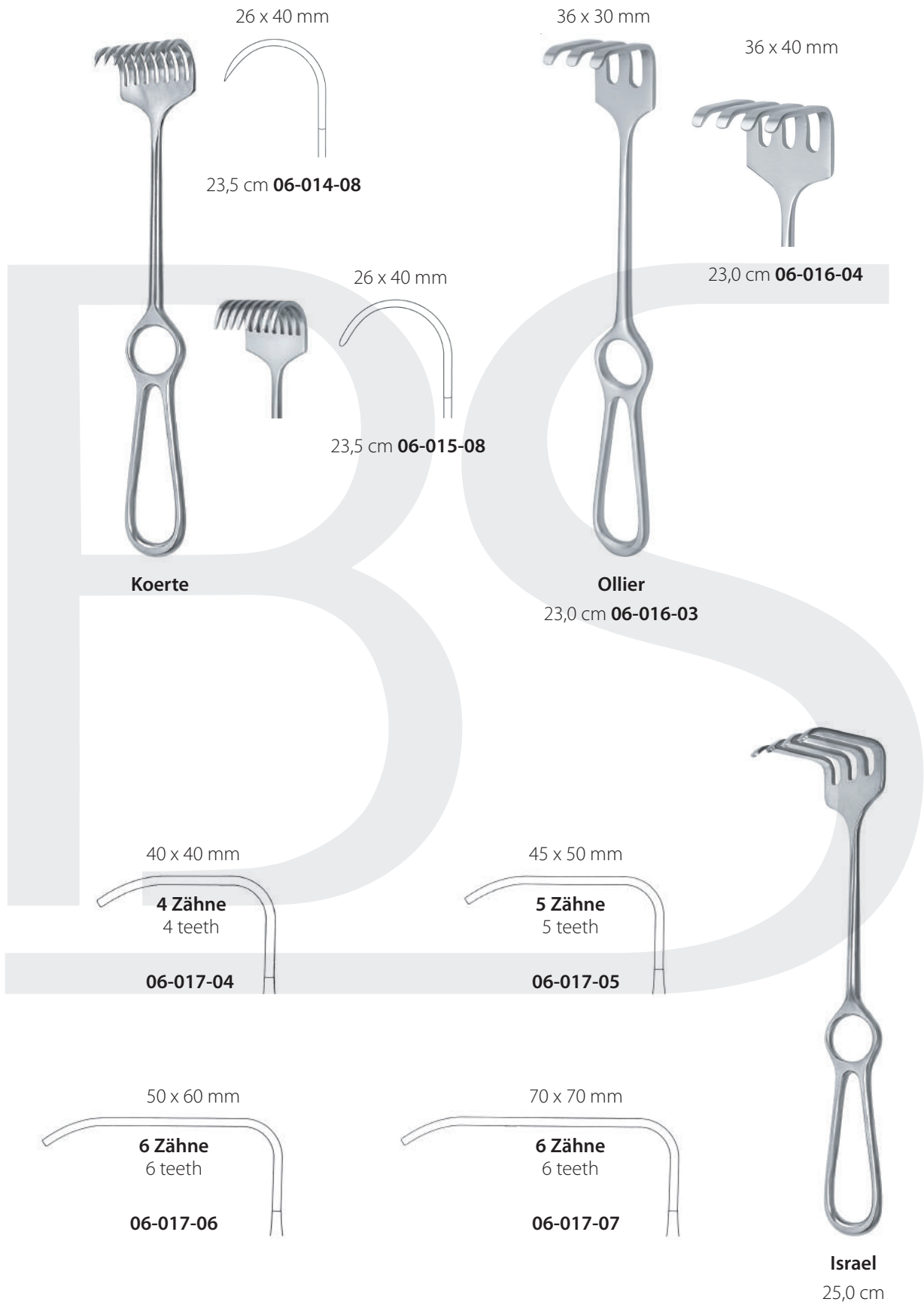

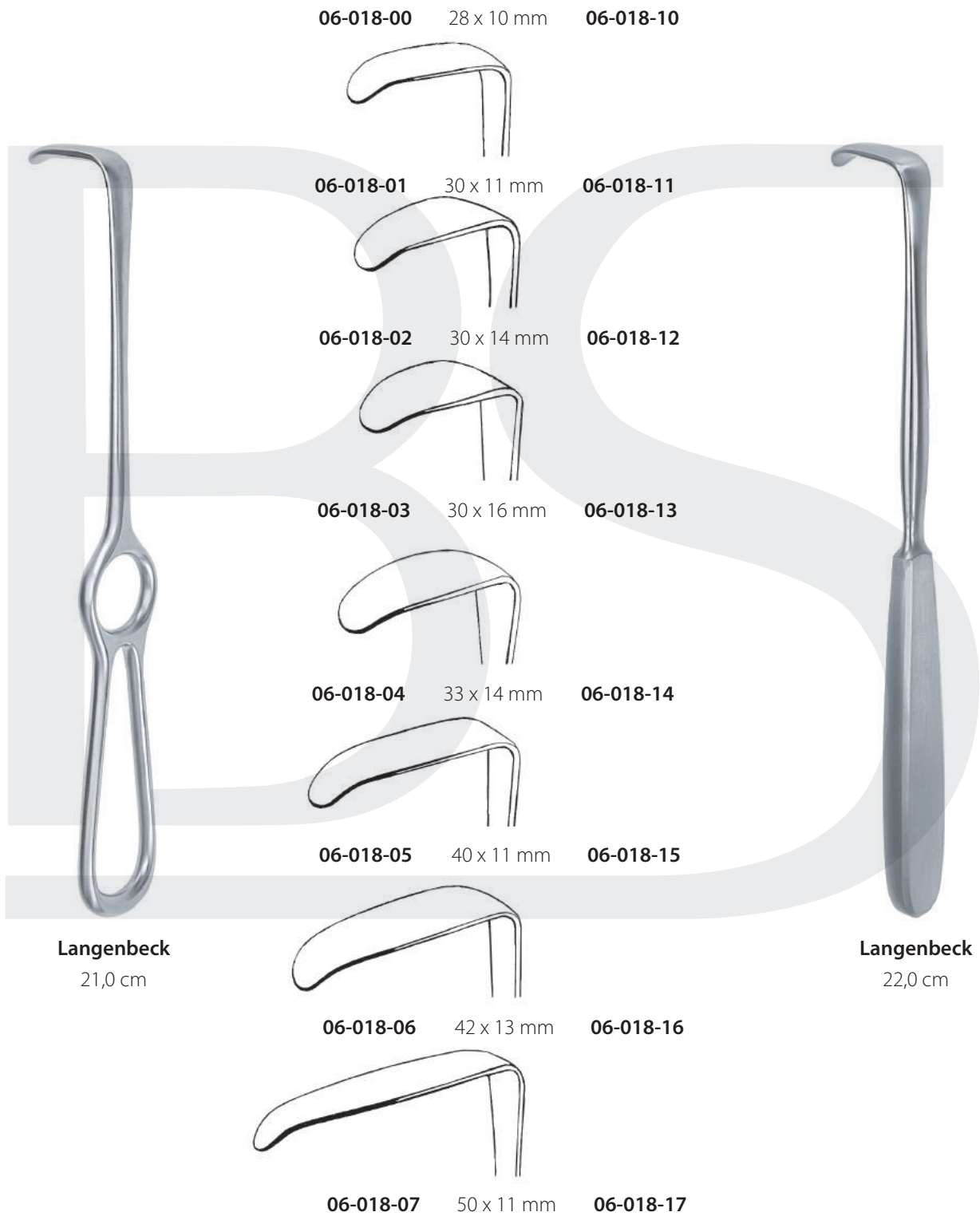

85 x 15 mm

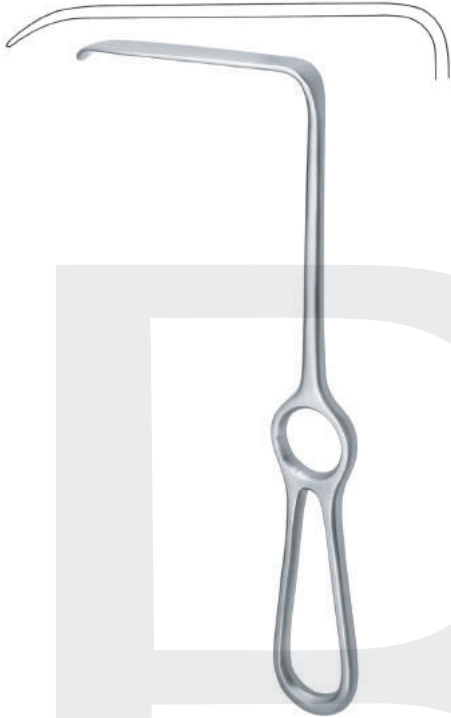

Langenbeck
22,0 cm **06-019-01**



Obwegeser
22,0 cm



25 x 7 mm

06-018-12

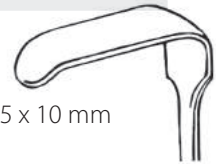

35 x 10 mm

06-018-12

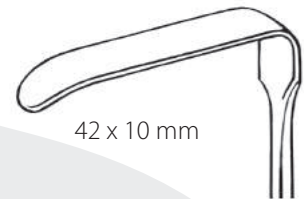

42 x 10 mm

06-018-12

60 x 20 mm



Langenbeck
21,0 cm **06-020-01**
22,0 cm **06-020-02**



55 x 12 mm

06-018-12

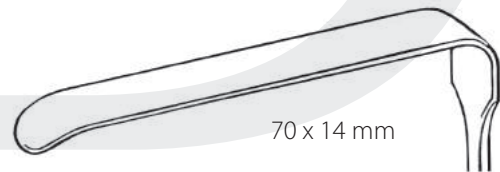

70 x 14 mm

06-018-12

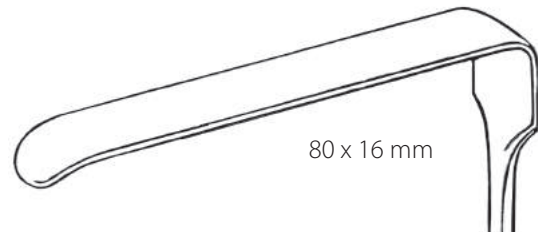

80 x 16 mm

06-018-12

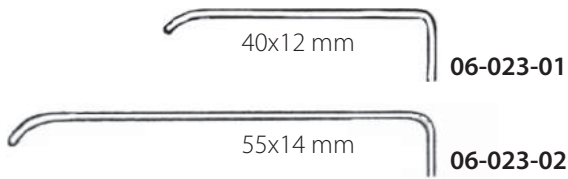

Dockhorn
21,0 cm



Kocher-Langenbeck
22,0 cm

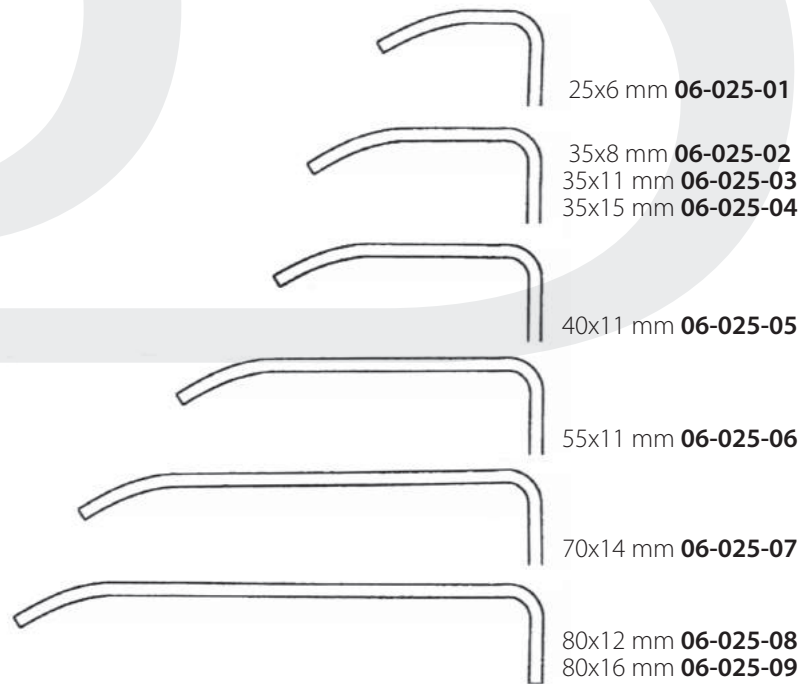



Zenker

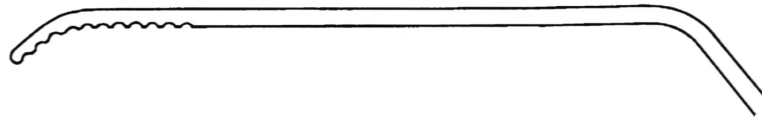

27,5 cm 120x12 mm **06-026-04**



27,5 cm 75x12 mm **06-026-03**



26,0 cm 60x12 mm **06-026-02**

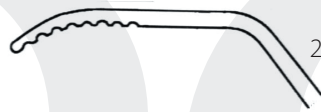

25,0 cm 35x8 mm **06-026-01**



40x18 mm **06-027-01**



60x20 mm **06-027-02**

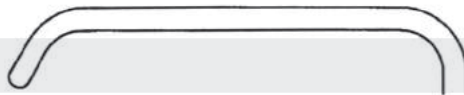

60x25 mm **06-027-03**



75x30 mm **06-027-04**

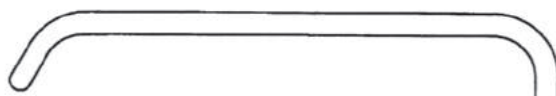

75x40 mm **06-027-05**



Kocher
23,0 cm

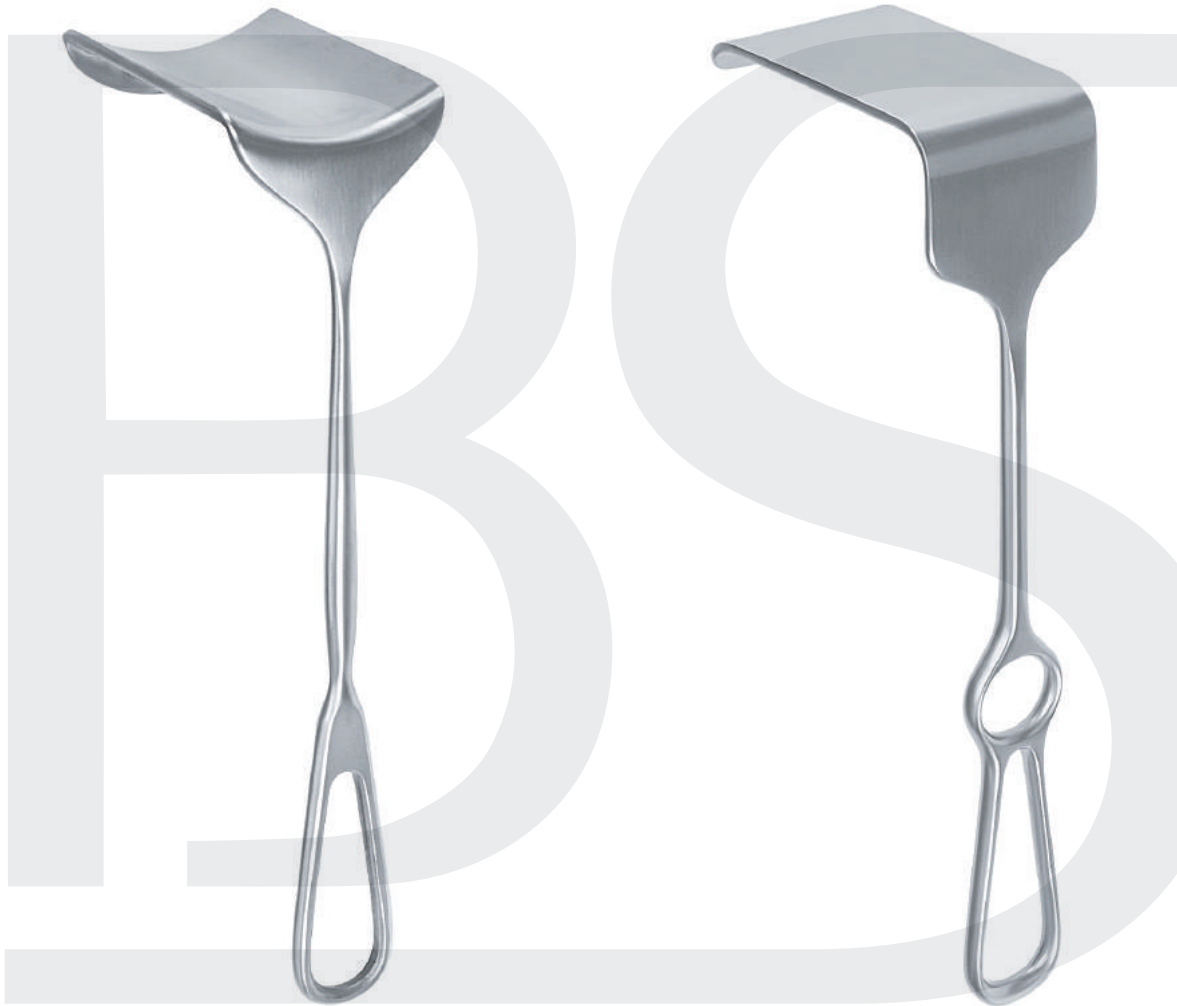

Morris, 24,5 cm
06-027-11 70 x 40 mm
06-027-12 70 x 50 mm
06-027-13 70 x 65 mm

Mikulicz, 26,0 cm
06-028-01 80 x 50 mm



Sauerbruch
25,0 cm 06-029-03



82x22 mm
Coryllos
25,0 cm 06-030-01



110x40 mm
Coryllos
25,0 cm 06-030-02



115x65 mm
Coryllos
25,0 cm 06-030-03

180x30 mm **06-031-06**

160x30 mm **06-031-05**

140x30 mm **06-031-04**

130x30 mm **06-031-07**

120x25 mm **06-031-03**

100x25 mm **06-031-02**

80x20 mm **06-031-01**

180x30 mm **06-032-06**

160x30 mm **06-032-05**

140x25 mm **06-032-04**

120x25 mm **06-032-03**

100x20 mm **06-032-02**

80x20 mm **06-032-01**

Brunner
26,0 cm



Kocher, 20,5 cm

19x12 mm **06-033-01**
21x14 mm **06-033-02**



Kocher

22,0 cm

40x10 mm

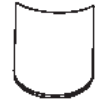

06-034-01

40x15 mm

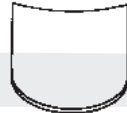

06-034-02

40x20 mm

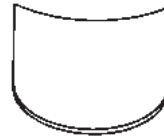

06-034-03

14x17 mm



06-035-01

20x22 mm



06-035-02

26x30 mm



06-035-03



Middeldorpf

22,0 cm / 27,0 cm

45x45 mm



06-036-01

45x50 mm



06-036-02

55x70 mm



06-036-03



Kümmel, 100x45 mm
28,0 cm **06-037-28**



Doyen, 50x85 mm
25,0 cm **06-038-25**
26,0 cm **06-038-26**

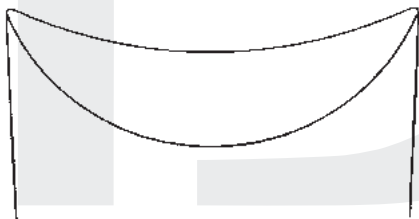

24,0 cm 40x60 mm **06-039-03**

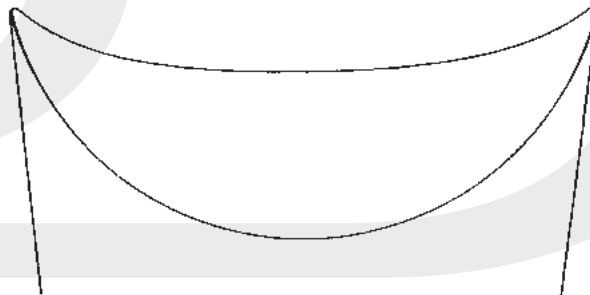

24,0 cm 40x85 mm **06-039-05**



24,0 cm 40x50 mm **06-039-02**

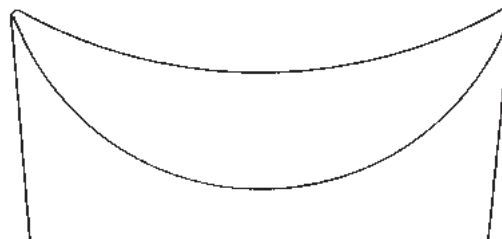

24,0 cm 40x75 mm **06-039-04**



24,0 cm 40x40 mm **06-039-01**



Fritsch

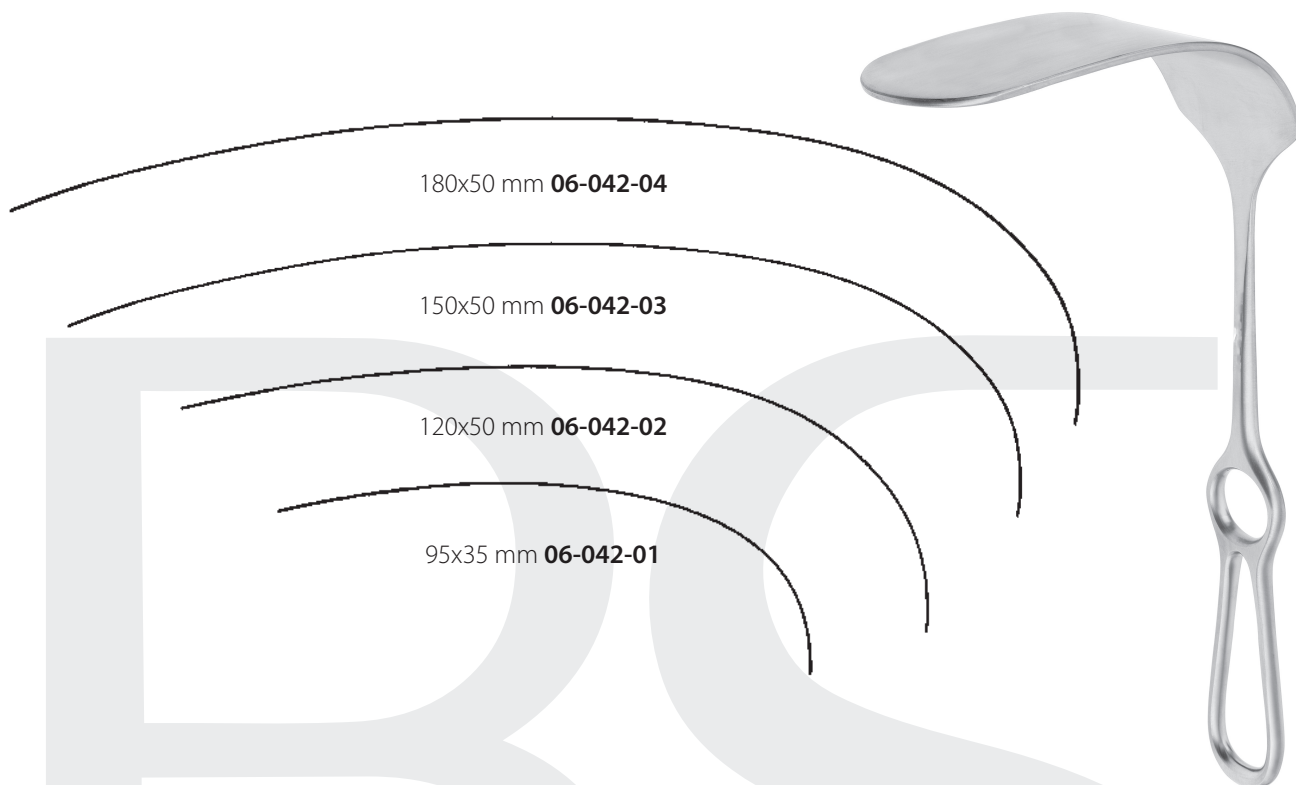

Mikulicz
25,0 cm



Kocher, 22,5 cm
70x25 mm **06-040-01**



Kocher, 25,0 cm
80x45 mm **06-041-01**
80x55 mm **06-041-02**
80x65 mm **06-041-03**



190x57 mm **06-043-02**
155x57 mm **06-043-04**



190x38 mm **06-043-01**
155x38 mm **06-043-03**



90x28 mm **06-044-01**
105x30 mm **06-044-02**
120x52 mm **06-044-03**



Kelly
27,0 cm



Wertheim
22,0 cm

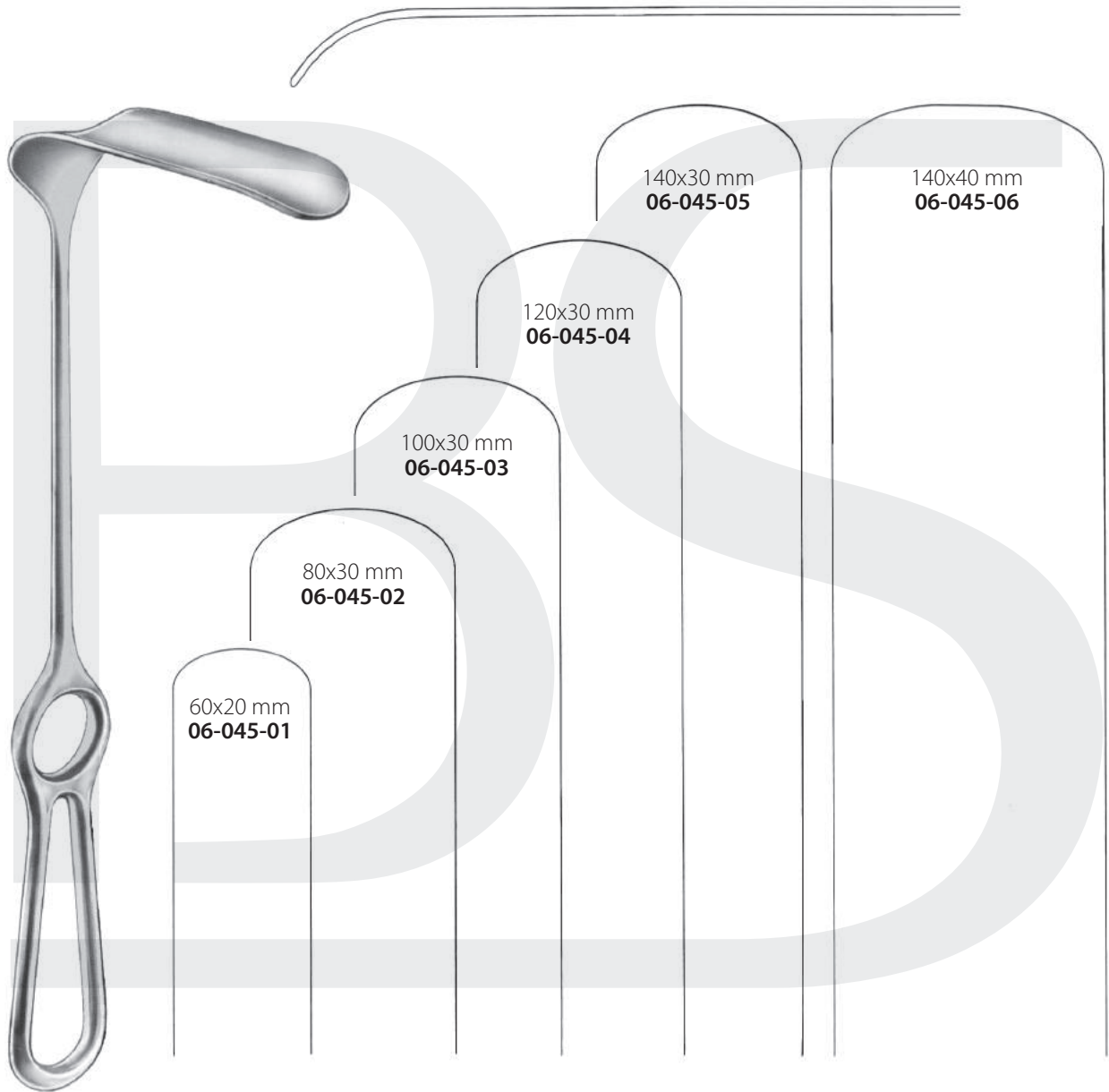

06

Hösel
25,0 cm



Harrington

40x320mm **06-046-01**
62x320mm **06-046-02**

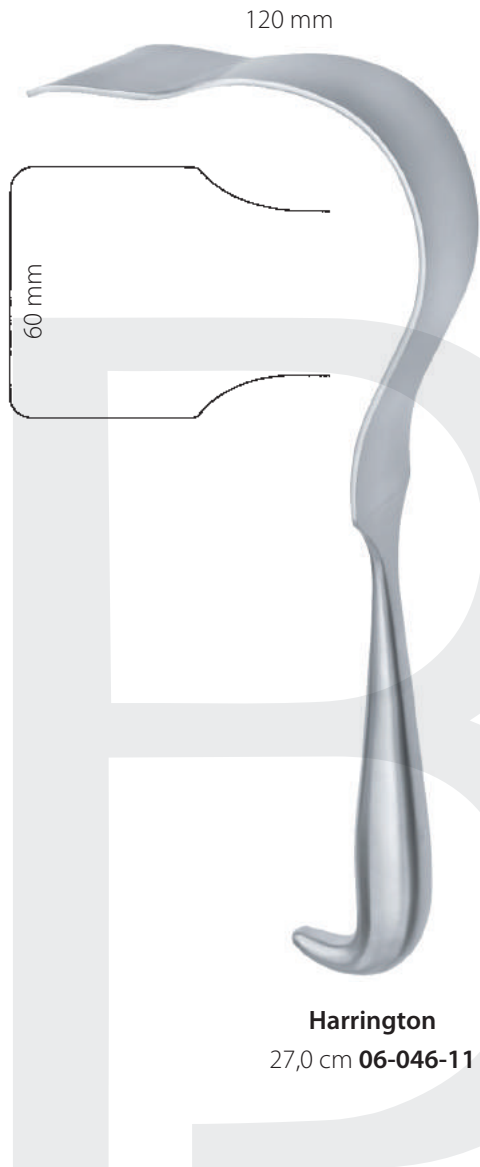



Richardson-Eastman,
27,0 cm Satz / Set **06-047-00**



Kelly

26,0 cm **06-047-27**



Richardson

24,0 cm **06-047-11**



Kelly

26,0 cm **06-047-28**



Richardson

24,0 cm **06-047-12**



Richardson

24,0 cm **06-047-13**



Richardson/Kelly



Richardson

24,0 cm **06-047-14**



Kelly

26,0 cm **06-047-25**



Kelly

26,0 cm **06-047-26**

75x90 mm **06-047-90**
75x50 mm **06-047-50**



Davidson

26,5 cm 95x20 mm **06-048-01**



Modell Tübingen

25,0 cm 105x27 mm **06-048-02**



Martin

27,5 cm 115x22 mm **06-048-03**
27,5 cm 115x26 mm **06-048-04**



Simon

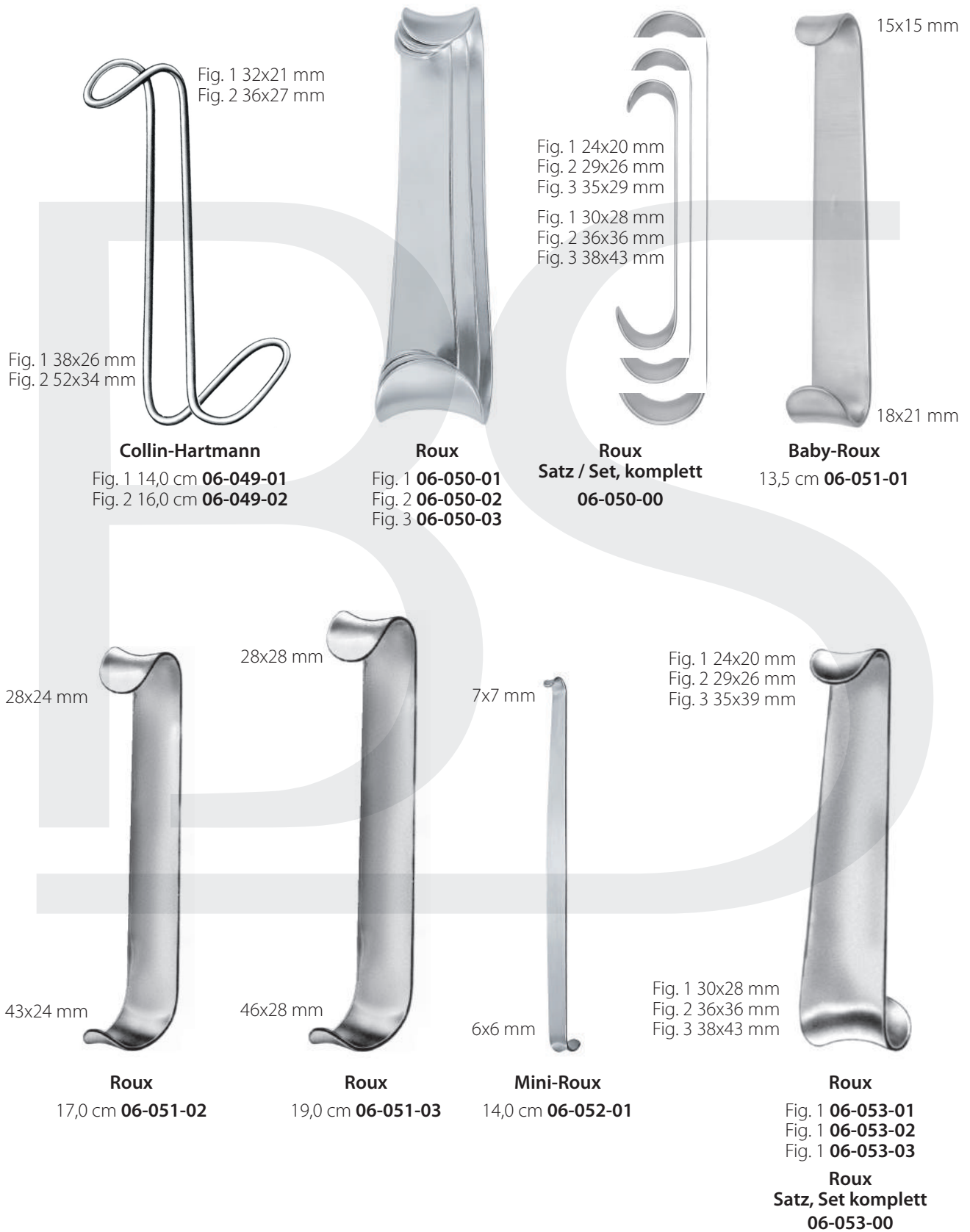

Fig. 1 26x25 mm
Fig. 2 29x25 mm



Fig. 1 24x25 mm
Fig. 2 27x25 mm

Parker

17,5 cm **06-054-00**

Fig. 1 19x15 mm
Fig. 2 22x15 mm



Fig. 1 19x15 mm
Fig. 2 22x15 mm

Parker-Baby

14,0 cm **06-055-00**

Fig. 1 23x16 mm
Fig. 2 27x16 mm



Fig. 1 26x16 mm
Fig. 2 30x16 mm

Farabeuf

15,0 cm **06-056-00**

Fig. 1 21x15 mm
Fig. 2 25x15 mm



Fig. 1 40x15 mm
Fig. 2 45x15 mm

Parker-Langenbeck

22,0 cm **06-058-00**

Fig. 1 42x13 mm
Fig. 2 47x13 mm



Fig. 1 42x26 mm
Fig. 2 47x26 mm

Mathieu

21,0 cm **06-059-00**

Fig. 1 26x10 mm
Fig. 2 30x10 mm



Fig. 1 30x13 mm
Fig. 2 34x13 mm

Baby-Farabeuf

17,5 cm **06-054-00**

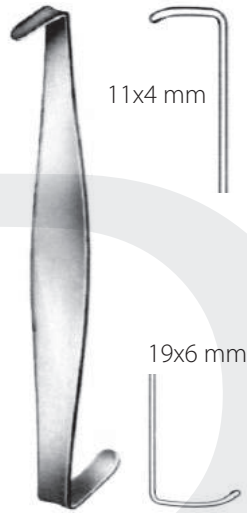

Crile
11,0 cm **06-060-11**



Goelet
19,0 cm **06-061-19**



Luer
11,0 cm **06-062-10**



Rose
13,0 cm **06-062-11**

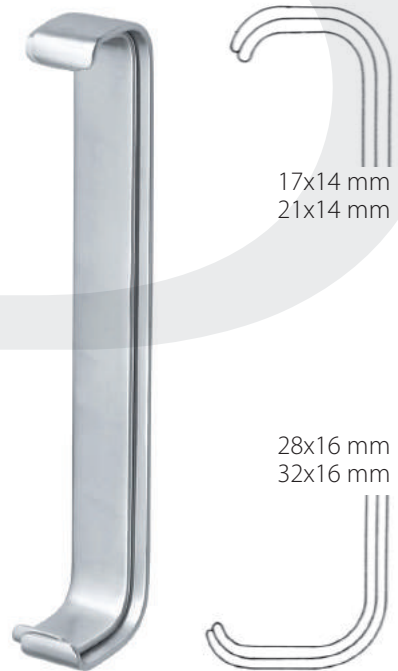

Collin
Satz/ Set 15,0 cm **06-063-00**

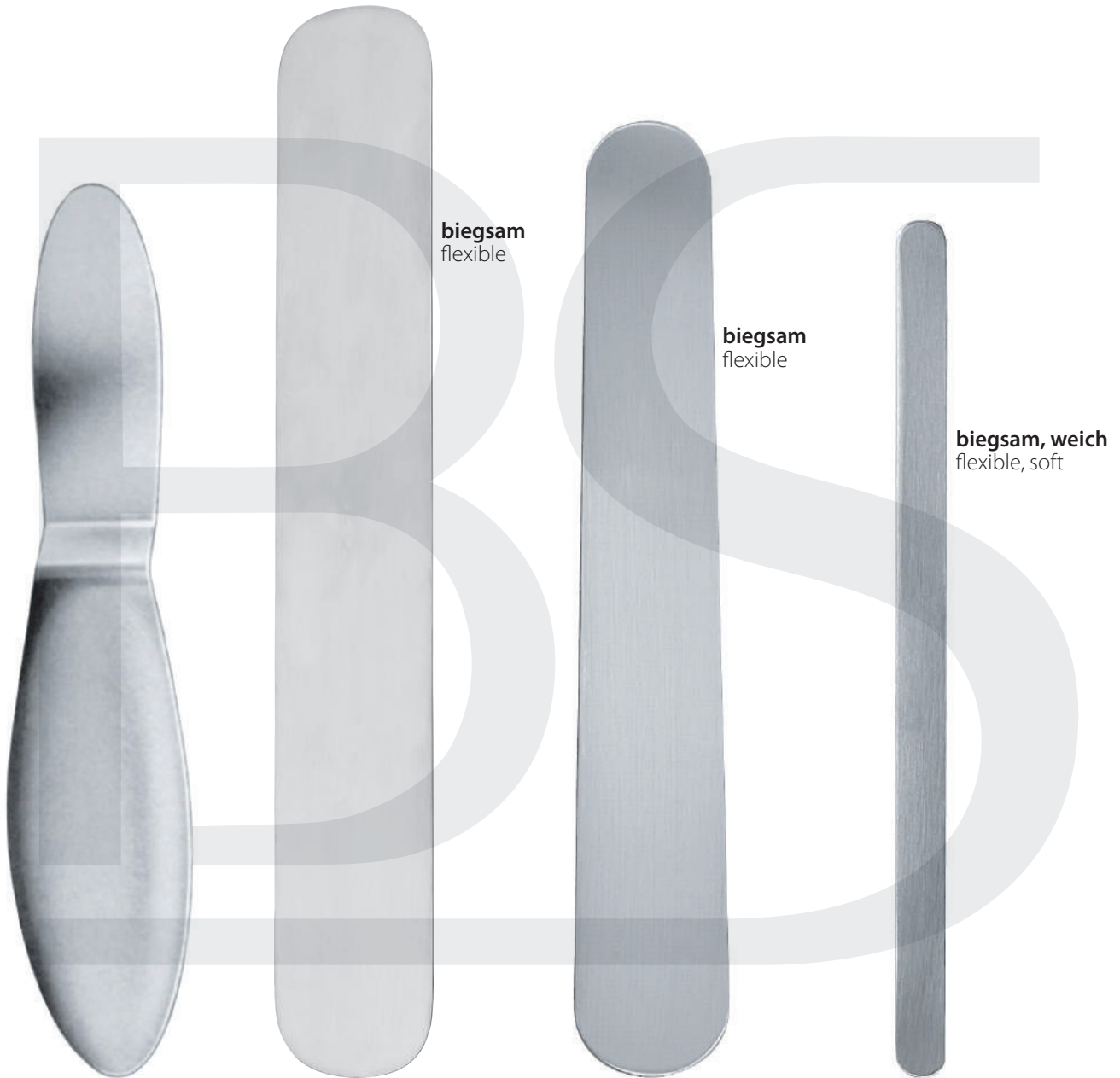

biegsam
flexible

biegsam
flexible

biegsam, weich
flexible, soft

Reverdin

28,0 cm **06-071-28**

- 330x20 mm **06-072-01**
- 330x25 mm **06-072-02**
- 330x30 mm **06-072-03**
- 330x40 mm **06-072-04**
- 330x50 mm **06-072-05**

Haberer

- 200x17/25 mm **06-073-01**
- 280x25/30 mm **06-073-02**
- 300x37/45 mm **06-073-03**
- 300x40/50 mm **06-073-04**

- 200x 6 mm **06-074-01**
- 200x 8 mm **06-074-02**
- 200x10 mm **06-074-03**
- 200x12 mm **06-074-04**
- 200x17 mm **06-074-05**
- 200x25 mm **06-074-06**
- 250x25 mm **06-074-07**
- 200x20 mm **06-074-08**



Leriche

25,5 cm **06-076-45** 45 mm
27,5 cm **06-076-60** 60 mm

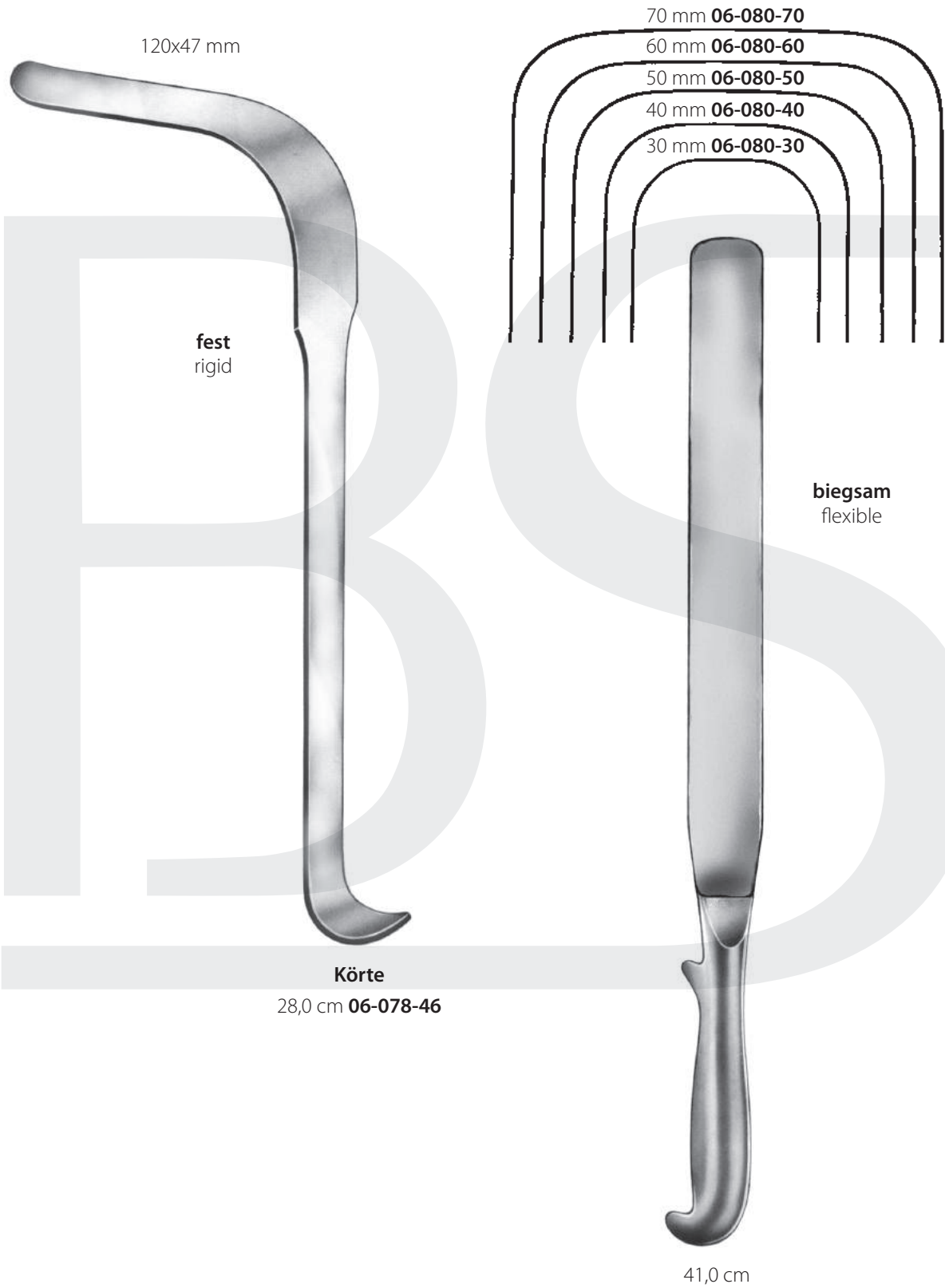

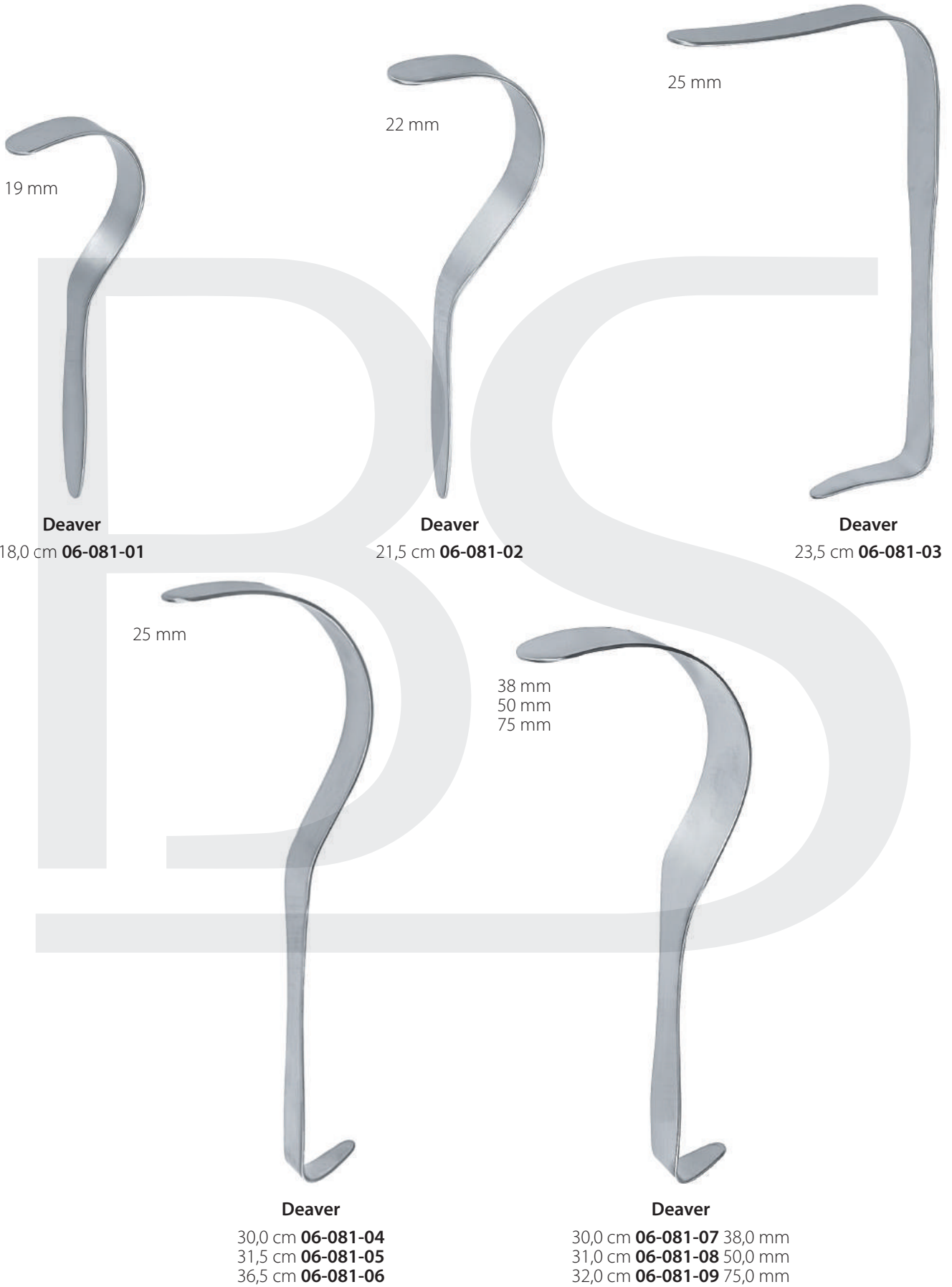

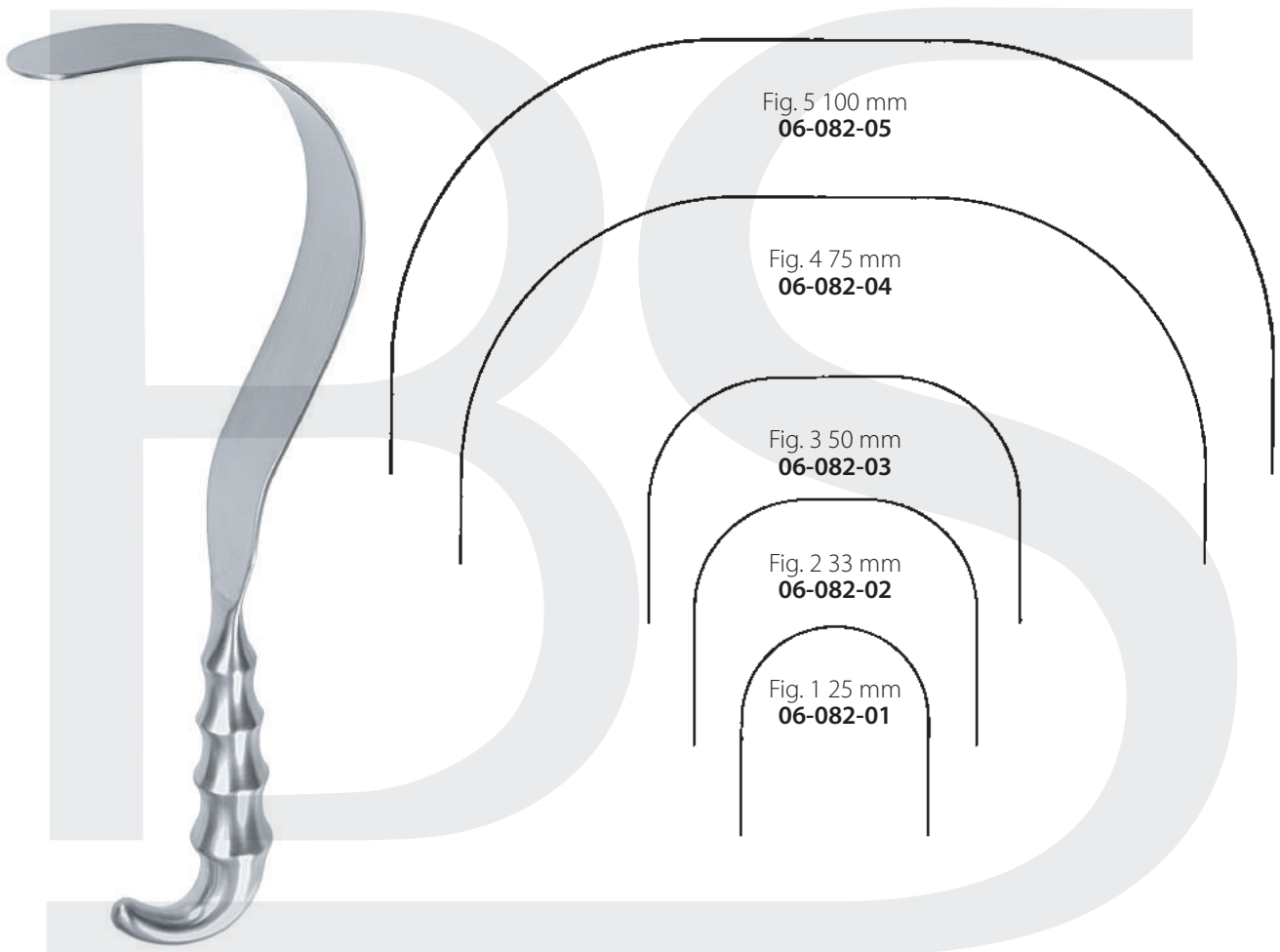

Fig. 5 100 mm
06-082-05

Fig. 4 75 mm
06-082-04

Fig. 3 50 mm
06-082-03

Fig. 2 33 mm
06-082-02

Fig. 1 25 mm
06-082-01

Deaver
31,0 cm

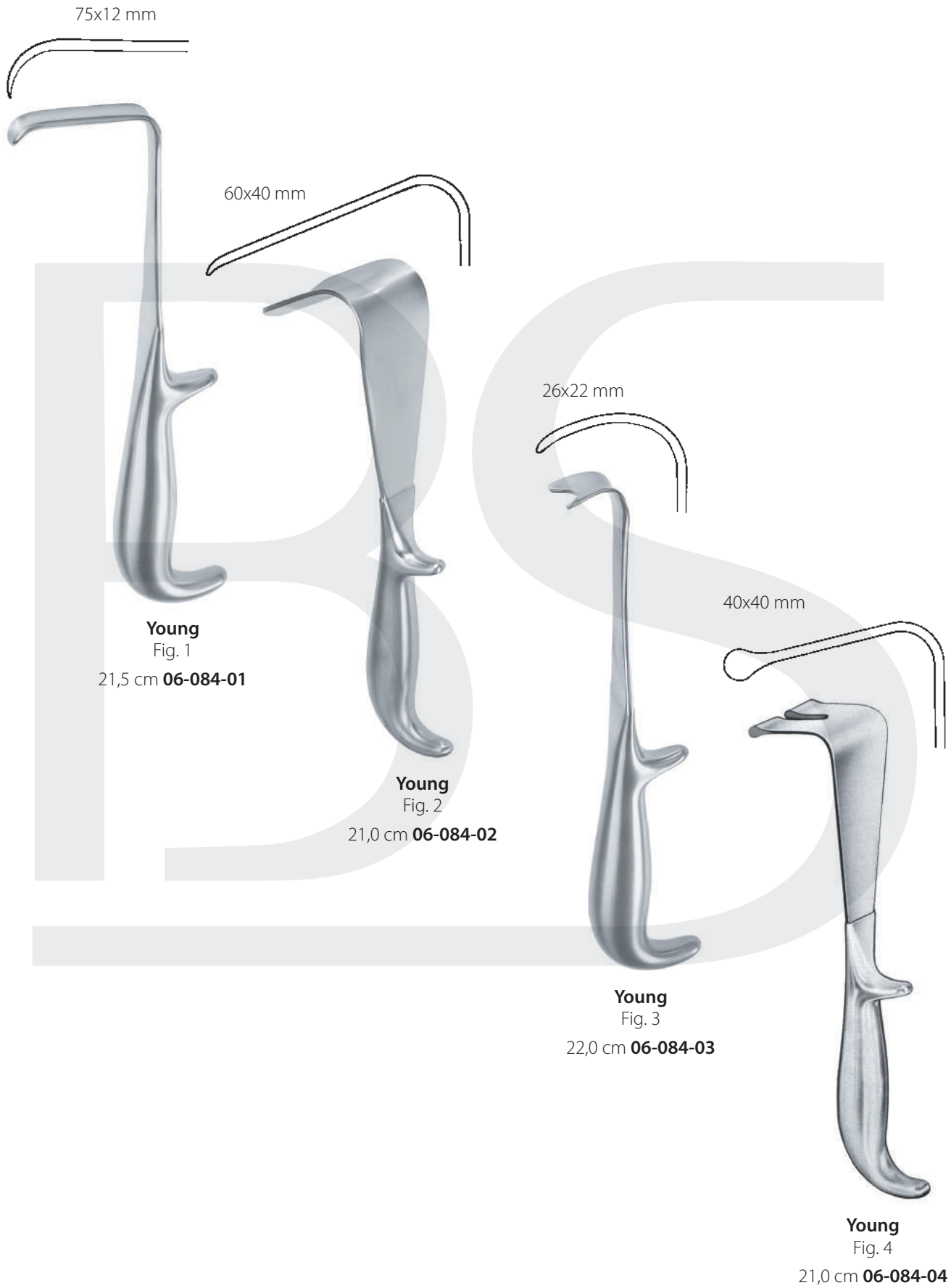

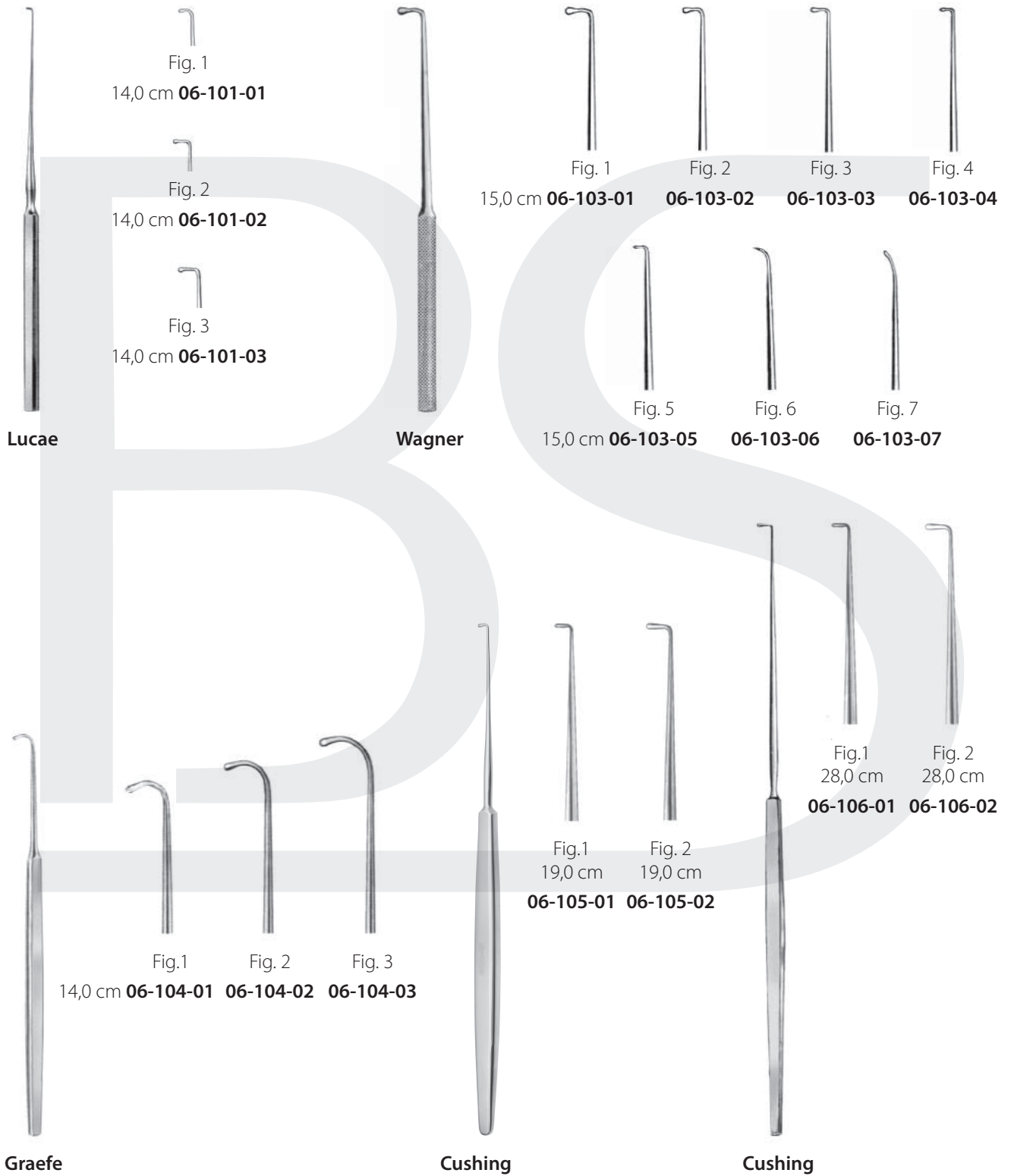



Crile
20,0 cm **06-107-01**



scharf/sharp
16,0 cm **06-108-01**
12,0 cm **06-108-02**



scharf/sharp
Fig. 1, 16 cm
06-110-01



scharf/sharp
Fig. 2, 16 cm
06-110-02



stumpf/blunt
16,0 cm **06-109-01**
12,0 cm **06-109-02**



scharf/sharp
Fig. 3, 16 cm
06-110-03



scharf/sharp
Fig. 4, 16 cm
06-110-04

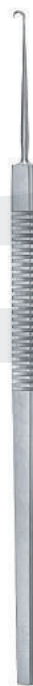

O'Conner
16,0 cm **06-111-01**



Guthrie
Fig. 1
06-112-01



Guthrie
Fig. 2
06-112-02



Wundhäkchen
16,0 cm **06-113-02**

Feine Hakchen
Hooks and Retractors, fine

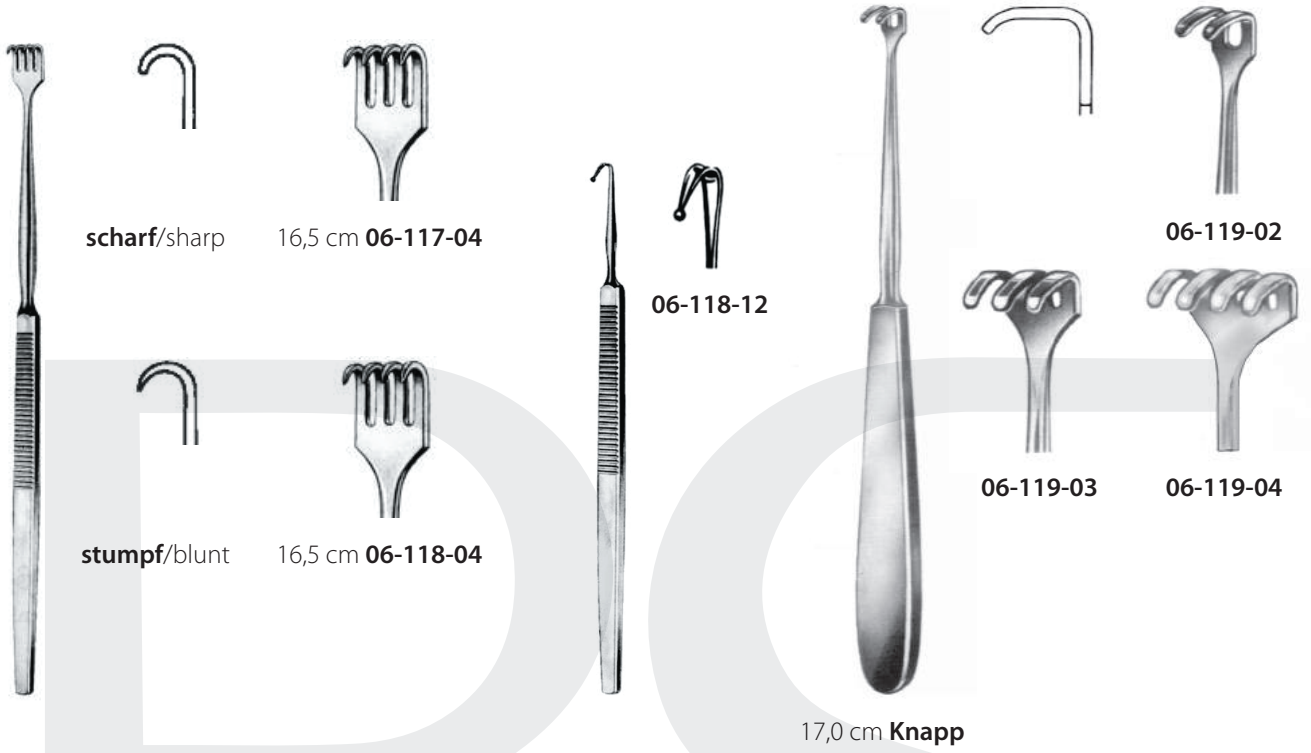

scharf/sharp 16,5 cm 06-117-04

06-118-12

06-119-02

stumpf/blunt 16,5 cm 06-118-04

06-119-03

06-119-04

17,0 cm Knapp

06

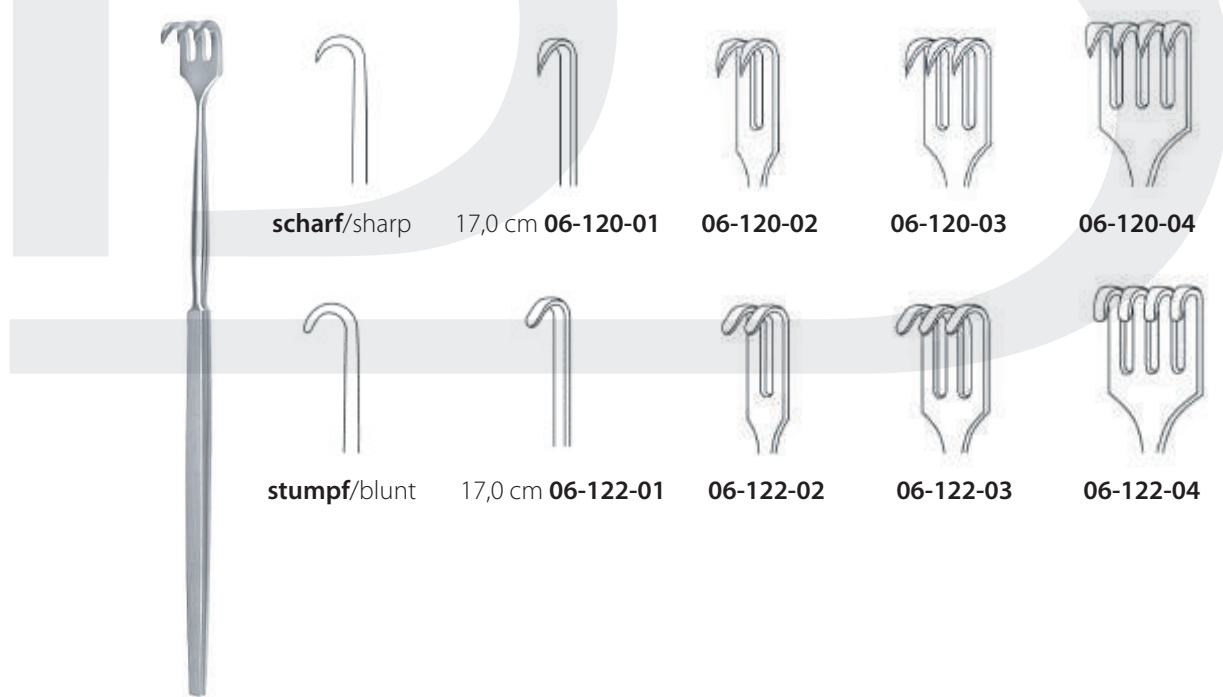

scharf/sharp 17,0 cm 06-120-01 06-120-02 06-120-03 06-120-04

stumpf/blunt 17,0 cm 06-122-01 06-122-02 06-122-03 06-122-04

Feines Hakchen - weite Biegung
fine hook - large curvature
Trachea Retractor



scharf/sharp

16,5 cm **06-124-01**

06-124-02

06-124-03

06-124-04



halbscharf/semi sharp

16,5 cm **06-125-01**

06-125-02

06-125-03

06-125-04



stumpf/blunt

16,5 cm **06-126-01**

06-126-02

06-126-03

06-126-04



Feines Häkchen - enge Biegung
fine hook - small curvature
Trachea Retractor



13,0 cm
16,0 cm



8,0 mm
06-127-08
06-128-08



10,0 mm
06-127-10
06-128-10



12,0 mm
06-127-12
06-128-12



13,0 cm
16,0 cm

14,0 mm
06-127-14
06-128-14



16,0 mm
06-127-16
06-128-16



18,0 mm
06-127-18
06-128-18

Desmarres

Feine Haken
Hooks and Retractors, fine



13,0 cm
16,0 cm

Desmarres



12,0 mm
06-129-12
06-130-12



14,0 mm
06-129-14
06-130-14



16,0 mm
06-129-16
06-130-16



18,0 mm
06-129-18
06-130-18



06-131-03

Simon
22,0 cm **06-131-02**



König, 18,0 cm



13x13 mm
06-132-01



12x16 mm
06-132-02



Cushing

20,0 cm
24,0 cm



8,0 mm
06-133-08
06-134-08



10,0 mm
06-133-10
06-134-10



12,0 mm
06-133-12
06-134-12



14,0 mm
06-133-14
06-134-14



16,0 mm
06-133-16
06-134-16



18,0 mm
06-133-18
06-134-18



Cushing-Kocher
18,0 cm 06-135-10

Gil-Vernet, 24,0 cm

Senn-Green, 15,0 cm

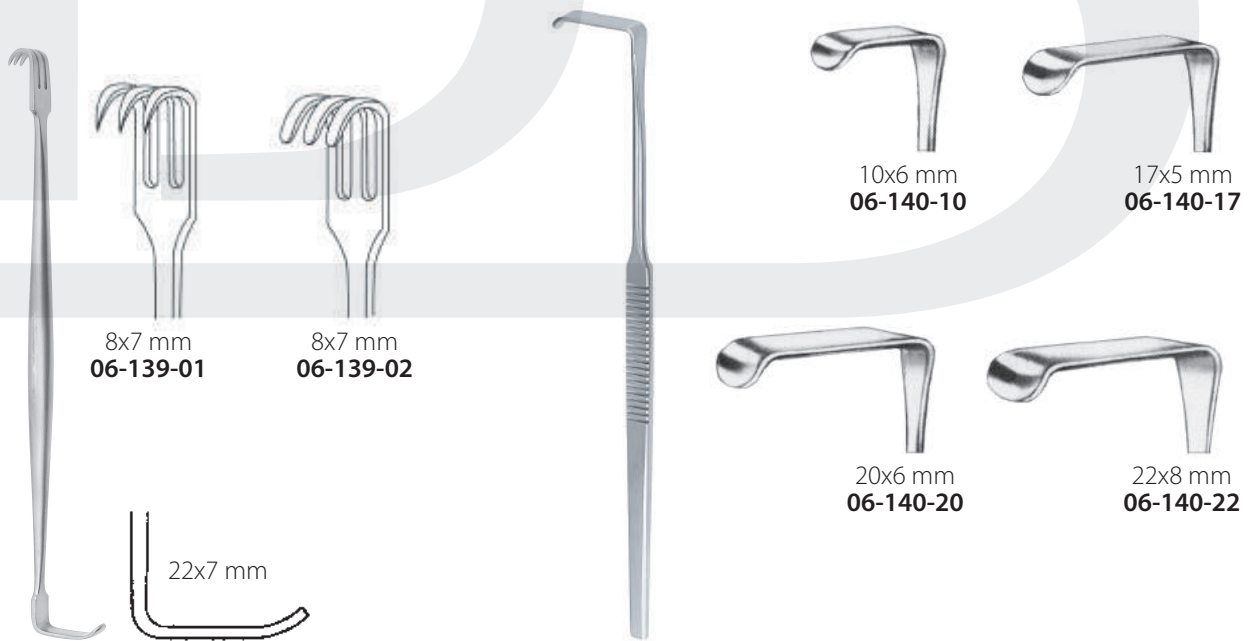

Senn-Miller, 14,0 cm

Langenbeck, 16,0 cm

Feine Hakchen
Hooks and Retractors, fine

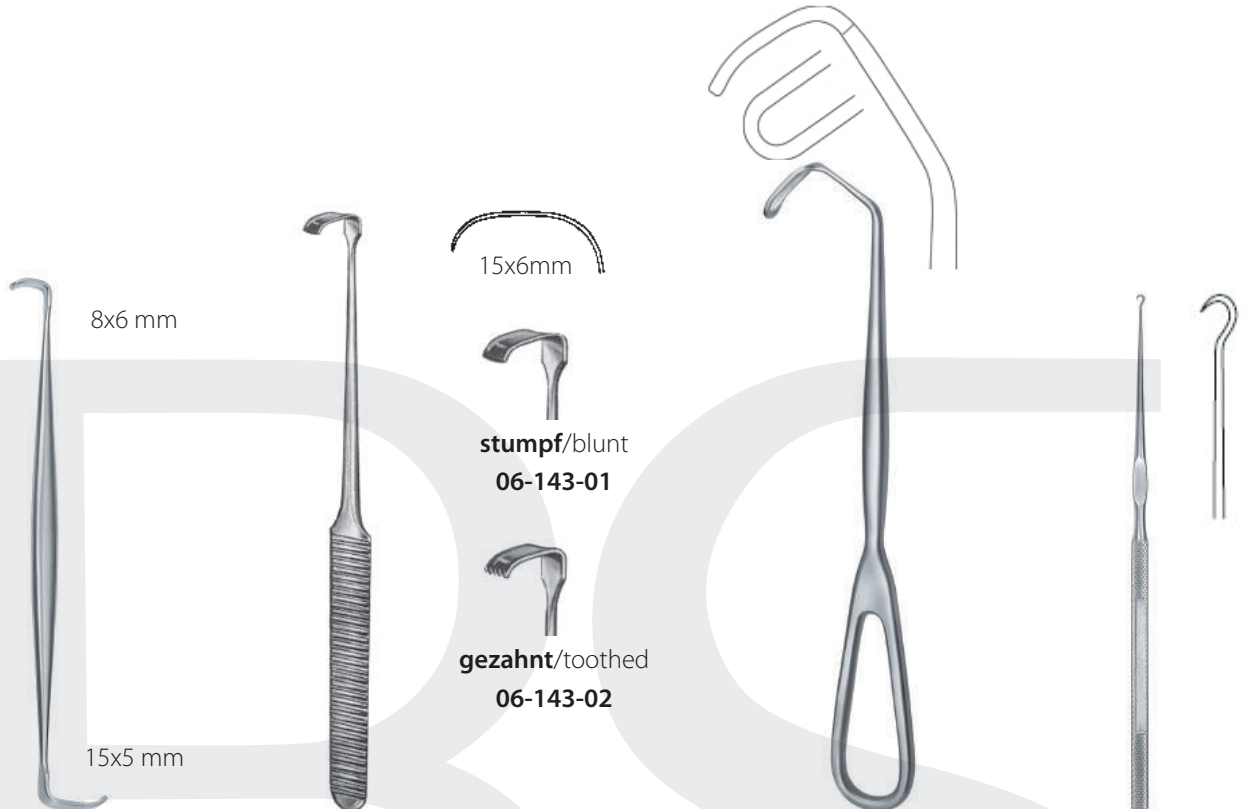

Ragnell-Davis
15,0 cm 06-142-14

Strandell-Stille, 18,0 cm

Cushing
20,0 cm 06-144-20

Kilner
16,0 cm 06-150-16

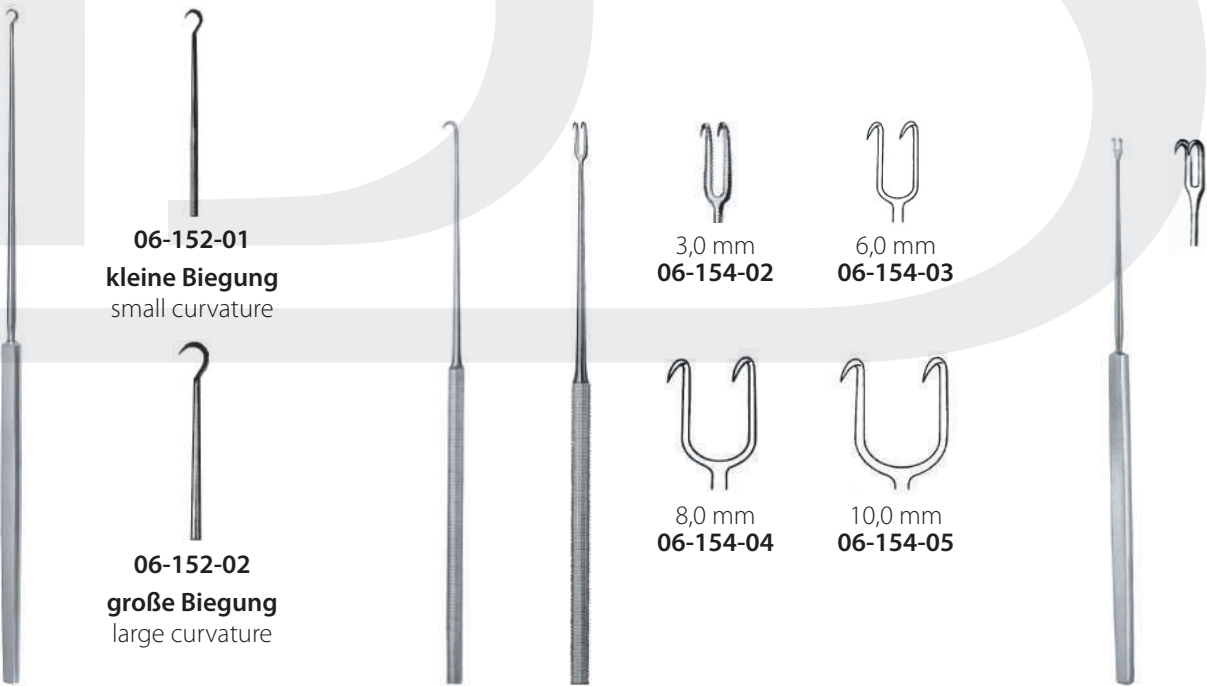

Gillies, 18,0 cm

Joseph
06-154-01, 16,0 cm

Freer
15,0 cm 06-156-15



Cushing, 25,0 cm



11x14 mm
06-160-14



17x18 mm
06-160-18



15x22 mm
06-160-22



Paul
12,0 cm **06-162-12**



Cushing, 25,0 cm



Fig.1
06-164-01



Fig.2
06-164-02



Fig.1 13x13 mm
06-170-01



Fig. 2 14x12 mm
06-170-02



Fig. 3 18x18 mm
06-170-03



Fig. 4 20x20 mm
06-170-04



Fig. 5 22x18 mm
06-170-05



Fig. 6 26x24 mm
06-170-06



Ross, 25,0 cm

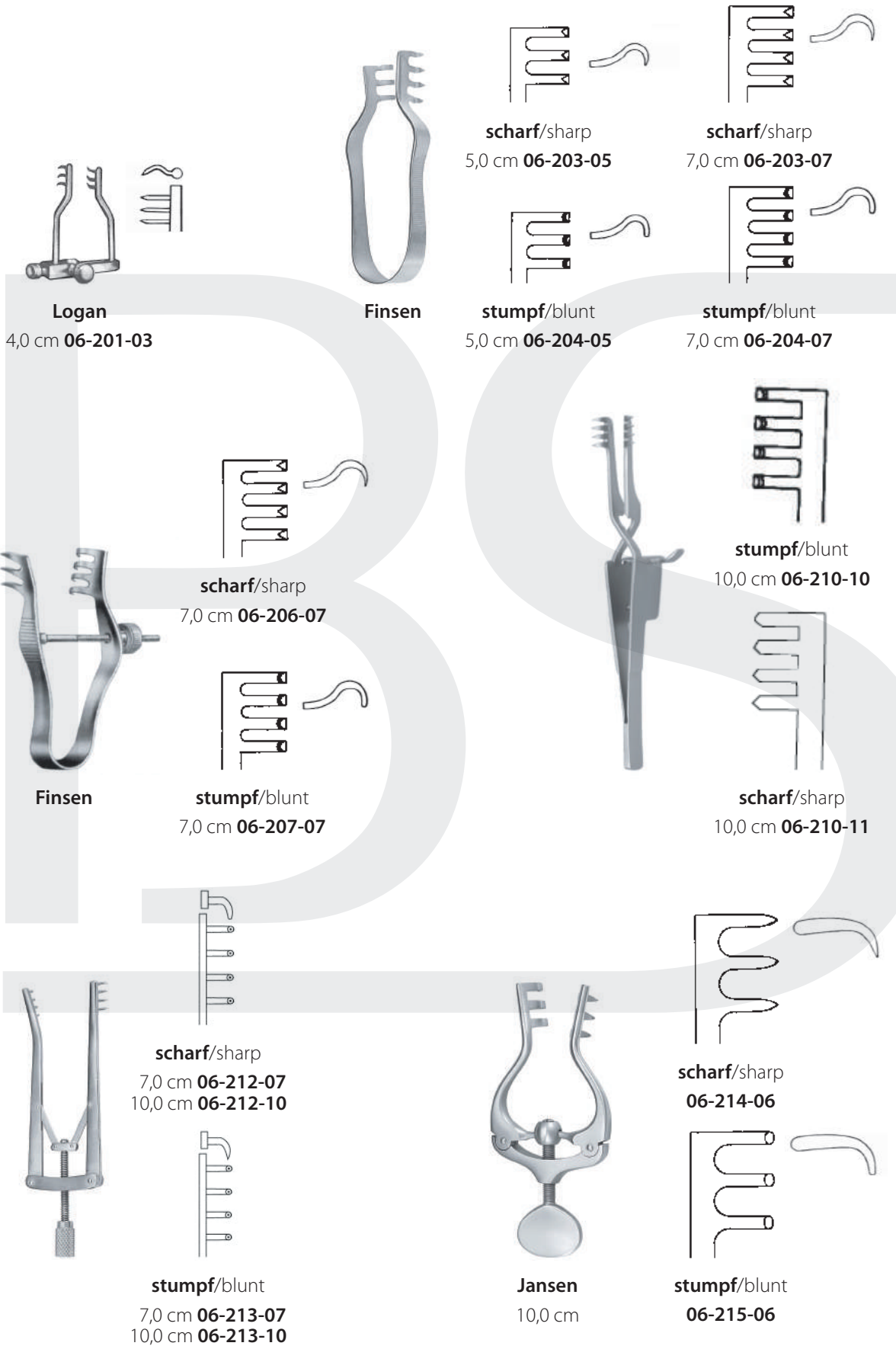

06



Scalp-Contour, 14,0 cm

scharf/sharp
06-216-14

stumpf/blunt
06-216-15

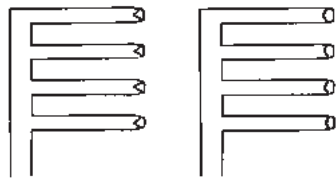

Weitlaner, 10,5 cm

scharf/sharp
06-217-10

stumpf/blunt
06-218-10

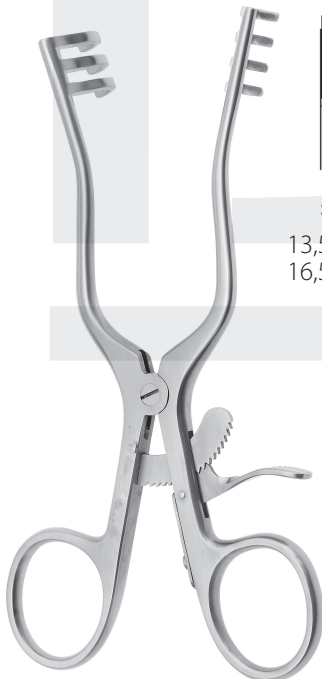
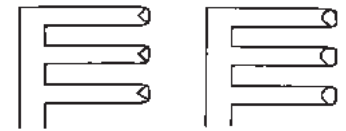

Weitlaner

scharf/sharp
13,5 cm **06-217-13**
16,5 cm **06-217-16**

stumpf/blunt
13,5 cm **06-218-13**
16,5 cm **06-218-16**

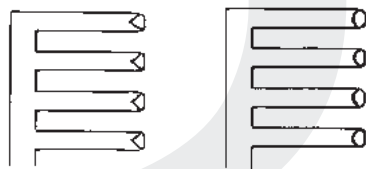



Weitlaner-Wullstein, 13,0 cm

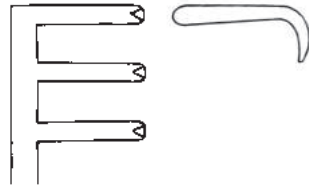

scharf/sharp

- 10,0 cm **06-600-11**
- 13,0 cm **06-600-13**
- 16,0 cm **06-600-16**

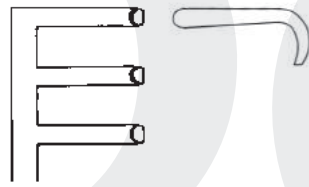

stumpf/blunt

- 10,0 cm **06-601-11**
- 13,0 cm **06-601-13**
- 16,0 cm **06-601-16**



Mollison, 15,0 cm

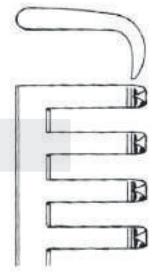

scharf/sharp

06-221-15



Plester, 13,0 cm

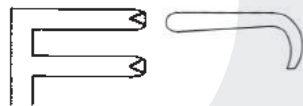

scharf/sharp

- 10,0 cm **06-610-11**
- 13,0 cm **06-610-13**
- 16,0 cm **06-610-16**

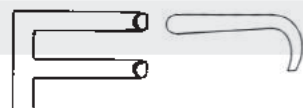

stumpf/blunt

- 10,0 cm **06-611-11**
- 13,0 cm **06-611-13**
- 16,0 cm **06-611-16**



Plester, 11,0 cm
links stumpf/left blunt
11,0 cm **06-614-11**
13,0 cm **06-614-13**

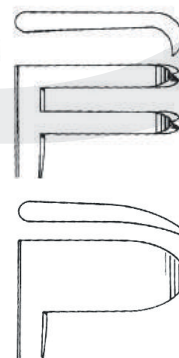

Plester, 11,0 cm
rechts stumpf
right blunt

- 11,0 cm **06-615-11**
- 13,0 cm **06-615-13**



Milligan, 13,0 cm

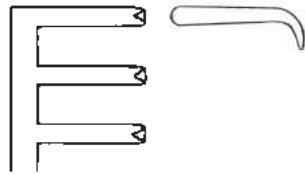

scharf/sharp
06-227-13

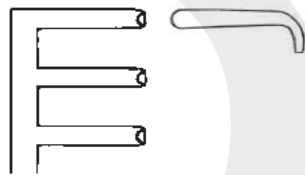

stumpf/blunt
06-228-13



Weitlaner-Baby
13,0 cm 06-230-13

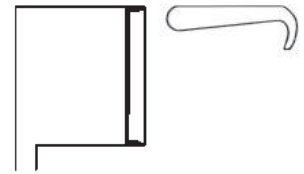

stumpf/blunt



Tübinger Modell
16,5 cm 06-231-16

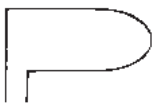

Henley, 16,5 cm

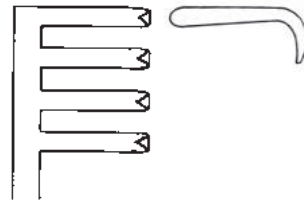

scharf/sharp
06-234-00

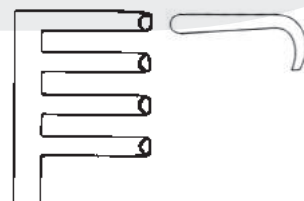

stumpf/blunt
06-235-00

16x19 mm 06-236-19
16x25 mm 06-236-25
16x32 mm 06-236-32

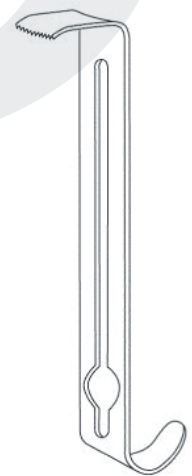

Henley Mittelvalve



Anderson-Adson, 20,0 cm

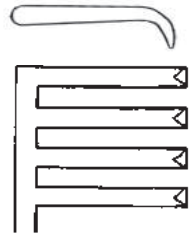

scharf/sharp
06-241-20

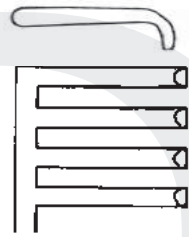

stumpf/blunt
06-242-20



Weitlaner

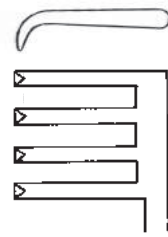

3:4 scharf/sharp
20,0 cm 06-243-20
24,0 cm 06-243-24

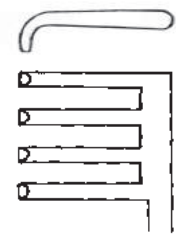

3:4 stumpf/blunt
20,0 cm 06-244-20
24,0 cm 06-244-24

5:6 scharf/sharp
29,0 cm 06-243-26

5:6 stumpf/blunt
29,0 cm 06-244-26



Adson, 26,5 cm

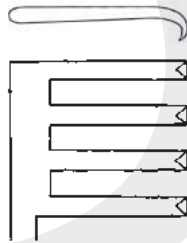

3:4 scharf/sharp
06-246-07

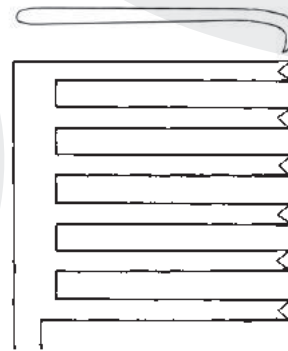

5:6 scharf/sharp
06-246-12

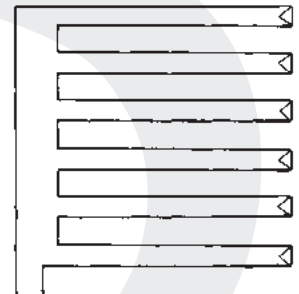

6:6 scharf/sharp
06-246-26

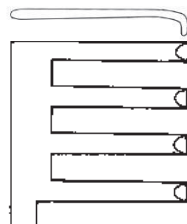

3:4 stumpf/blunt
06-247-07

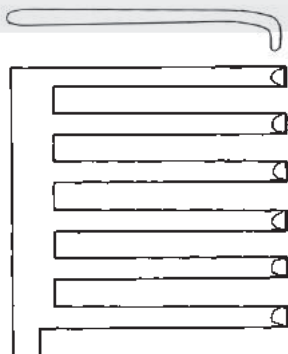

5:6 stumpf/blunt
06-247-12

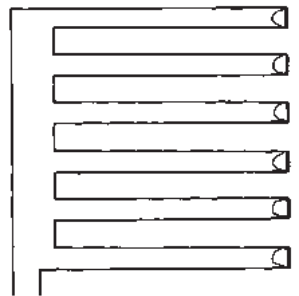

6:6 stumpf/blunt
06-247-26



4:5 stumpf/blunt
06-247-21

Travers 20,0 cm



4:5 stumpf/blunt
06-247-22

Norfolk-Norwich 22,0 cm



Gelpi-Loktite
13,0 cm 06-248-13



Gelpi-Loktite
18,0 cm 06-248-18



Gelpi-Loktite
18,0 cm 06-249-18



Adson

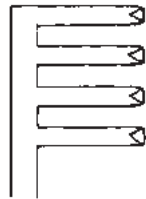

scharf/sharp

13,0 cm 06-252-13
16,0 cm 06-252-16

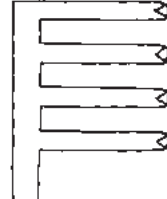

scharf/sharp

20,0 cm 06-252-20

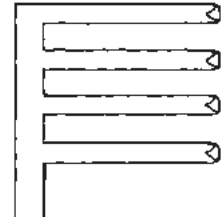

scharf/sharp

24,5 cm 06-252-26

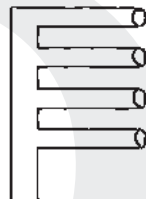

stumpf/blunt

13,0 cm 06-253-13
16,0 cm 06-253-16

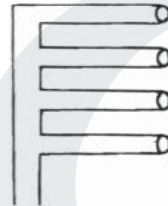

stumpf/blunt

20,0 cm 06-253-20

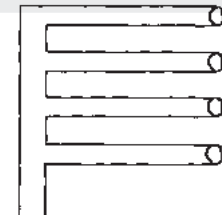

stumpf/blunt

24,5 cm 06-253-26

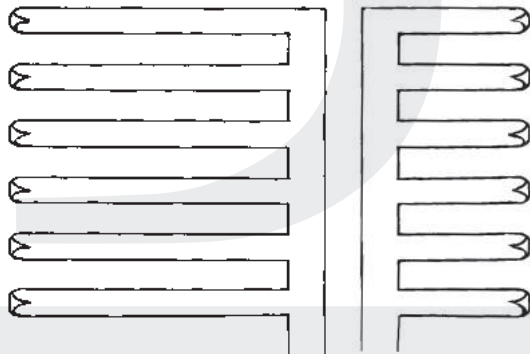

scharf/sharp
links lang/left long
rechts lang/right long

06-254-01
06-254-02



Adson, 27,0 cm

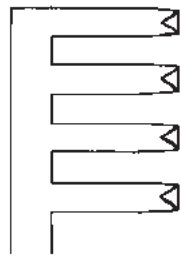

scharf/sharp
06-255-31

stumpf/blunt
06-256-31



Beckmann, 31,0 cm

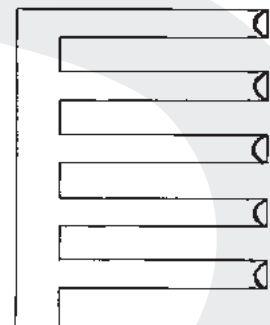

scharf/sharp
06-257-32

stumpf/blunt
06-258-32



Beckmann-Adson, 32,0 cm



Beckmann-Adson, 31,0 cm

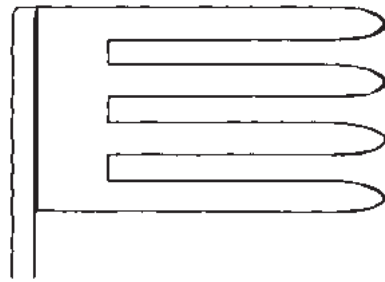

scharf/sharp
06-259-01

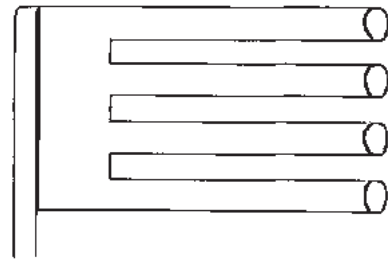

stumpf/blunt
06-259-02

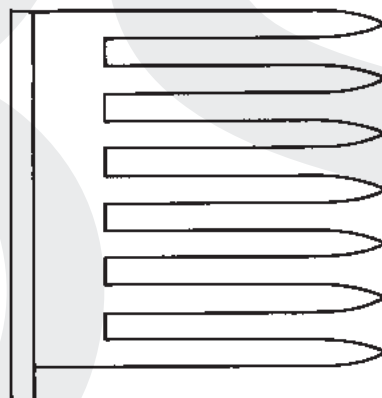

scharf/sharp
06-261-32



Beckmann-Eaton, 32,0 cm

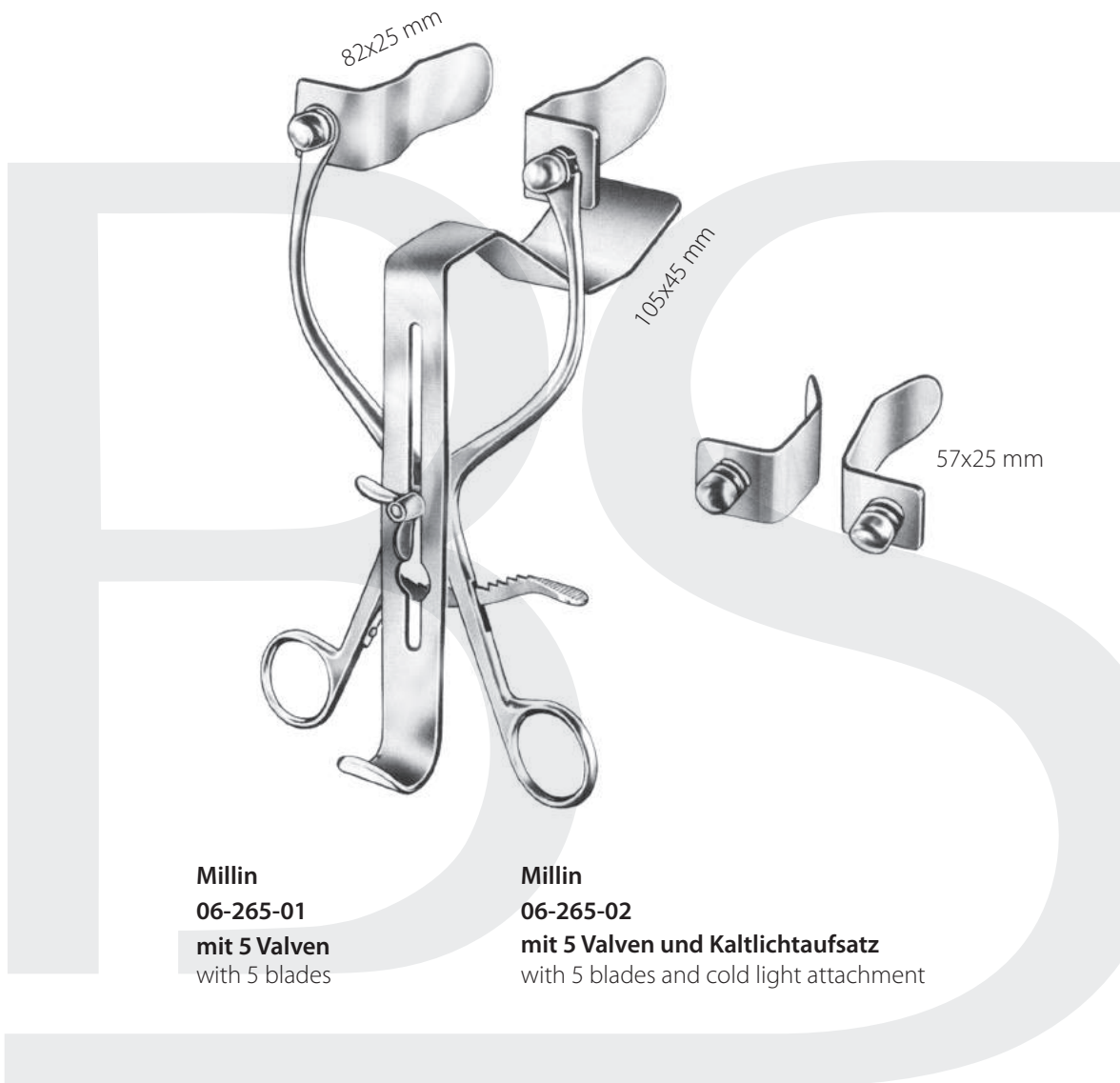

Millin
06-265-01
mit 5 Valven
with 5 blades

Millin
06-265-02
mit 5 Valven und Kaltlichtaufsatz
with 5 blades and cold light attachment

Sperrer allein
Retractor, only

06-265-10

Valven (Paar)
Blades (pair)

06-265-11 57x25 mm
06-265-12 82x25 mm

Mittelvalve
Center blades

06-265-13 105x45 mm

Bauchdeckenhalter
Abdominal Retractors



Baby-Collin 18,0 cm
06-267-00
mit 2 Paar Valven
with 2 pairs of blades



Collin 22,0 cm
06-268-00
mit 1 Paar Valven
with 1 pair of blades

Sperrer allein 06-267-01
Retractor, only

Valven (Paar) 06-267-02 23x44
Blades (pair) 06-267-03 30x44

Sperrer allein 06-268-01
Retractor, only

Valven (Paar) 06-268-02 32x62 mm
Blades (pair)

Mittelvalve 06-270-09
Center Blades

06-269-01 ca. 120 mm
06-270-02 ca. 160 mm



Collin

Sperrer komplett
Retractor complete

06-269-00

06-270-00

06-271-00

Sperrer allein
Retractor, only

06-269-01

06-270-02

06-270-02

Valven (Paar)
Blades (pair)

06-268-02
32x62 mm

06-268-02
38x80 mm

06-270-05
38x100 mm

Mittelvalve
Center blades

06-269-02
55x55 mm

06-269-03
55x65 mm

06-270-06
55x65 mm

Seiten- und Mittelvalve
Lateral and center blades

Seitenvalven
Lateral blades

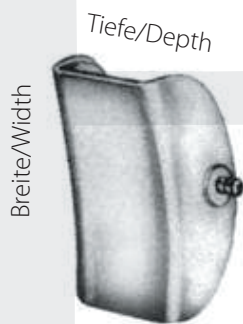

Mittelvalve
Center blades

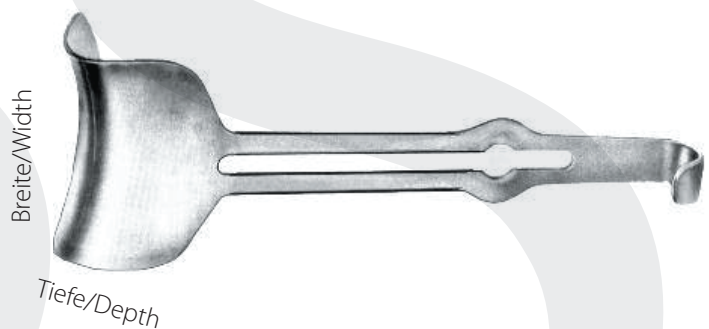

Tiefe x Breite
depth x width

Paar
pair

Tiefe x Breite
depth x width

23 x 44 mm	06-267-02
30 x 44 mm	06-267-03
32 x 62 mm	06-268-02
38 x 80 mm	06-270-04
38 x 100 mm	06-270-05
50 x 58 mm	06-270-07
62 x 80 mm	06-270-08

38 x 55 mm	06-269-02
55 x 55 mm	06-269-03
55 x 65 mm	06-270-06
62 x 70 mm	06-270-09

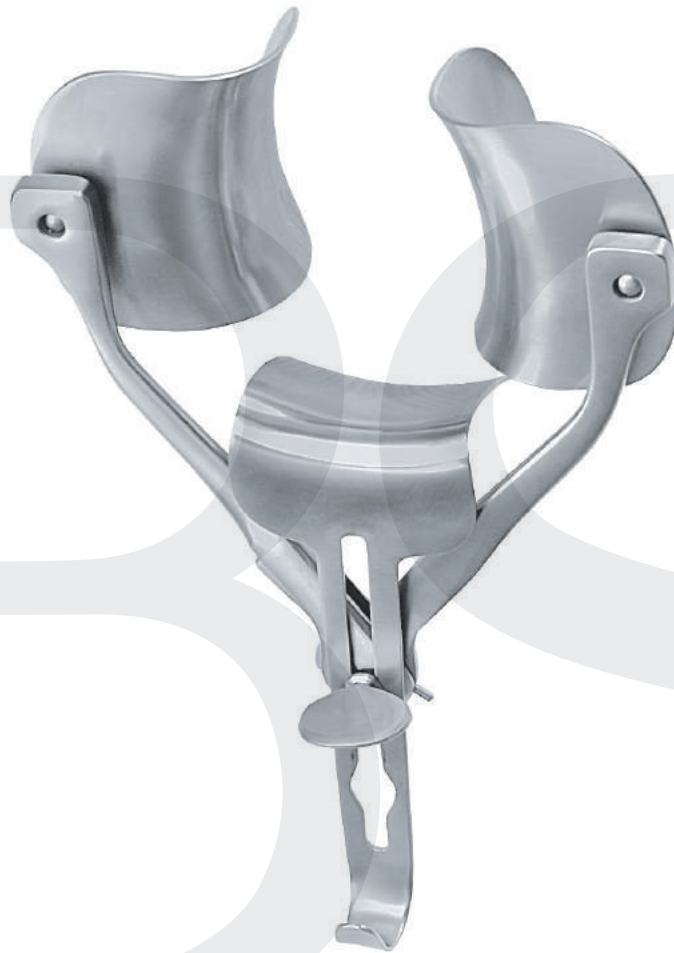

Ricard

Sperrer, komplett Retractor, complete	06-272-00	06-273-00
Sperrer, allein Retractor, only	06-272-01	06-272-01
Valven, Paar Blades, pair	06-272-02 60 x 80 mm	06-272-03 72x85 mm
Mittelvalve Center blades	06-272-04 55 x 70 mm	06-272-05 80 x 90 mm

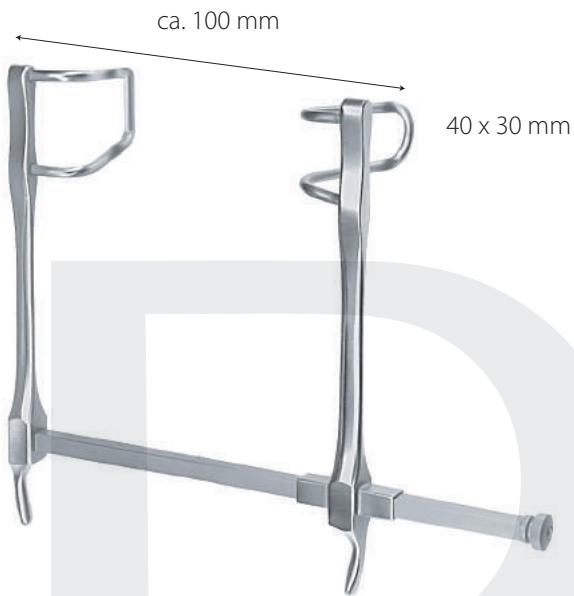

Gosset
Fig.1
06-274-10

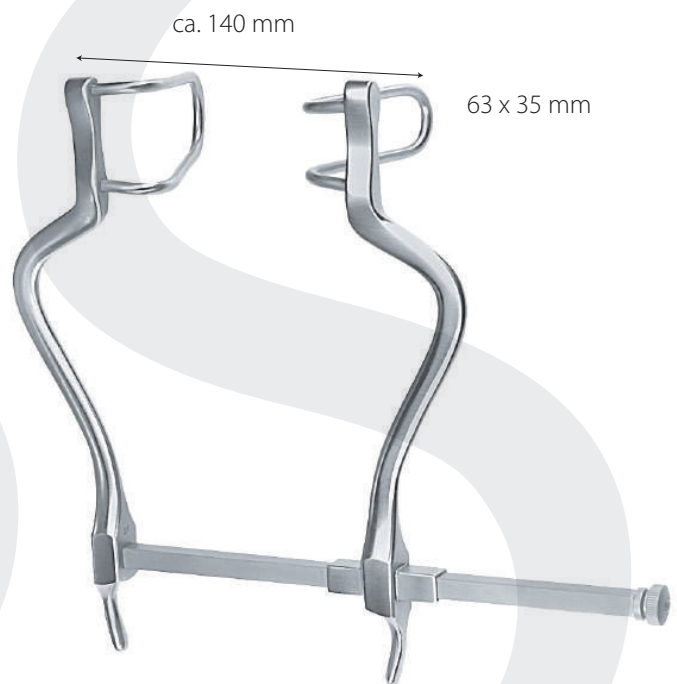

Gosset
Fig.2
06-274-14

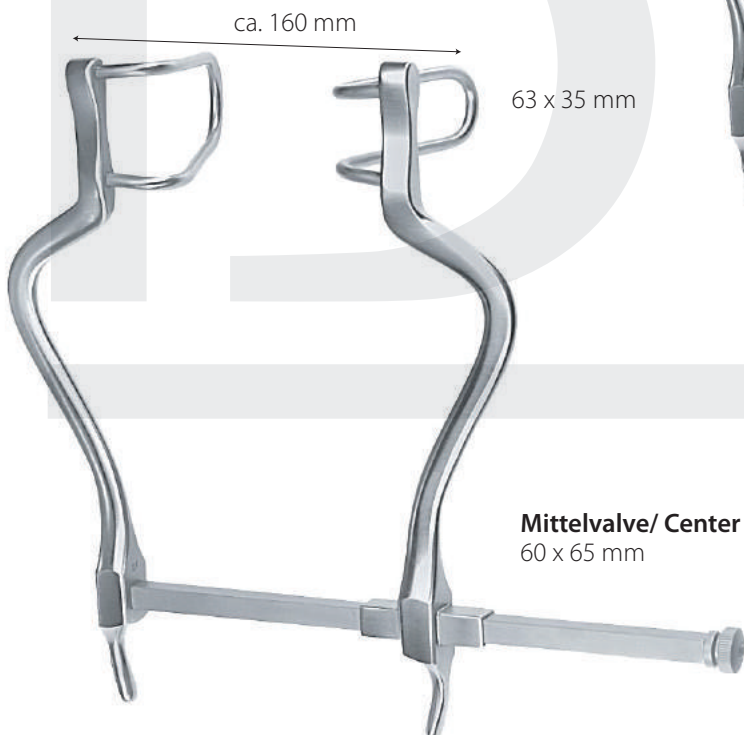

Gosset
Fig.3
06-275-16



Balfour-Baby
06-276-00
komplett
complete

Seitenvalven/Lateral blades:
27 mm **tief/deep**

Mittelvalve/ Center blade
24 x 20
06-280-04

06-277-18, Fig. 1

Seitenvalven/Lateral blades:
65 mm **tief/deep**

Mittelvalve/ Center blade
45x80 mm
06-280-01

06-277-20, Fig. 2

Seitenvalven/Lateral blades:
100 mm **tief/deep**

Mittelvalve/ Center blade
102x60 mm
06-280-03

06-277-25, Fig. 3

Seitenvalven/Lateral blades:
100 mm **tief/deep**

Mittelvalve/ Center blade
70x80 mm
06-280-02



Balfour

06-277-18 Fig. 1
06-277-20 Fig. 2
06-277-25 Fig. 3



Balfour
06-278-18

Seitenvalven/Lateral blades:
70 mm **tief**/deep

Mittelvalve/ Center blade
45x80 mm
06-280-01

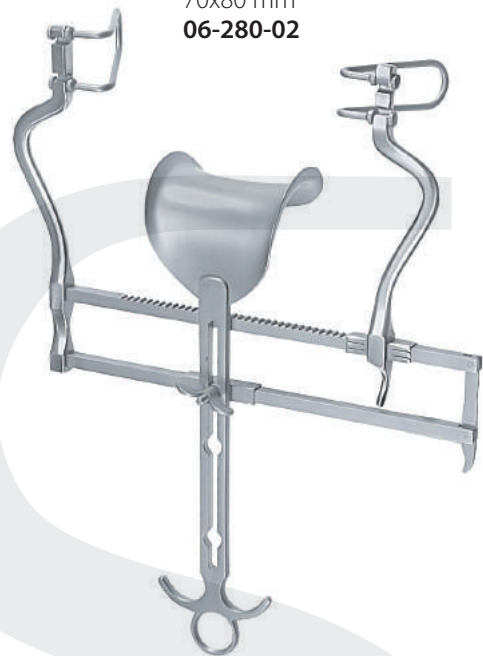

Balfour, US-Modell
06-279-00

Seitenvalven/Lateral blades:
70 mm **tief**/deep

Mittelvalve/ Center blade
70x80 mm
06-280-02



Balfour
06-280-01 45x80 mm
06-280-02 70x80 mm



Balfour
06-280-03 100x60 mm

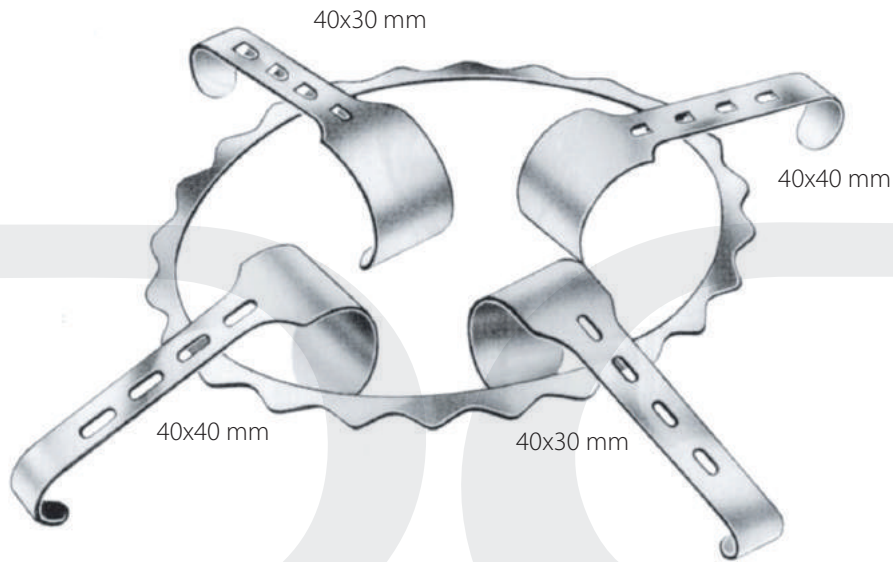

Dennis-Browne, komplett/complete
06-281-00

bestehend aus/
consisting of:

Rahmen Frame, only	06-281-15	175x150 mm
2 Rahmenhaken Blades	06-281-30	40x30 mm
2 Rahmenhaken Blades	06-281-40	40x40 mm

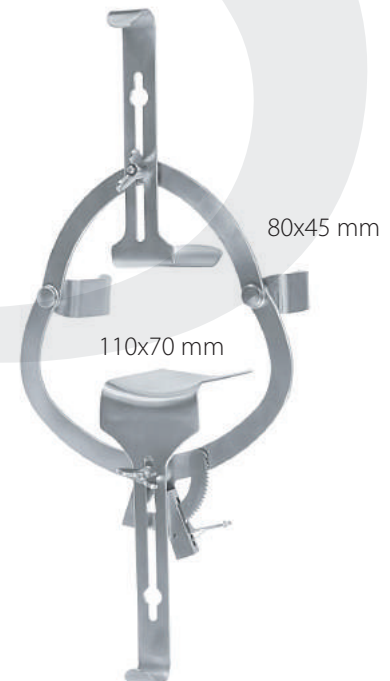

O'Sullivan-O'Connor
komplett/complete
06-282-00

bestehend aus/
consisting of:

Rahmen Frame, only	06-282-01	
2 Rahmenhaken Blades	06-282-02	80x45 mm
1 Rahmenhaken Blades	06-282-03	110x70 mm

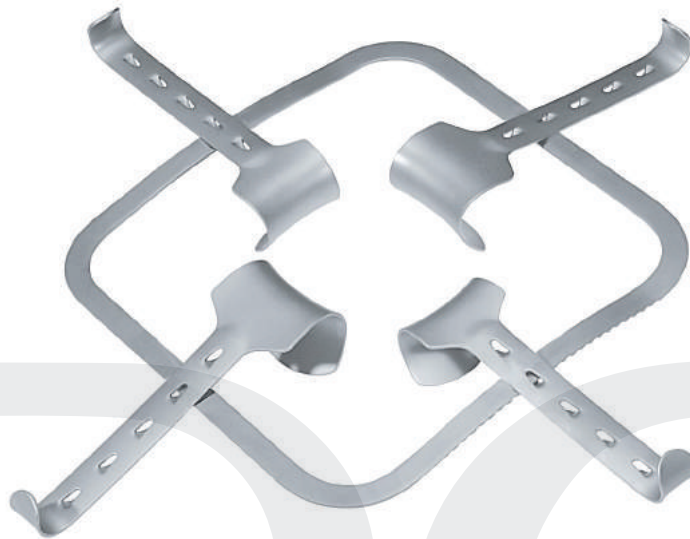

Kirschner, komplett/complete
06-283-00

bestehend aus/
consisting of:

- Rahmen** 06-283-24 240x240 mm
Frame, only
- 2 Rahmenhaken** 06-283-40 40x55 mm
Blades
- 2 Rahmenhaken** 06-283-50 50x65 mm
Blades

weitere Einzelteile/
other parts:

- Rahmen** 06-283-26 260x300 mm
Frame, only
- Rahmen** 06-283-36 260x360 mm
Frame, only
- 1 Rahmenhaken** 06-283-60 60x85 mm
Blades
- 06-283-78 78x65 mm
- 06-283-80 80x90 mm
- 06-283-98 98x50 mm
- 06-283-99 105x35 mm

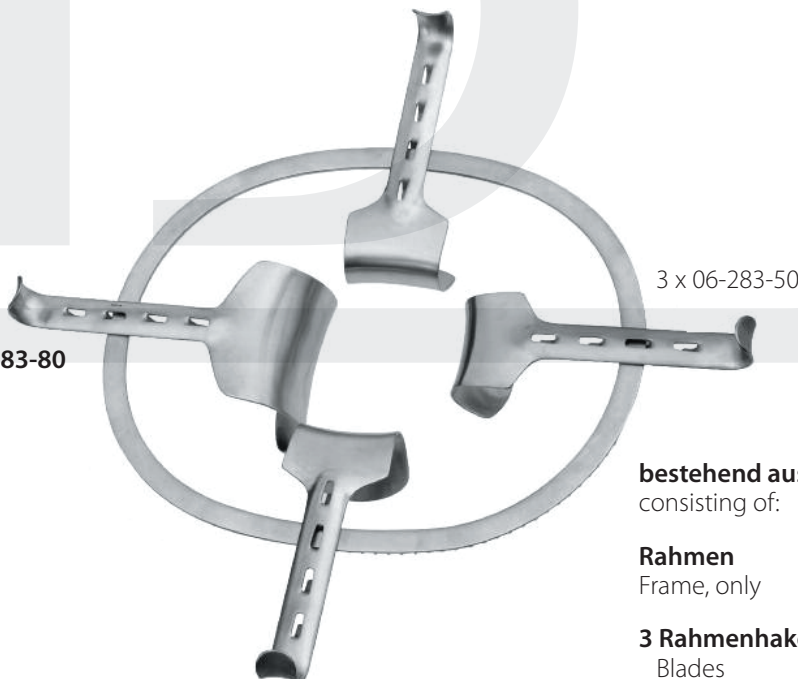

Kirschner, oval
komplett/complete
06-284-00

bestehend aus/
consisting of:

- Rahmen** 06-284-30 300x240 mm
Frame, only
- 3 Rahmenhaken** 06-283-50 50x65 mm
Blades
- je 1 Rahmenhaken** 06-283-80 80x90 mm
one blade each
- 06-283-98 98x50 mm
- 06-283-99 105x35 mm

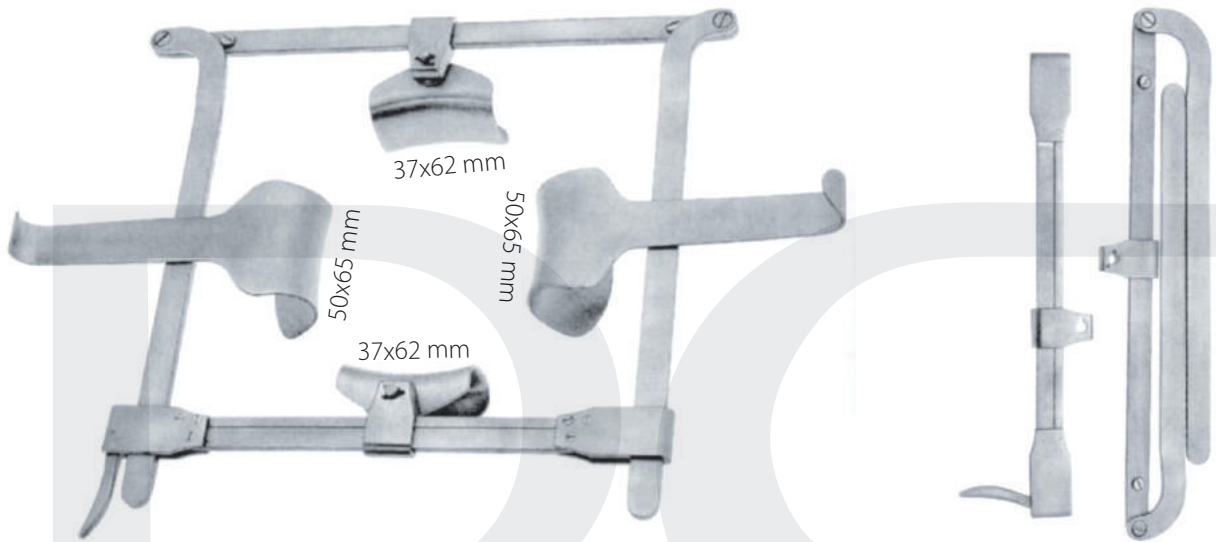

Franz
komplett/complete
06-286-00

bestehend aus/
consisting of:

Rahmen Frame, only	06-286-01	220x220 mm
2 Rahmenhaken Blades	06-268-02	37x62 mm
2 Rahmenhaken Blades	06-283-50	50x65 mm



Holzbach
06-295-00

Bauchdeckenhalter
Abdominal Retractors

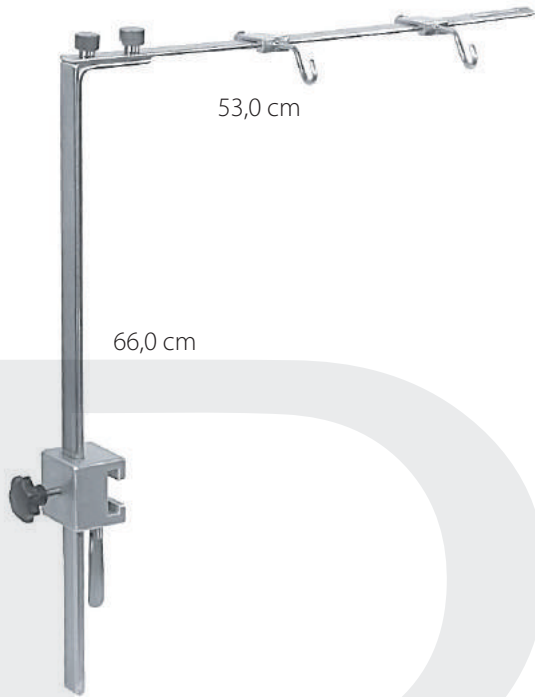

Rochard
06-300-01



Rochard
06-300-09 50x95 mm
06-300-10 50x105 mm
06-300-12 50x120 mm
06-300-13 50x135 mm
06-300-15 50x155 mm



Fixiervorrichtung
Fixation device
06-300-05
19,0 cm

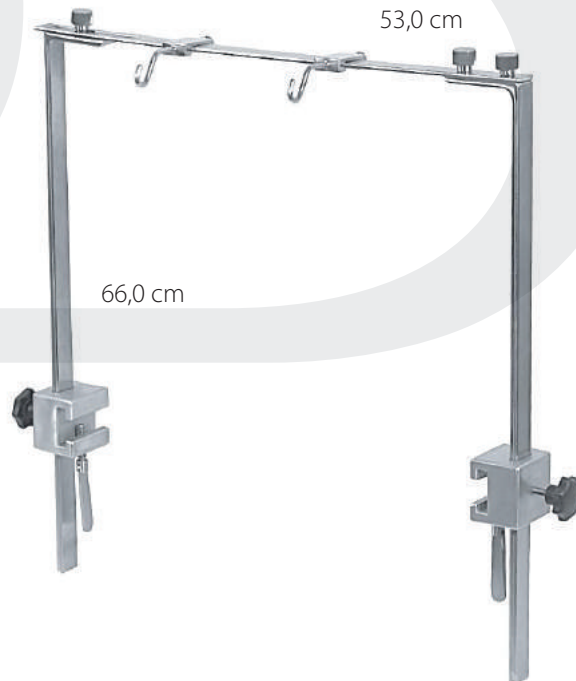

Rochard
06-300-02



Doyen
28,0 cm

- 55 x 95 mm **06-301-01**
- 55 x 105 mm **06-301-02**
- 55 x 115 mm **06-301-03**
- 55 x 125 mm **06-301-04**





06





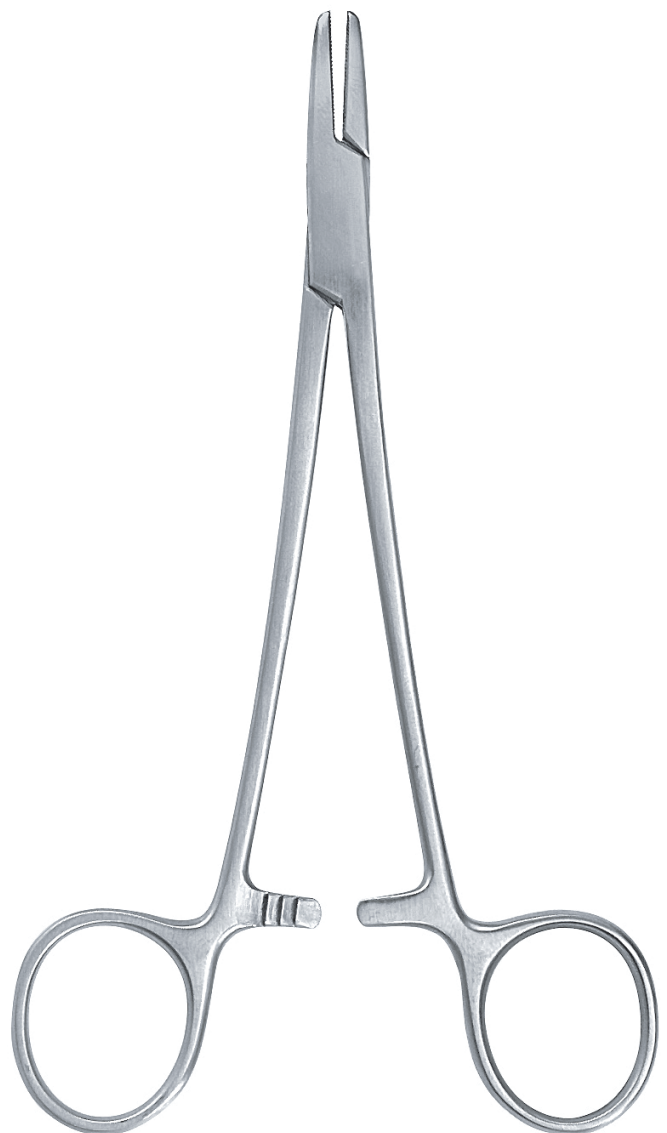



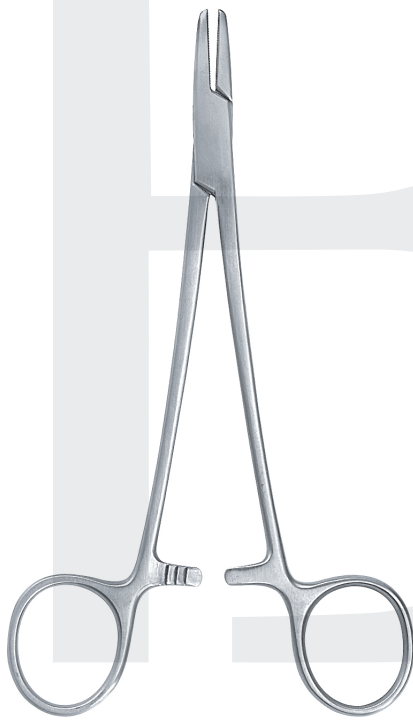



Kette mit Gewicht
Chain with weight
79cm 645g **06-301-79**

Nadelhalter, Nahtinstrumente
Needle Holders, Suture Instruments

07







					
	14,0 cm 07-002-14	16,0 cm 07-002-16	18,0 cm 07-002-18	20,0 cm 07-002-20	
					normal
	24,0 cm 07-002-24	26,0 cm 07-002-26	30,0 cm 07-002-30		
					kräftig heavy
	15,0 cm 07-003-15	17,0 cm 07-003-17	20,0 cm 07-003-20		
Mayo-Hegar					schlank delicate
	16,0 cm 07-004-16	18,0 cm 07-004-18	20,0 cm 07-004-20		

Nadelhalter
Needle Holders

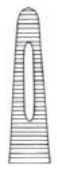

Adson
18,0 cm **07-008-18**



Crile-Murray

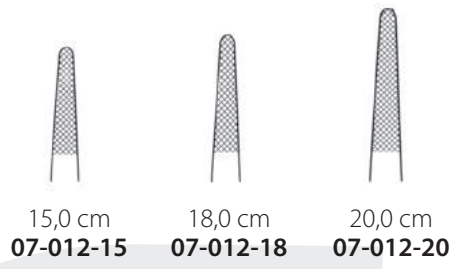

Crile-Wood
15,0 cm **07-014-15**
18,0 cm **07-014-18**



Sarot

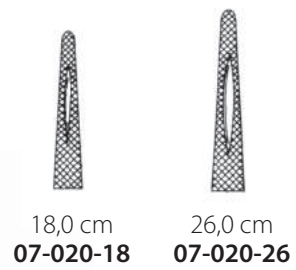

Hegar-Baumgartner
14,0 cm **07-022-14**



glatt/smooth



Neivert
13,0 cm **07-024-13**



Halsey, 13,0 cm

07-026-13

07-030-13



Webster
13,0 cm **07-028-13**



Derf
12,0 cm **07-032-12**



Derf, Converse
12,5 cm **07-034-12**



Collier
12,0 cm **07-036-12**



Heaney
21,0 cm **07-037-21**

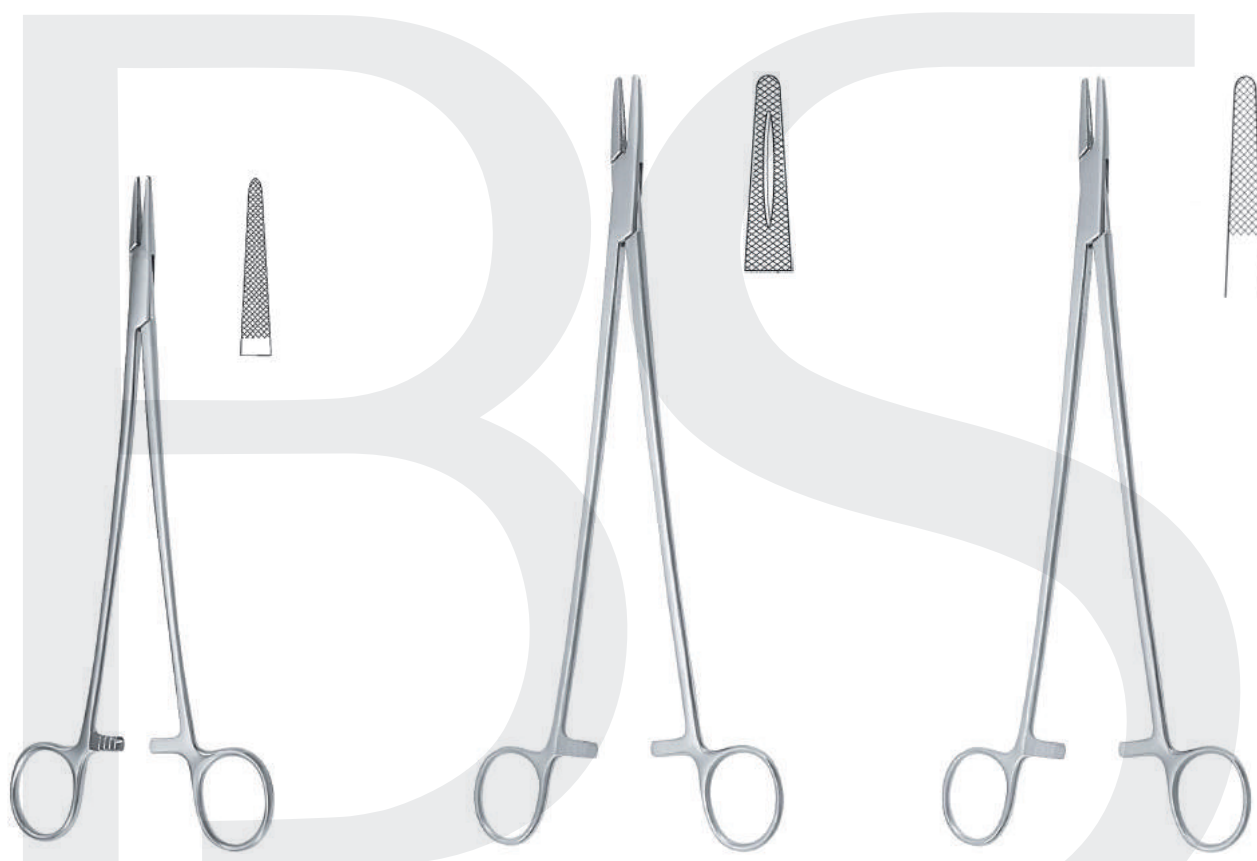

Jameson

23,5 cm **07-040-23**

Masson

27,0 cm **07-042-27**

Wangensteen

27,0 cm **07-044-27**

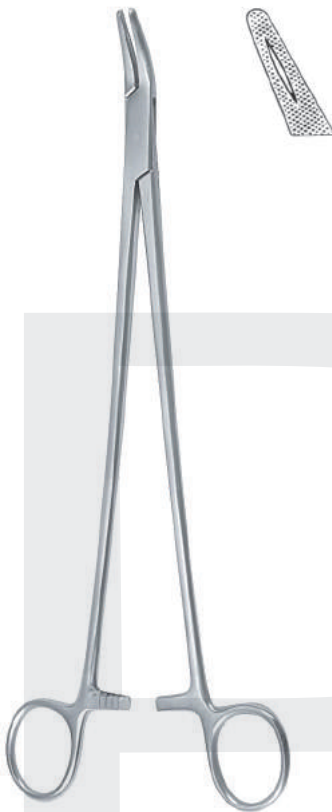

Finocchietto
27,0 cm **07-045-27**



Olsen-Hegar
14,0 cm **07-048-14**



Olsen-Hegar
18,0 cm **07-048-18**



Gillies
16,0 cm **07-049-16**

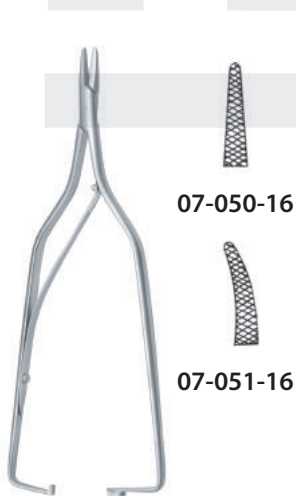

Arruga, 16,0 cm

07-050-16

07-051-16



Mathieu

14,0 cm
07-052-14



17,0 cm
07-052-17



20,0 cm
07-052-20



Mathieu

14,0 cm
07-054-14

17,0 cm
07-054-17

Mikro-Nadelhalter
Micro Needle Holders



Jacobson, 18,0 cm

mit Sperre
with catch
07-604-18 07-605-18

ohne Sperre
without catch
07-606-18 07-607-18



Mikro-Nadelhalter, 16,0 cm
Micro Needle Holder

mit Sperre
with catch
07-608-16 07-609-16

ohne Sperre
without catch
07-610-16 07-611-16



Castroviejo, 14,0 cm

mit Sperre
with catch
07-612-14 07-613-14

ohne Sperre
without catch
07-614-14 07-615-14

mit Sperre
with catch
07-612-13 07-613-13



Mikro-Nadelhalter, 18,0 cm
Micro Needle Holder

07-620-18

ohne Sperre
without catch

07-621-18



23,0 cm **07-630-23**
19,0 cm **07-632-19**
16,0 cm **07-634-16**

07-631-23
07-633-19
07-635-16

Mikro-Nadelhalter, bajonett
Micro Needle Holder, bayonet



22,5 cm **07-642-22**
20,0 cm **07-644-20**
16,5 cm **07-646-16**

07-643-22
07-645-20
07-647-16

Yasargil



Castroviejo 13,0 cm
07-682-14



07-306-12 **07-307-12**
mit Sperre
with catch

07-304-12 **07-305-12**
ohne Sperre
without catch

Mikro-Nadelhalter, 12,0 cm
Micro Needle Holder



07-328-15 **07-329-15**
mit Sperre
with catch

07-326-15 **07-327-15**
ohne Sperre
without catch

Mikro-Nadelhalter, 15,0 cm
Micro Needle Holder



07-328-18 **07-329-18**
mit Sperre
with catch

07-326-18 **07-327-18**
ohne Sperre
without catch

Mikro-Nadelhalter, 18,0 cm
Micro Needle Holder



Reverdin



Fig. 1

15,0 cm **07-701-15**
19,0 cm **07-701-19**



Fig. 2

07-703-15
07-703-19



Fig. 3

07-705-15
07-705-19



Fig. 4

07-707-15
07-707-19



Reverdin



Fig. 1

21,0 cm **07-701-21**
23,0 cm **07-701-23**



Fig. 2

07-703-21
07-703-23



Fig. 3

07-705-21
07-705-23



Fig. 4

07-707-21
07-707-23

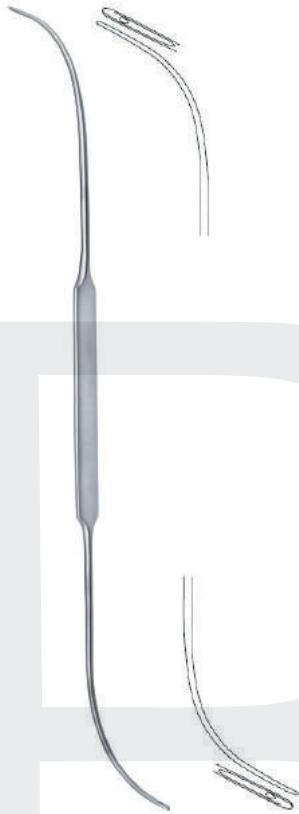

Schmieden-Dick
biegsam/flexible
30,0 cm **07-711-32**



Schmieden
24,0 cm **07-713-21**



biegsam/flexible
20,0 cm **07-715-20**



Cooper
19,0 cm **07-717-19**

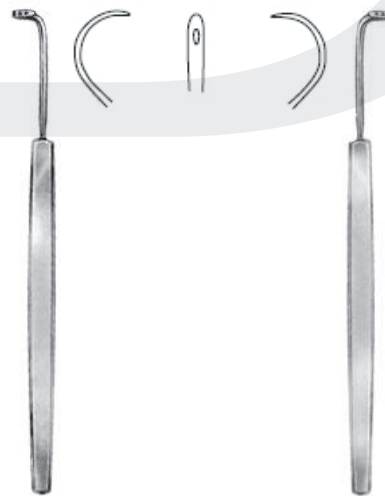

Kronecker
13,0 cm **07-721-13**

Kronecker
13,0 cm **07-723-13**

links gebogen - für rechte Hand
curved to left for the right hand

rechts gebogen - für linke Hand
curved to right for the left hand

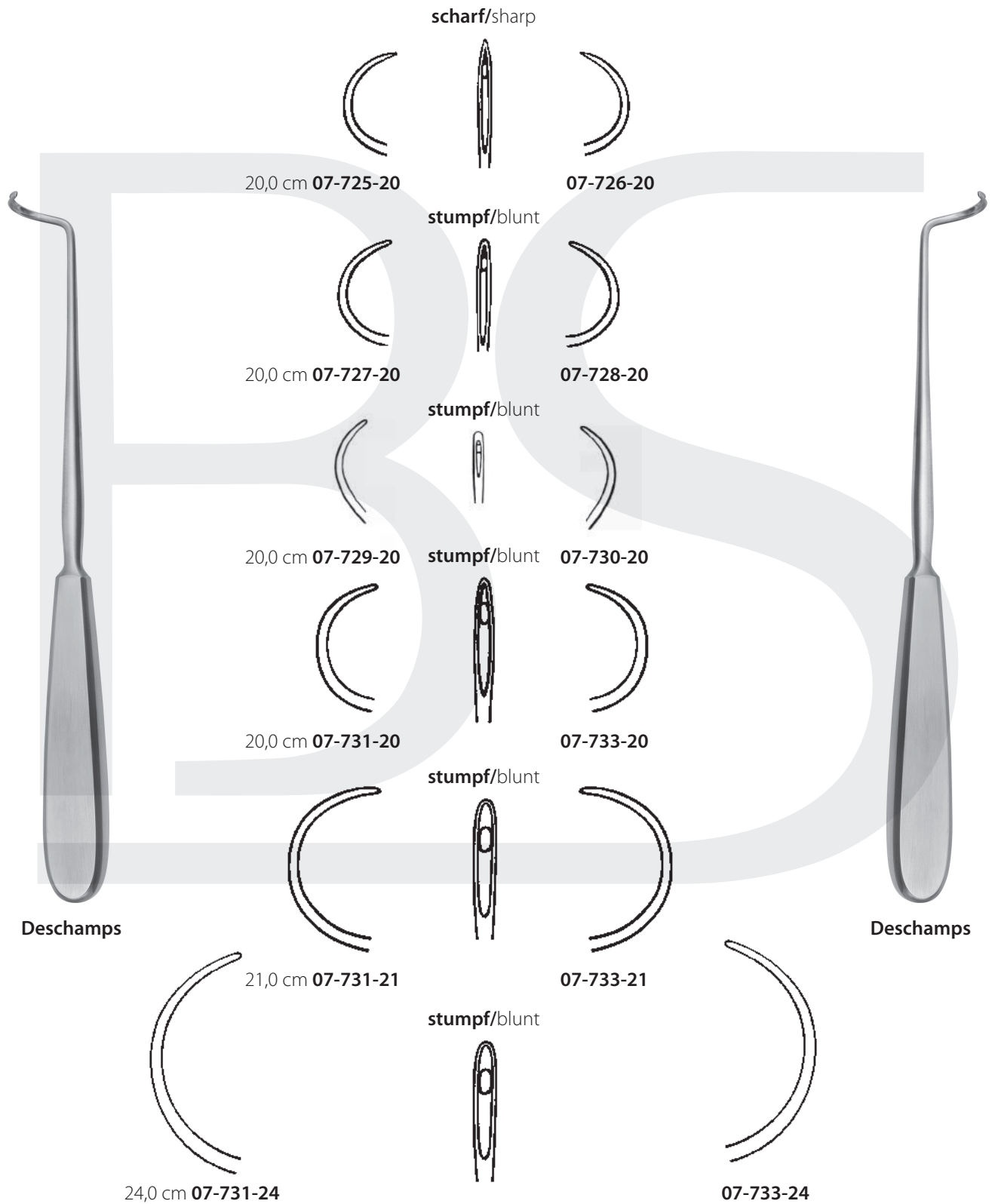

07

links gebogen - für rechte Hand
curved to left for the right hand

rechts gebogen - für linke Hand
curved to right for the left hand

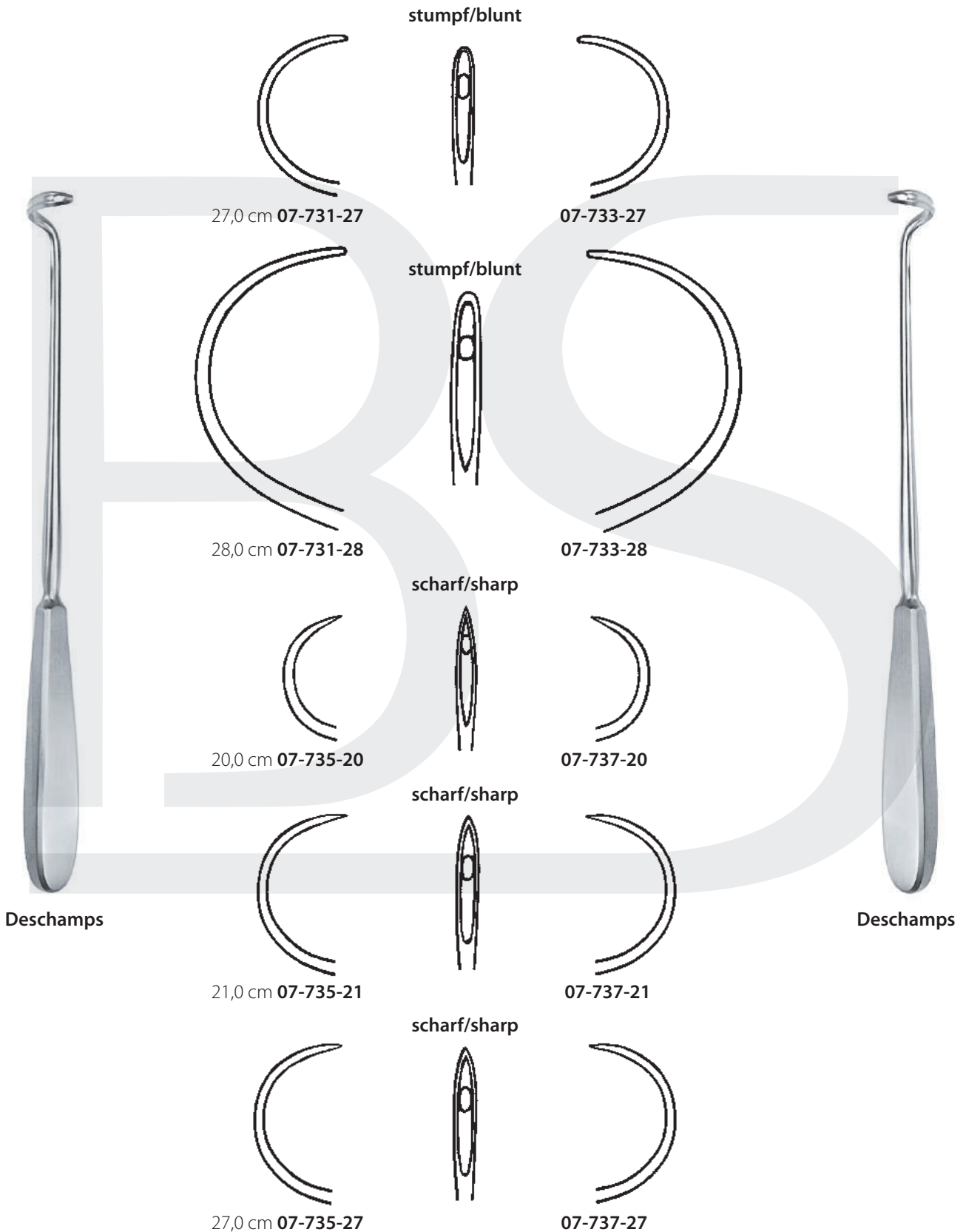

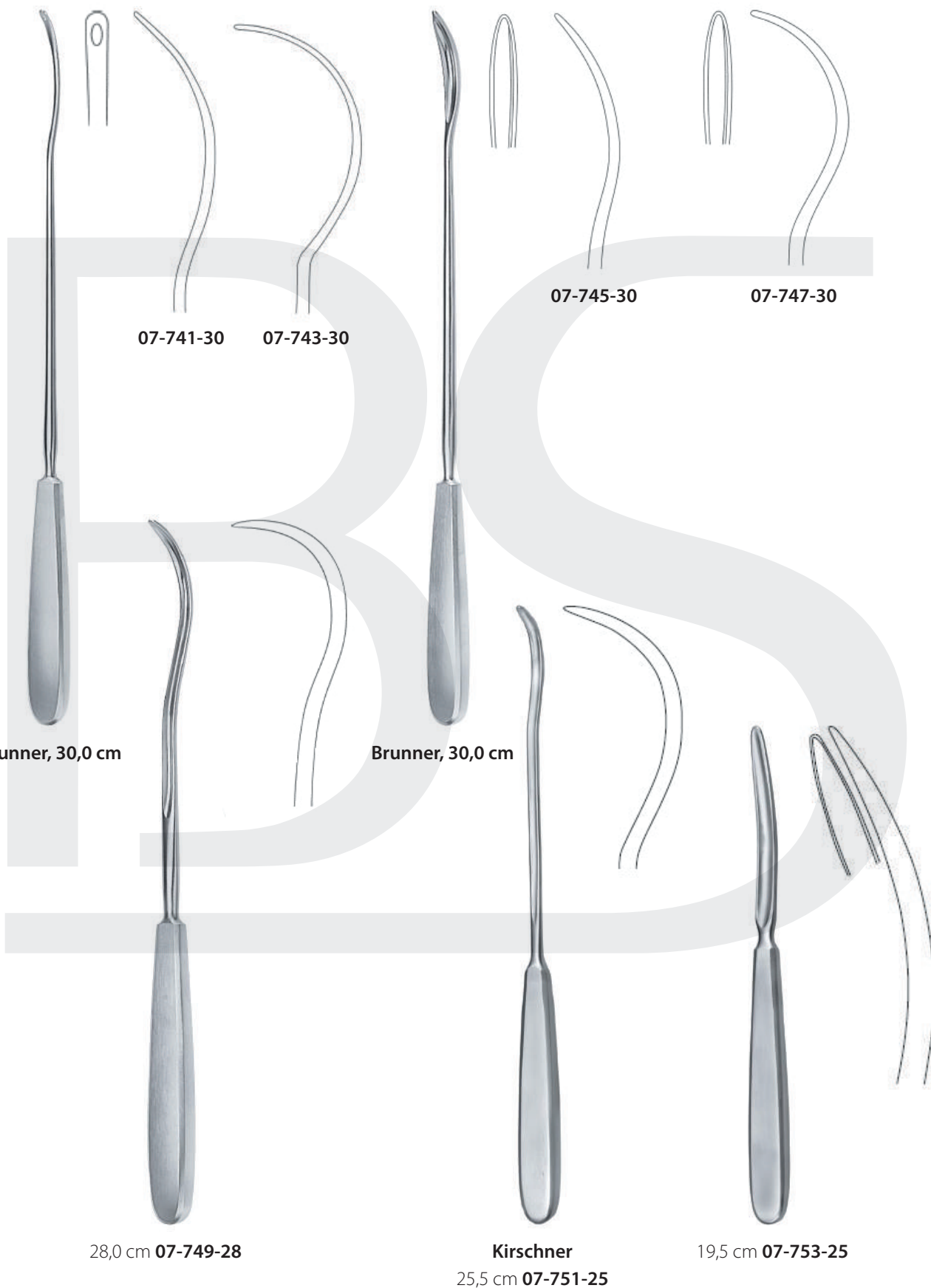

07



Brunner
18,0 cm **07-755-18**



Kirschner
aus Kunststoff, sterilisierbar
of plastic material, can be sterilized
27,0 cm **07-757-27**



aus Kunststoff, sterilisierbar
of plastic material, can be sterilized
19,0 cm **07-758-19**



aus Kunststoff, sterilisierbar
of plastic material, can be sterilized
18,5 cm **07-759-19**



Schmieden
19,0 cm **07-761-19**



Schmieden
19,0 cm **07-763-19**



3 mm
König
19,0 cm **07-765-19**



5 mm
König
19,0 cm **07-767-19**



7 mm
König
19,0 cm **07-769-19**



Payr

22,0 cm **07-770-22**



Payr

22,0 cm **07-771-22**



aus Kunststoff, sterilisierbar

of plastic material, can be sterilized

24,0 cm **07-772-24**



Young-Millin

20,0 cm **07-790-20**



Fig. 1

Ersatznadel

spare needle

07-790-51



Fig. 2

Ersatznadel

spare needle

07-790-52



Fig. 3

Ersatznadel

spare needle

07-790-53



Modell Wien

Fadenfänger

Ligature Catcher

23,0 cm **07-792-23**



Fadengabel

Ligatur Adjuster

23,0 cm **07-794-23**



Michel
12,5 cm **07-907-12**



Michel
13,0 cm **07-909-13**



Michel
12,0 cm **07-910-12**



Wachenfeldt
12,0 cm **07-914-12**



Hegenbarth
12,0 cm **07-916-12**



Childe
18,0 cm **07-922-18**



Collin
13,5 cm **07-932-13**



Richter-Heath
13,5 cm **07-933-13**

TC-Nadelhalter
TC Needle Holders

08



BS-Nadelhalter sind durch die verschiedenen Einlageplättchen auf die jeweiligen Modelle und deren Verwendung abgestimmt.

Due to the different types of inserts, BS needle holders differ according to the model and purpose for which they are intended.

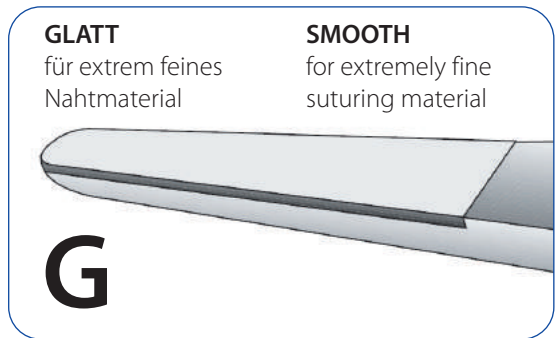
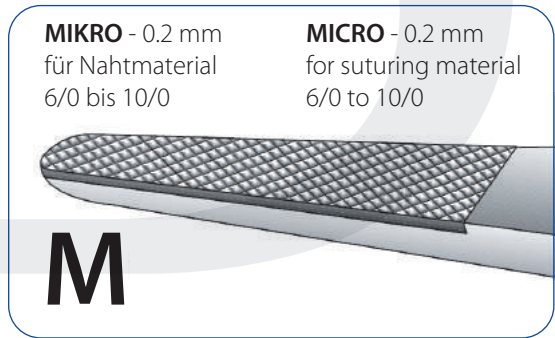
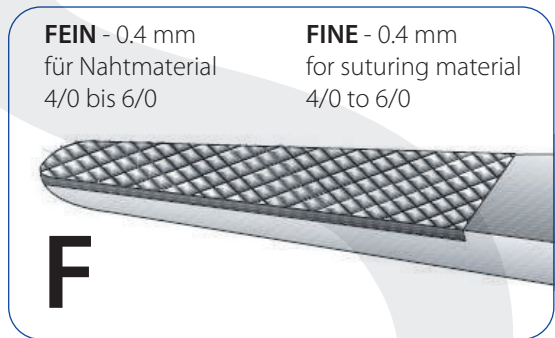
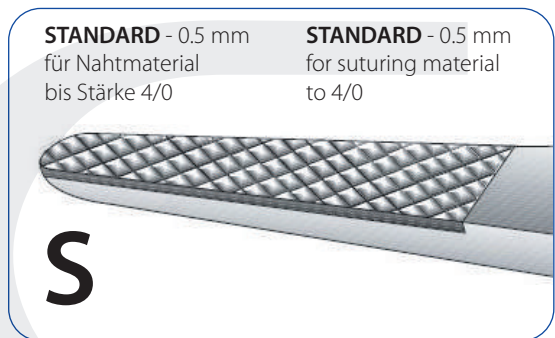
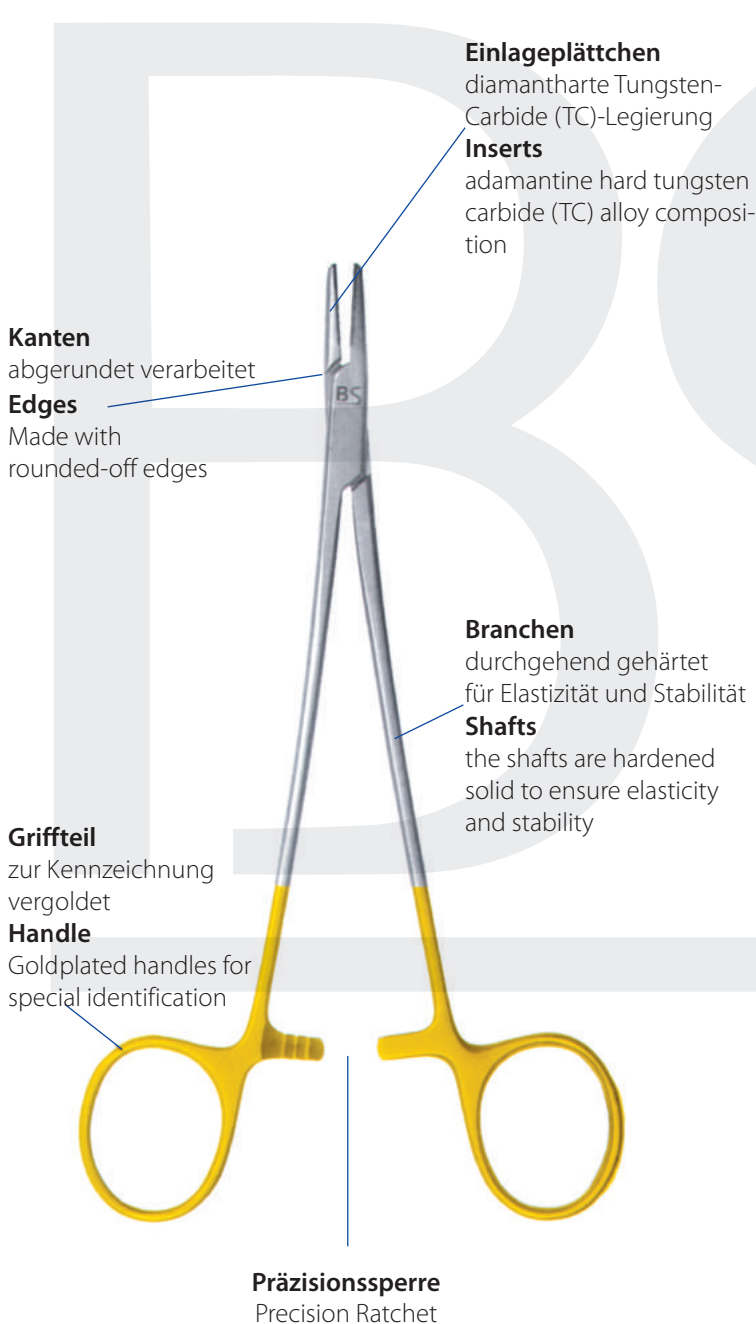

TC-Nadelhalter
TC Needle Holders

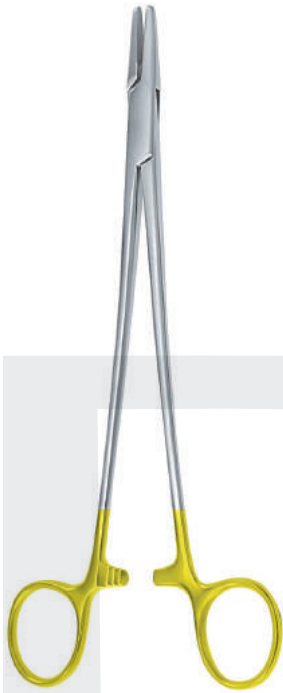

Hegar



20 cm
08-000-20

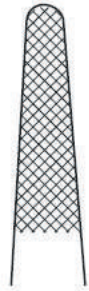

24 cm
08-000-24

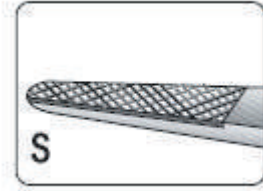

Mayo-Hegar



14 cm
08-002-14



16 cm
08-002-16



18 cm
08-002-18



20 cm
08-002-20



24 cm
08-002-14



26 cm
08-002-26





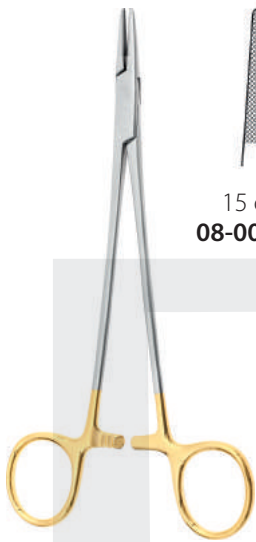

30 cm
08-002-30







De Bakley

- 
 15 cm
08-004-15
- 
 18 cm
08-004-18
- 
 20 cm
08-004-20
- 
 23 cm
08-004-23



- 
 26 cm
08-004-26
- 
 31 cm
08-004-31
- 
 37 cm
08-004-37



18 cm
08-010-18





20 cm
08-010-20





23 cm
08-010-23



**De Bakley
sehr fein
very delicate**

- 
 16,5 cm
08-006-16
- 
 21 cm
08-006-21



- 
 16,5 cm
08-008-16
- 
 21 cm
08-008-21

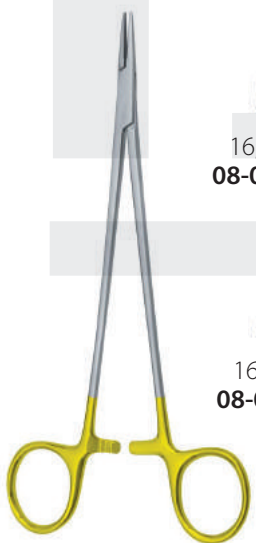

**De Bakley
grazil
fine**

TC-Nadelhalter
TC Needle Holders



Crile-Wood

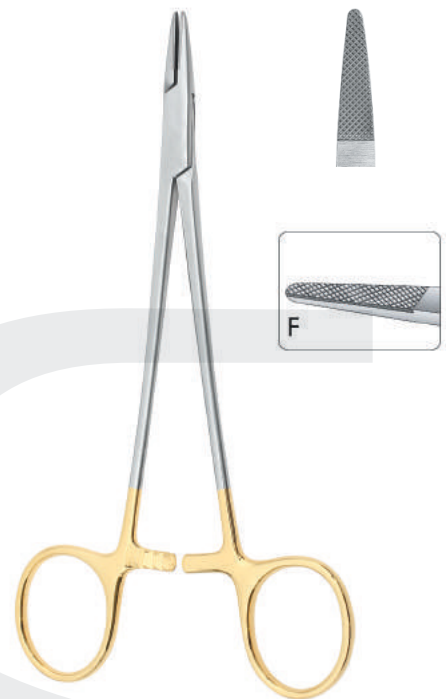

Baby-Crile-Wood
15 cm 08-014-15

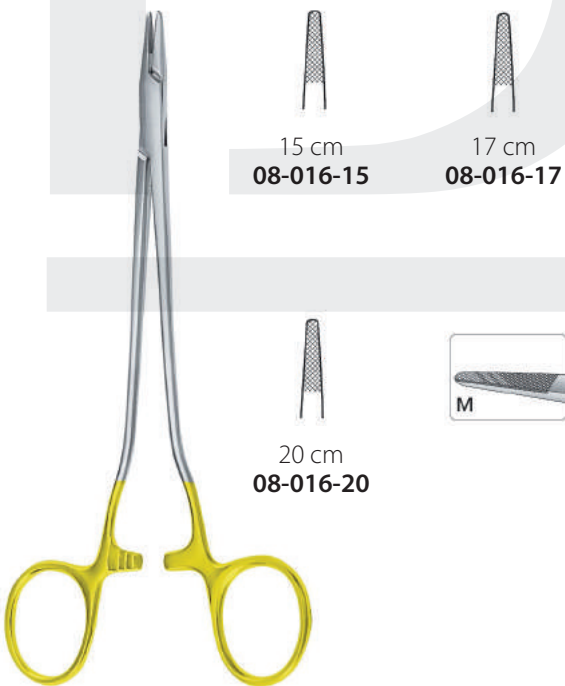

Senning

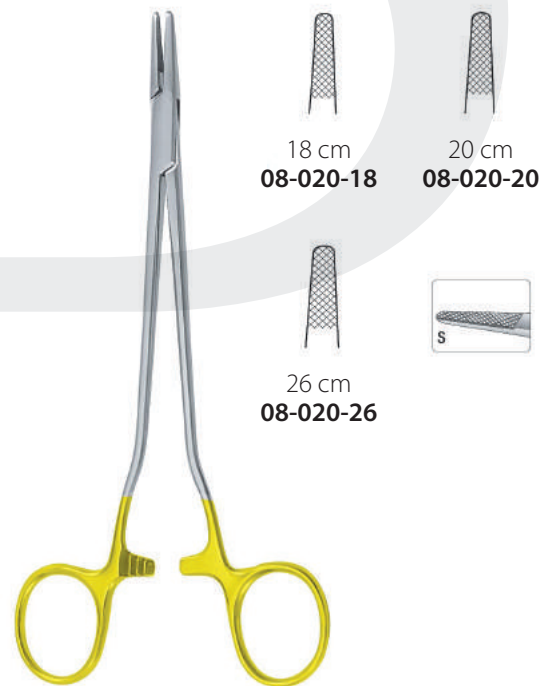

Sarot

08

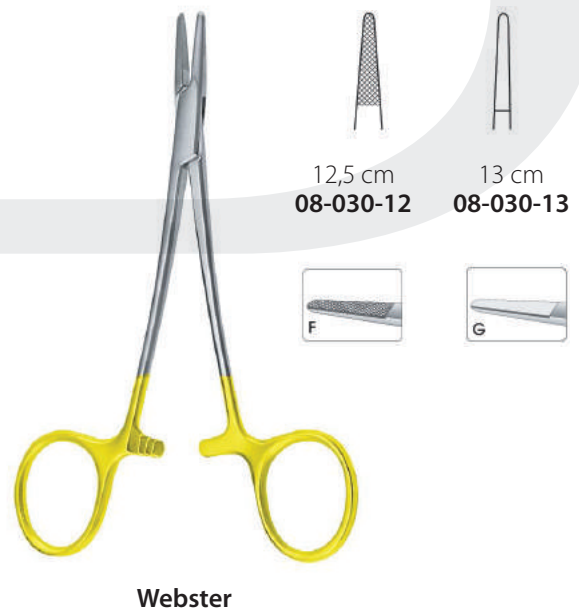
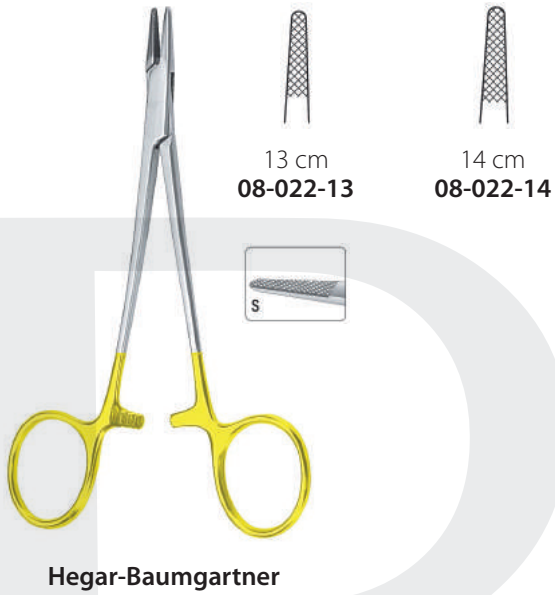



Kilner
13 cm 08-031-13



Derf
Derf-Converse

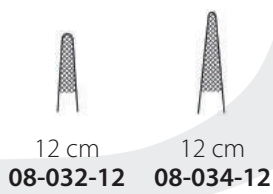

Nadelhalter mit Durchdrücktaste
with automatic release ratchet

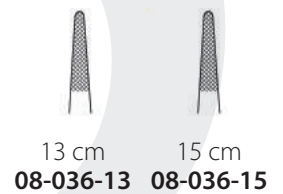

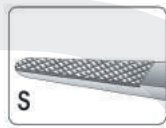
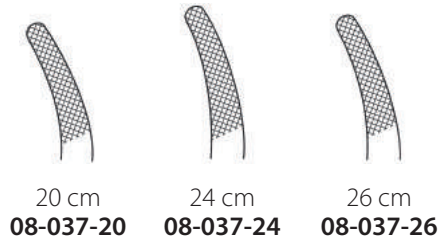

Heaney

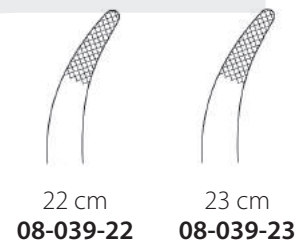

Stratte

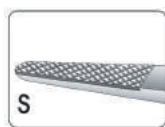
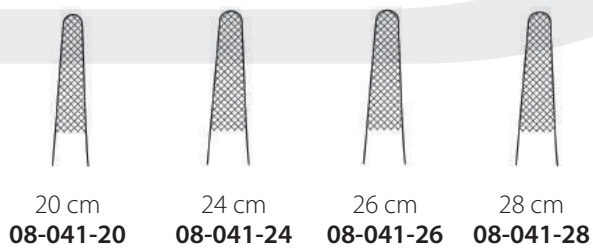
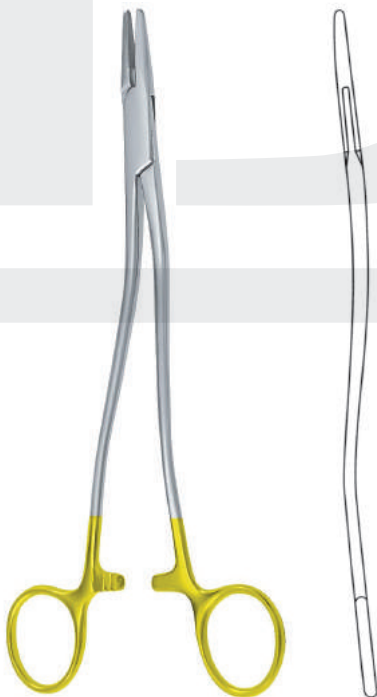

Bozemann

TC-Nadelhalter
TC Needle Holders

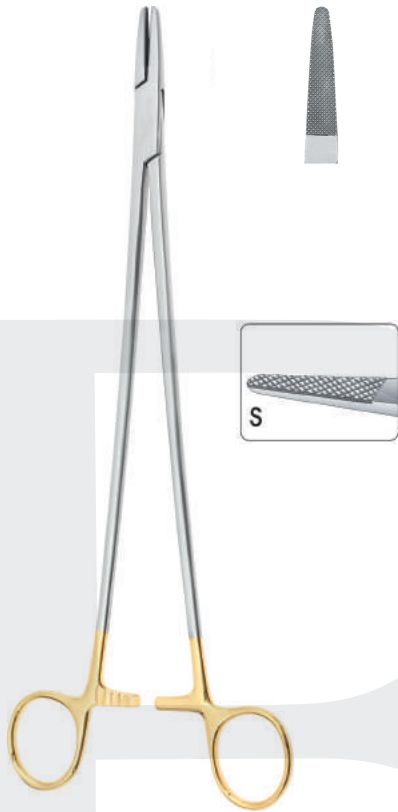

Masson
27 cm 08-042-27

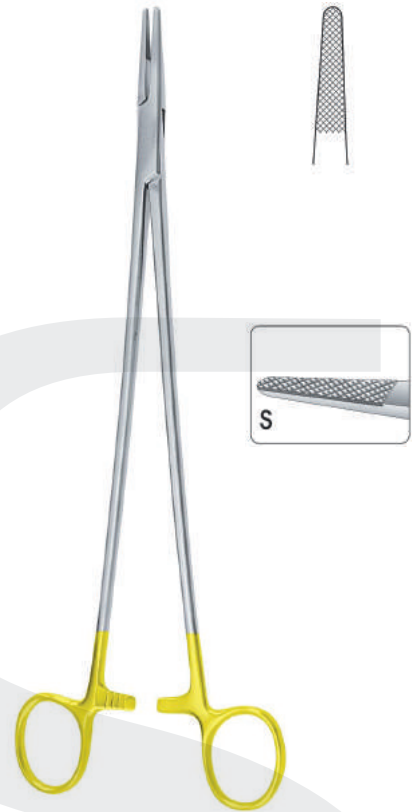

Wangensteen
27 cm 08-044-27

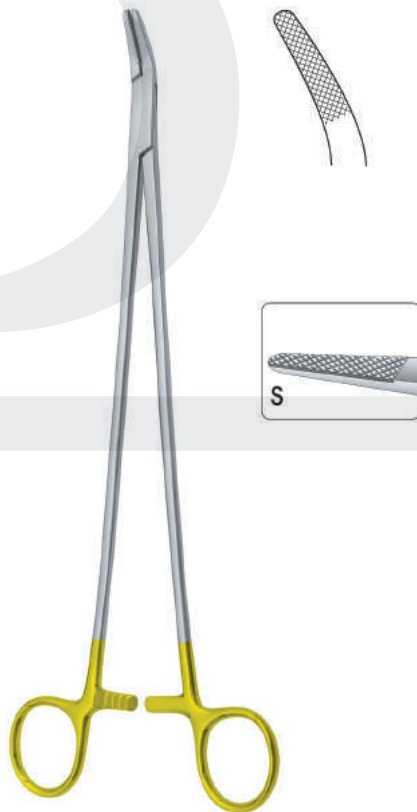

Finocchietto
27 cm 08-045-27



Olsen-Hegar



12,5 cm
08-046-12

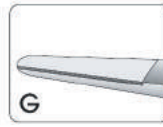

14 cm
08-048-14



16,5 cm
08-048-16



18 cm
08-048-18

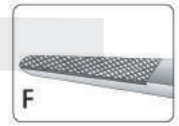

Gillies



11 cm
08-049-11

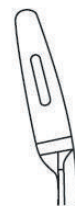

16 cm
08-049-16



15 cm
08-051-15



16 cm
08-051-16



TC-Nadelhalter
TC Needle Holders



Mathieu

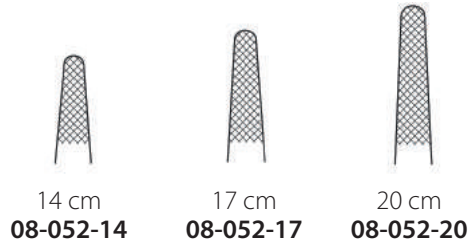

Mathieu
kräftiges Modell
heavy model

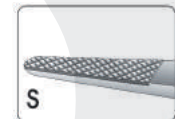

Mathieu
schlank
slim

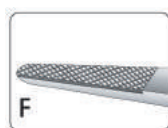
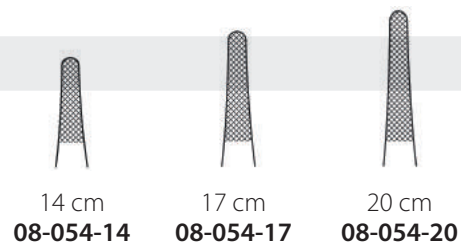

08

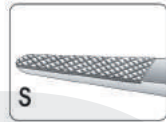

Lichtenberg
20 cm 08-056-20

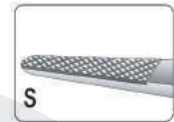

Hösel
26 cm 08-058-26



20 cm
08-057-20



26 cm
08-057-26



Nadelhalter mit langem Hals
Needle Holder with long neck

TC-Nadelhalter
TC Needle Holders

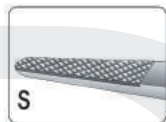
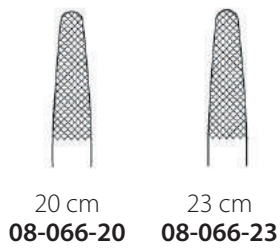

Zweifel

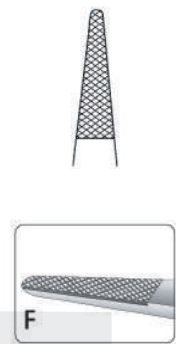

Toennis
18 cm **08-070-18**

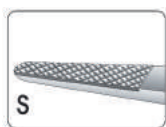
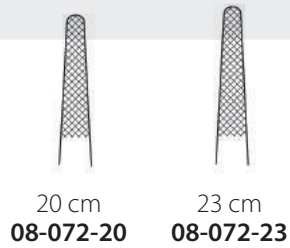

Langenbeck



Langenbeck

08

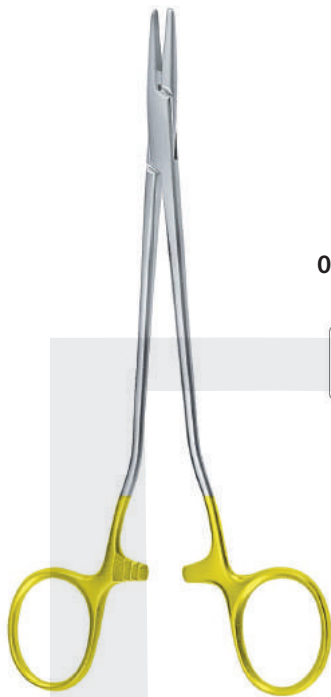

Hegar-Vascular

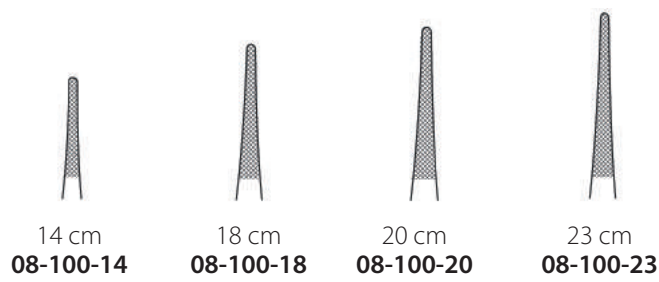

Hegar-Vascular
fein
fine

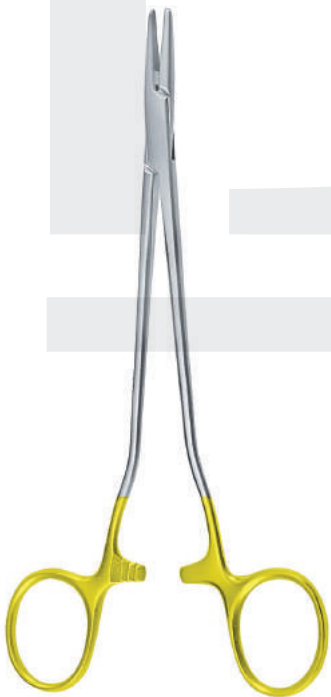
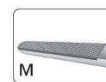
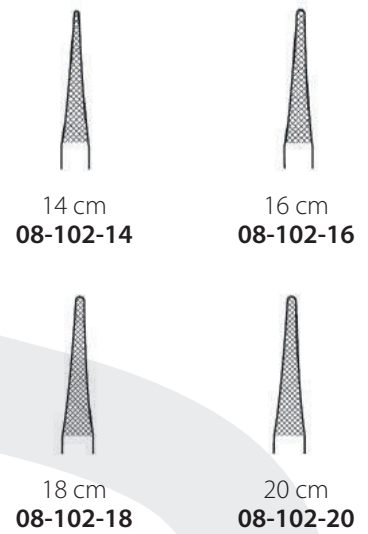



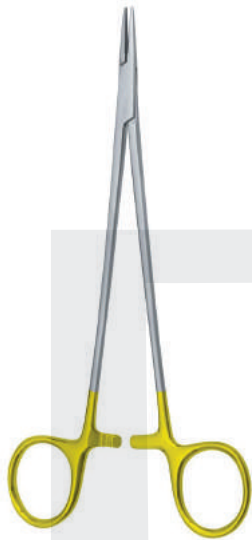

Hegar-Vascular
fein
fine











Micro-Vascular

- 
14 cm
08-106-14
- 
18 cm
08-106-18
- 
20 cm
08-106-20
- 
23 cm
08-106-23







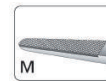

Ryder-Vascular

- 
13 cm
08-110-13
 - 
15 cm
08-110-15
 - 
18 cm
08-110-18
-
- 
20 cm
08-110-20
 - 
23 cm
08-110-23
 - 
26 cm
08-110-26



Ryder-Mikro

- 
13 cm
08-112-13
- 
15 cm
08-112-15
- 
18 cm
08-112-18
- 
20 cm
08-112-20
- 
23 cm
08-112-23
- 
26 cm
08-112-26

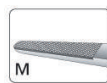



Dietrich-Vascular

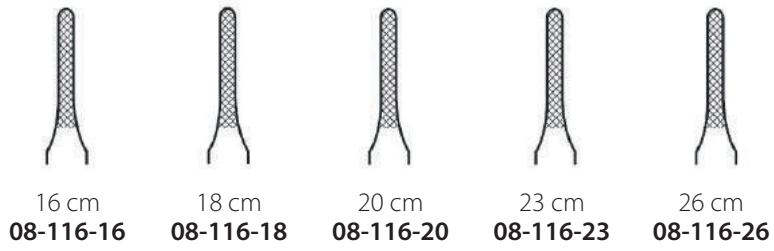

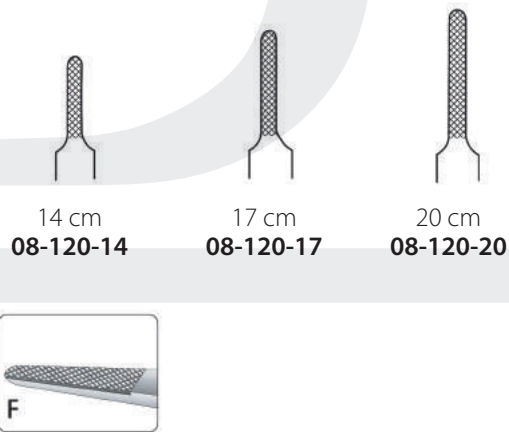

Mathieu-Ryder







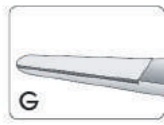

Langenbeck-Ryder
20 cm 08-130-20

TC-Nadelhalter
TC Needle Holders



-  14 cm
08-610-14
-  14 cm
08-611-14





-  14 cm
08-612-14
-  18 cm
08-612-18
-  22 cm
08-612-22
-  14 cm
08-613-14
-  18 cm
08-613-18
-  22 cm
08-613-22



Castroviejo



-  **mit Sperre**
with catch
-  14 cm **08-672-14** 14 cm **08-673-14**
- 18 cm **08-672-18** 18 cm **08-673-18**

- mit Sperre**
with catch
- 14 cm **08-674-14** 14 cm **08-675-14**
- 18 cm **08-674-18** 18 cm **08-675-18**

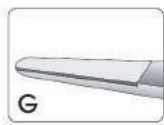

Barraquer



-  12 cm
08-680-12
-  **08-680-14**
-  **08-681-14**



Castroviejo

NEURO

11





biegsam/malleable
07+09/180 mm **11-112-07**
11+13/180 mm **11-112-11**
15+18/180 mm **11-112-15**
18+22/180 mm **11-112-18**

Cushing



biegsam/malleable
09/200 mm **11-113-09**
12/200 mm **11-113-12**
12/250 mm **11-113-13**



Heifetz

flexibel/flexible
08/155 mm **11-115-08**
11/155 mm **11-115-11**
14/155 mm **11-115-14**
17/155 mm **11-115-17**
08/200 mm **11-120-08**
11/200 mm **11-120-11**
14/200 mm **11-120-14**
17/200 mm **11-120-17**
20/200 mm **11-120-20**

konkav/concave
07/09 mm **11-124-07**
11/13 mm **11-124-11**
15/18 mm **11-124-15**
18/22 mm **11-124-18**



Olivecrona

konvex/convex
07/09 mm **11-125-07**
11/13 mm **11-125-11**
15/18 mm **11-125-15**
18/22 mm **11-125-18**

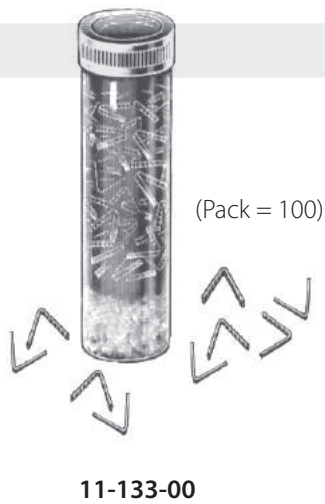
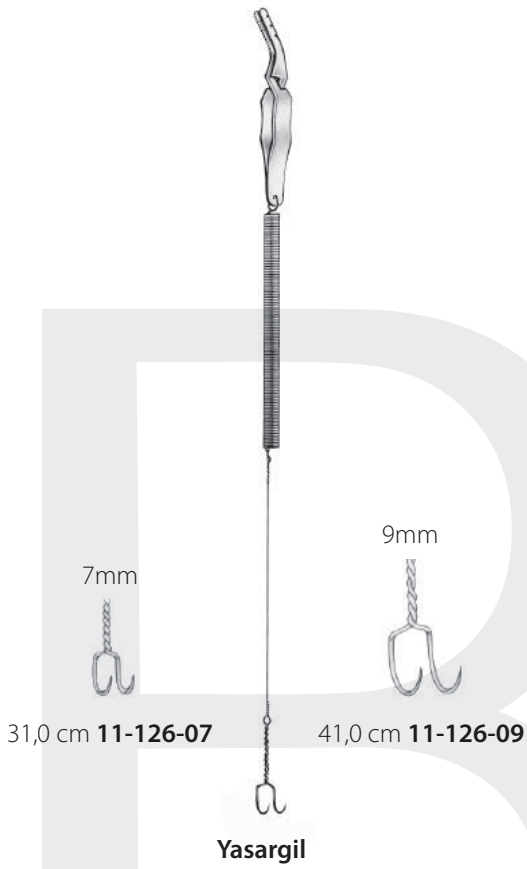

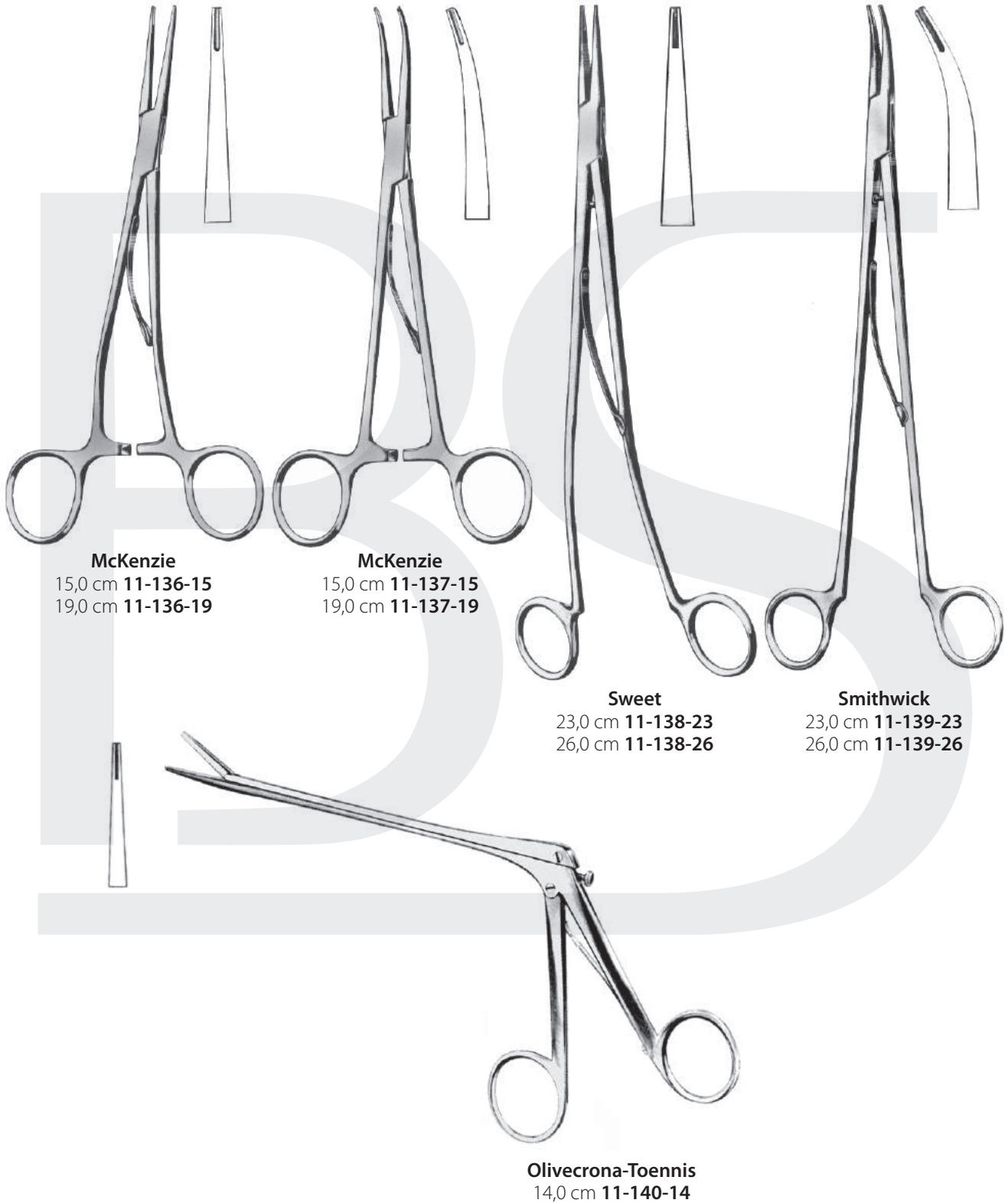

McKenzie
15,0 cm 11-136-15
19,0 cm 11-136-19

McKenzie
15,0 cm 11-137-15
19,0 cm 11-137-19

Sweet
23,0 cm 11-138-23
26,0 cm 11-138-26

Smithwick
23,0 cm 11-139-23
26,0 cm 11-139-26

Olivecrona-Toennis
14,0 cm 11-140-14

Schädelhalter
Skull Traction Tongs



Crutchfield
11-150-02



Crutchfield
11-150-01



11-152-35
Ø 3,5 mm



11-152-50
Ø 5,0 mm

Vorbohrer
Drill points



Crutchfield
11-150-03

Ersatzdorn (ohne Abb.)
Spare Pin only (without illustration)
11-151-00



Dahlgren
20,0 cm 11-154-20

De Vilbiss
20,0 cm 11-156-21

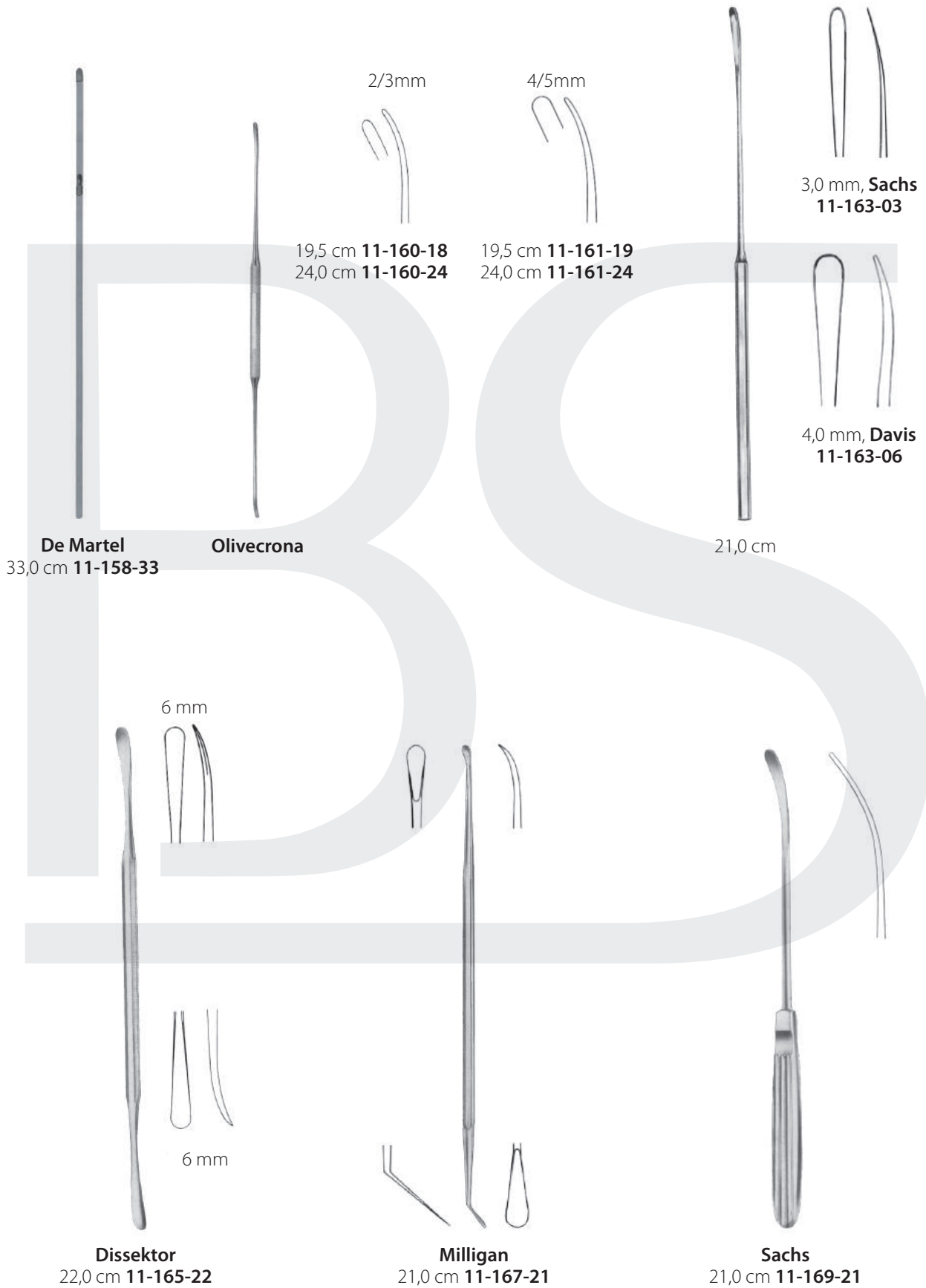



Frazier
15,0 cm 11-170-01



Hoehn
15,0 cm 11-170-02



Hoehn
15,0 cm 11-170-03

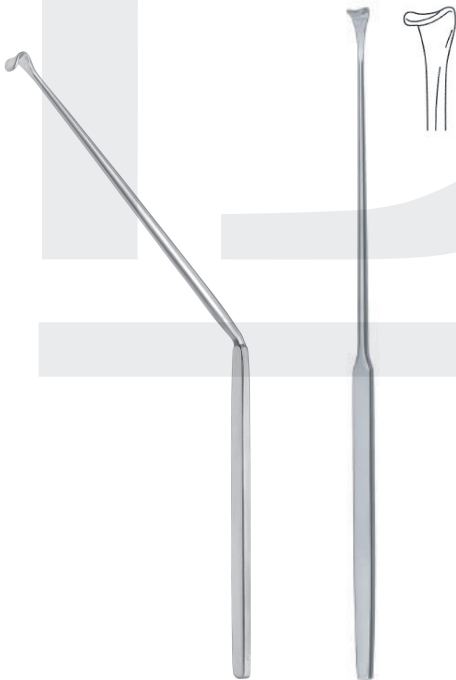

Love 11-172-02 18,0 cm
Love 11-172-01 19,0 cm
Love 11-172-03 14,0 cm



Haken Retractor
19,0 cm 11-173-19

Wurzelhaken, Messer
 Root Retractors, Knives

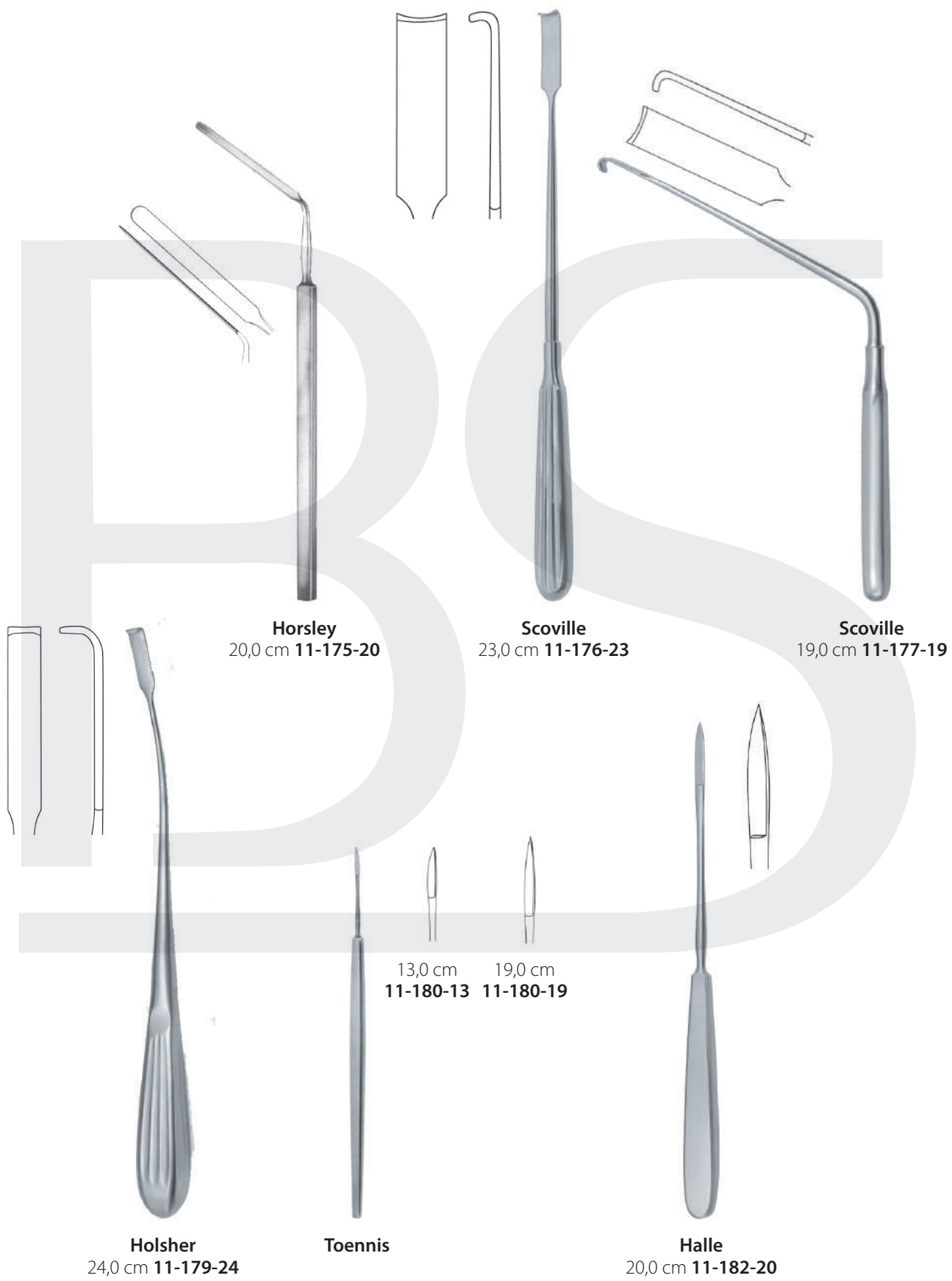

Horsley
 20,0 cm 11-175-20

Scoville
 23,0 cm 11-176-23

Scoville
 19,0 cm 11-177-19

Holsher
 24,0 cm 11-179-24

Toennis

13,0 cm 11-180-13 19,0 cm 11-180-19

Halle
 20,0 cm 11-182-20



Smithwick

17,0 cm **11-187-17**
21,0 cm **11-187-21**



Dandy

20,0 cm **11-188-20**



Adson

20,0 cm



11-190-20



11-196-20



Graham

16,5 cm **11-191-16**



Sachs

18,5 cm **11-192-18**



Toennis

15,0 cm **11-193-15**



Cushing

14,0 cm **11-194-14**



Frazier

13,0 cm **11-195-13**
18,0 cm **11-195-18**

Laminektomie Spreizer
Laminectomy Retractors



**Scoville
Wundspreizer, komplett**
Retractor, complete
11-302-00

bestehend aus/consisting of:
11-302-01 Rahmen/Frame
11-303-02 Haken/Hook
11-303-06 Haken/Hook

**Scoville - Haverfield
Rahmen allein**
Frame only
11-302-01

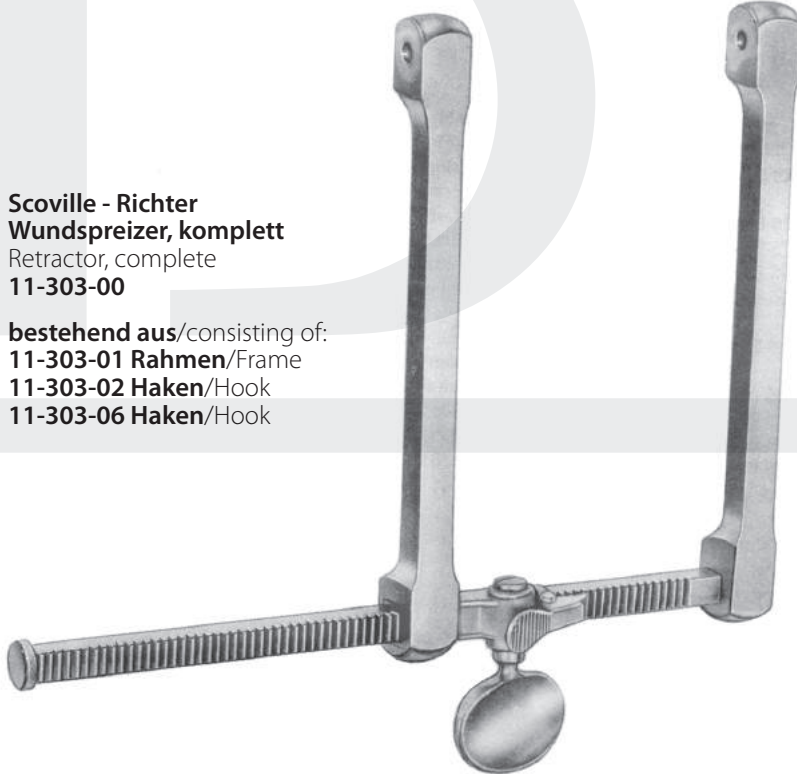

**Scoville - Richter
Wundspreizer, komplett**
Retractor, complete
11-303-00

bestehend aus/consisting of:
11-303-01 Rahmen/Frame
11-303-02 Haken/Hook
11-303-06 Haken/Hook

**Scoville
Rahmen allein**
Frame only
11-303-01



11-303-02 50 mm



11-303-03 70 mm



11-303-04 50 mm



11-303-05 70 mm



11-303-07 64x50 mm
11-303-08 88x25 mm



11-303-11 48x50 mm
11-303-12 64x50 mm
11-303-13 64x64 mm
11-303-14 80x57 mm



11-303-15 41x38 mm
11-303-16 67x44 mm



Caspar

11-354-00 Sperrer mit Gelenken und 10 Blätter
(11-358-01 - 11-358-15)
Retractor and joints and 10 blades

11-354-01 Sperrer, alleine
Retractor, only



Caspar

11-356-00 Gegensperrer mit Gelenken und 5 Blätter
(11-358-21 - 11-358-25)
Counter Retractor with joints and 5 blades

11-356-01 Gegensperrer, alleine
Counter Retractor, only

Caspar

11-355-00 Gegensperrer mit Gelenken und 5 Blätter
(11-358-21 - 11-358-25)
Counter Retractor with joints and 5 blades

11-355-01 Gegensperrer, alleine
Counter Retractor, only



11-358-01 40x23 mm
11-358-02 45x23 mm
11-358-03 50x23 mm
11-358-04 55x23 mm
11-358-05 60x23 mm



Pinzette zum Valvenwechsel
Blade ejector for blades with ball snap
11,5 cm **11-358-99**



11-358-21 45x23 mm
11-358-22 50x23 mm
11-358-23 55x23 mm
11-358-24 60x23 mm
11-358-25 65x23 mm



11-358-11 40x23 mm
11-358-12 45x23 mm
11-358-13 50x23 mm
11-358-14 55x23 mm
11-358-15 60x23 mm



11-358-31 50x25 mm
11-358-32 60x25 mm



Cloward

11-361-00 Sperrer komplett mit je 2 Valven
(11-363-02 - 11-363-06)
Wound Spreader, complete

11-361-01 Sperrer, allein
Wound Spreader, only



Cloward

11-362-00 Sperrer komplett mit je 2 Valven
(11-363-12 - 11-363-16)
Wound Retractor, complete

11-362-01 Sperrer, allein
Wound Retractor, only



- 11-363-02 40 mm
- 11-363-03 45 mm
- 11-363-04 50 mm
- 11-363-05 55 mm
- 11-363-06 60 mm

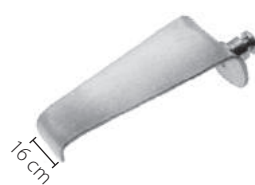

- 11-363-12 40 mm
- 11-363-13 45 mm
- 11-363-14 50 mm
- 11-363-15 55 mm
- 11-363-16 60 mm



Caspar

- 40 mm **11-366-40**
- 45 mm **11-366-45**
- 50 mm **11-366-50**
- 55 mm **11-366-55**
- 60 mm **11-366-60**
- 65 mm **11-366-65**
- 75 mm **11-366-75**
- 85 mm **11-366-85**



Caspar

- 11-367-00 Gegensperrer komplett mit 6 Valven (11-367-02 - 11-367-07)**
Counter Retractor, complete with 6 blades
- 11-367-01 Gegensperrer, allein**
Counter Retractor, only

- 11-367-35** 35 mm
- 11-367-40** 40 mm
- 11-367-45** 45 mm
- 11-367-50** 50 mm
- 11-367-55** 55 mm
- 11-367-60** 60 mm
- 11-367-65** 65 mm
- 11-367-70** 70 mm
- 11-367-75** 75 mm
- 11-367-80** 80 mm
- 11-367-85** 85 mm
- 11-367-99** 99 mm



Cloward
15,5 cm 11-371-15



Inge

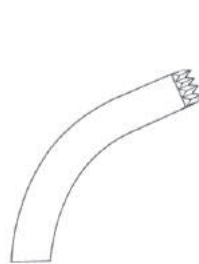

17,0 cm
11-375-02

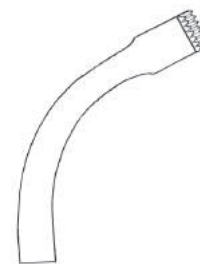

27,0 cm
11-376-27



11-375-01



Available in black coating

Cushing-Landolt
70x15 mm 11-400-01
90x15 mm 11-400-02
110x15 mm 11-400-03

HNO - Hals und Nase
ENT - Nose and Throat

17





Brünings
19,0 cm 17-006-19



Frenzel
16,5 cm 17-007-16



Hartmann
15,0 cm 17-011-15



Tobold
16,0 cm 17-013-16

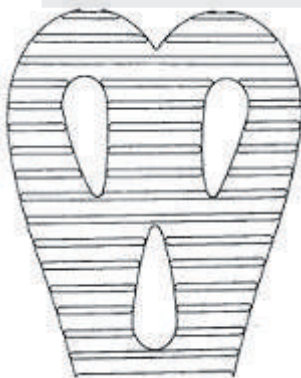

17-017-01



17-017-02



Wieder, 15,0 cm



Heister
13,0 cm 17-022-13



Molt
11,0 cm 17-023-10



Doyen-Jansen
13,0 cm 17-026-14



Denhardt
12,0 cm 17-028-12



Rosser-König
16,0 cm 17-029-16
19,0 cm 17-029-19



Whitehead
11,0 cm 17-031-11
13,0 cm 17-031-13
15,0 cm 17-031-15



Whitehead-Jennings
9,0 cm 17-033-09
11,0 cm 17-033-11
13,0 cm 17-033-13
15,0 cm 17-033-15

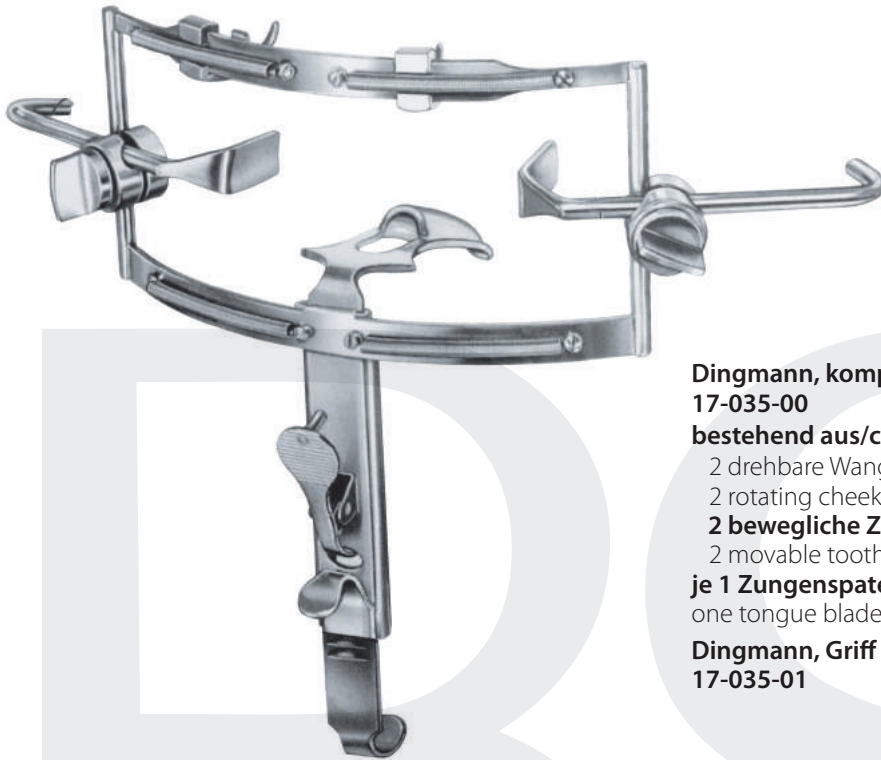

Dingmann, komplett/complete
17-035-00

bestehend aus/consisting of:

2 drehbare Wangenhalter
2 rotating cheek holders

2 bewegliche Zahnhaken und Fadenführer
2 movable tooth hooks and thread guide

je 1 Zungenspatel Dingmann 17-056-01, -02, -03
one tongue blade Dingmann each 17-056-01, -02, -03

Dingmann, Griff allein/Handle only
17-035-01



Davis-Boyle

17-041-00 Erwachsene/adult
17-042-00 Kleinkinder/infant
17-043-00 Kinder/children



Kilner-Doughty
17-044-19



Mclvor
17-045-00



Russel-Davis

28 x 65 mm **17-050-01**
33 x 75 mm **17-050-02**
37 x 80 mm **17-050-03**
40 x 90 mm **17-050-04**
45x100 mm **17-050-05**



Gast

28 x 65 mm **17-052-01**
34 x 74 mm **17-052-02**
38 x 87 mm **17-052-03**



McIvor

22 x 70 mm **17-054-01**
22 x 85 mm **17-054-02**
27 x 95 mm **17-054-03**

17



Davis-Boyle

21 x 30 mm **17-055-01**
23 x 65 mm **17-055-02*** *mit Ätherrohr
24 x 80 mm **17-055-03*** *with anesthetic tube
25 x 93 mm **17-055-04***
26x108 mm **17-055-05***



Dingmann

24x62 mm **17-056-01**
28x65 mm **17-056-02**
31x75 mm **17-056-03**



Negus
Bruststütze
Chest support
17-060-00



Sternberg
12,0 cm 17-070-12
14,0 cm 17-070-14
16,0 cm 17-070-16



Collin
16,0 cm 17-072-16
18,0 cm 17-072-18



17-073-99

Young
16,0 cm 17-073-16



Bishop
13,0 cm 17-074-13

Tonsillenfasszangen, Fasspinzetten

Tonsil Holding Forceps



White
18,0 cm **17-085-18**
23,5 cm **17-085-23**



Blohmke
20,5 cm **17-093-20**



Ballenger
21,5 cm **17-094-21**



Marschik
22,0 cm **17-096-22**

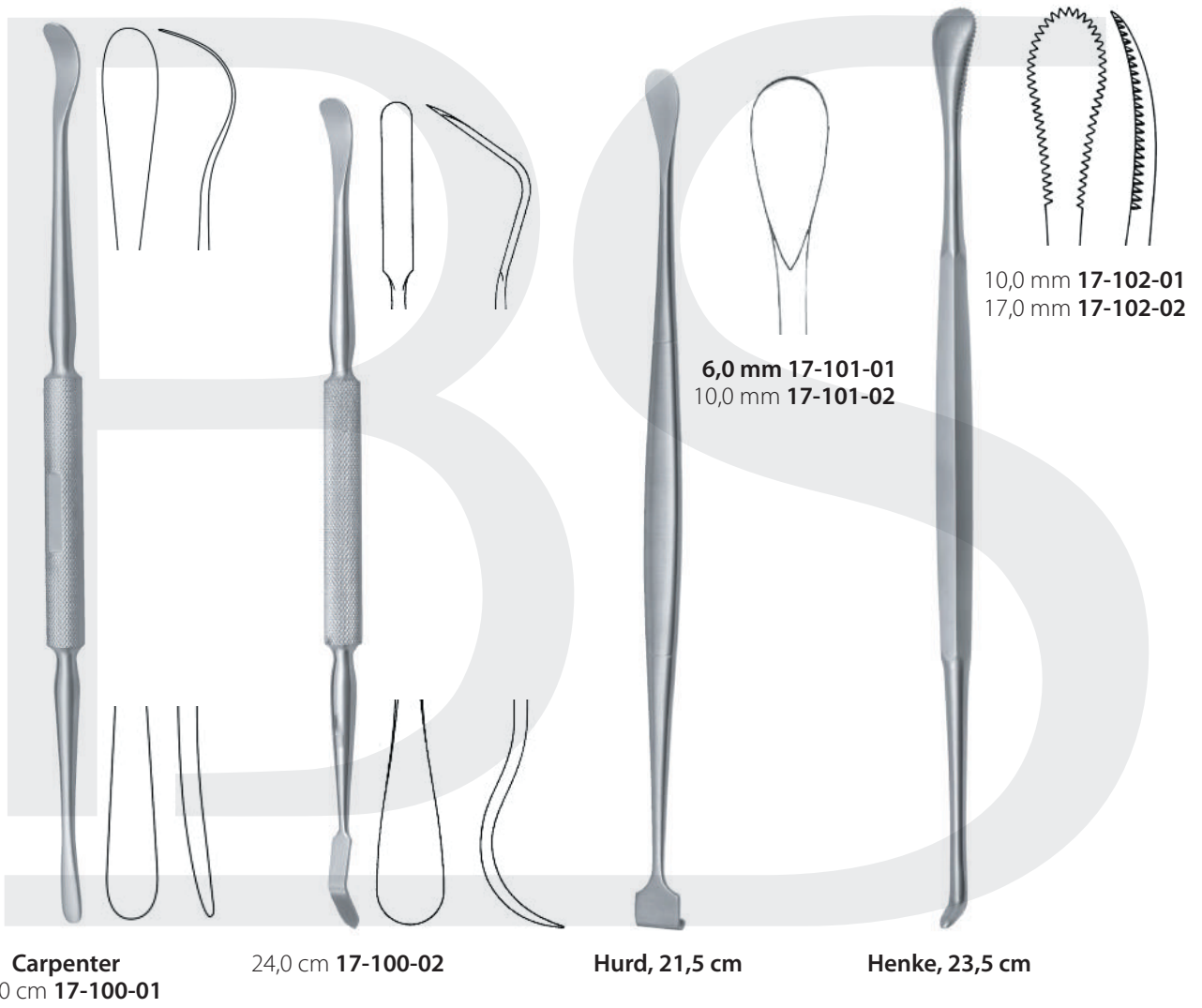

Tonsillennmesser, Tonsillenschnürer
Tonsil Knives, Tonsil Snares

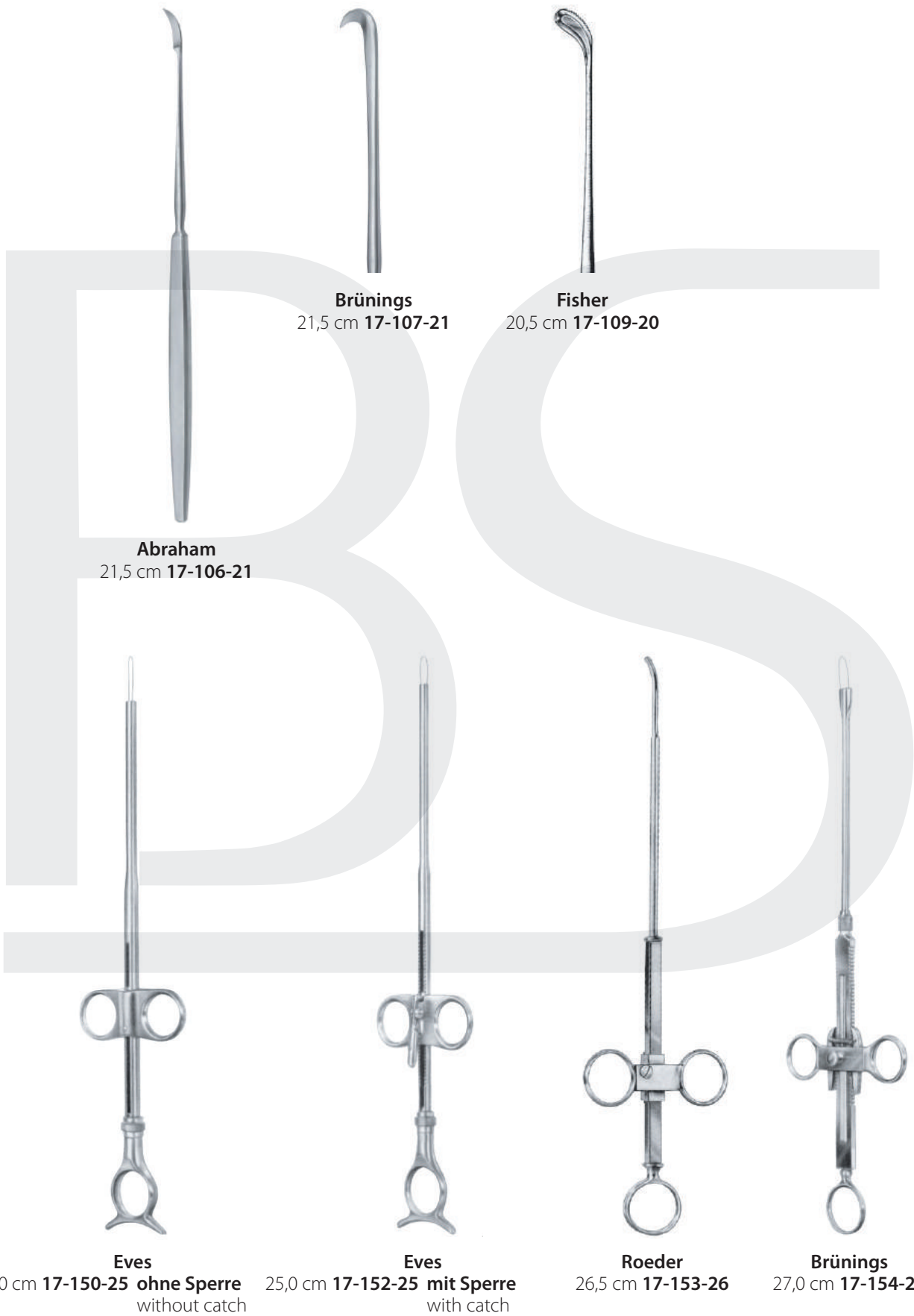

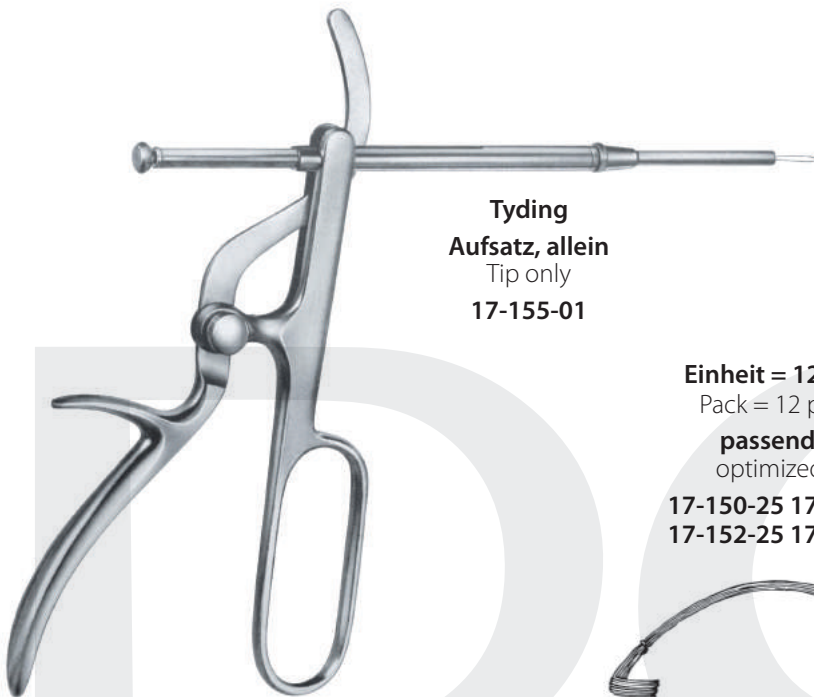

Tyding
Aufsatz, allein
Tip only
17-155-01

Einheit = 12 Stück
Pack = 12 pieces
passend für
optimized for
17-150-25 17-153-26
17-152-25 17-155-00



17-156-03 Ø 0,3 mm
17-156-05 Ø 0,5 mm

Einheit = 100 Stück
Pack = 100 pieces



17-157-04 40,0 mm
17-157-05 50,0 mm

passend für
optimized for
17-154-27

Tyding
mit Aufsatz
with tip
17-155-00

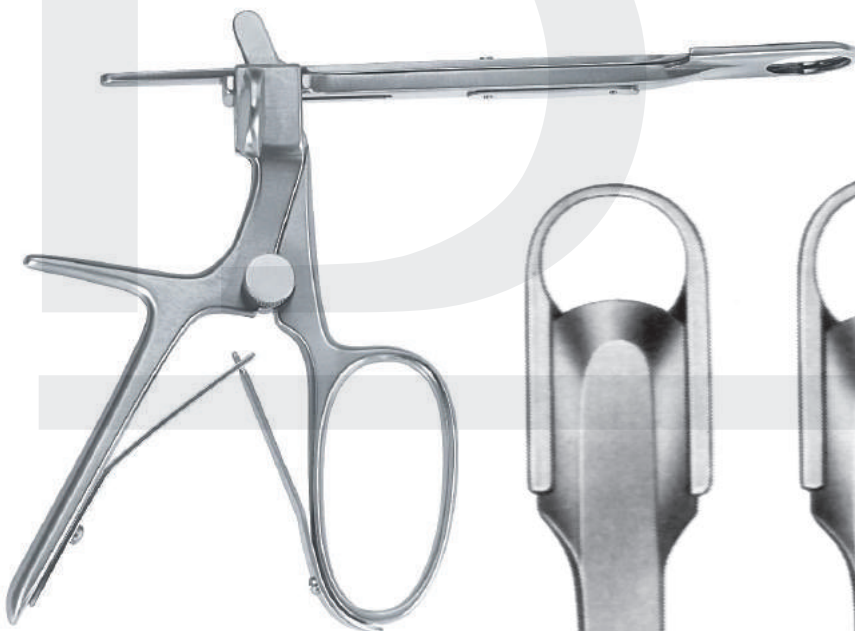

Sluder-Ballenger
komplett mit 3 Aufsätzen
complete with 3 tips
17-159-00
Griff allein
Handle only
17-159-04

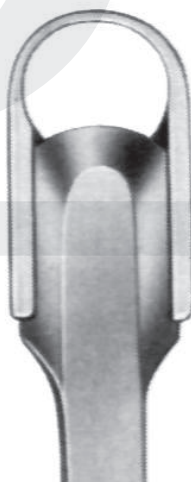

Fig. 1
17-159-01

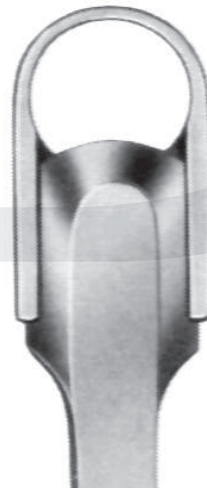

Fig. 2
17-159-02

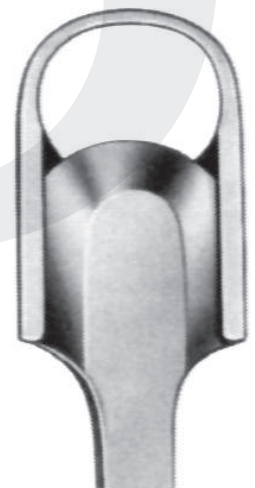
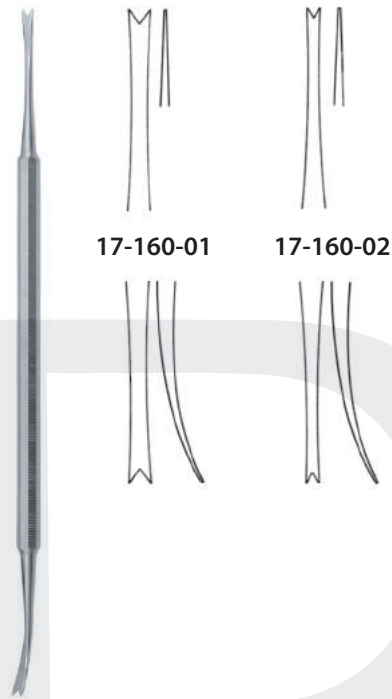

Fig. 3
17-159-03



17-160-01

17-160-02

Luniatschek, 18,0 cm



für linke Hand
for left Hand

für rechte Hand
for right hand

Hurd
21,0 cm 17-163-21

Hurd
21,0 cm 17-165-21

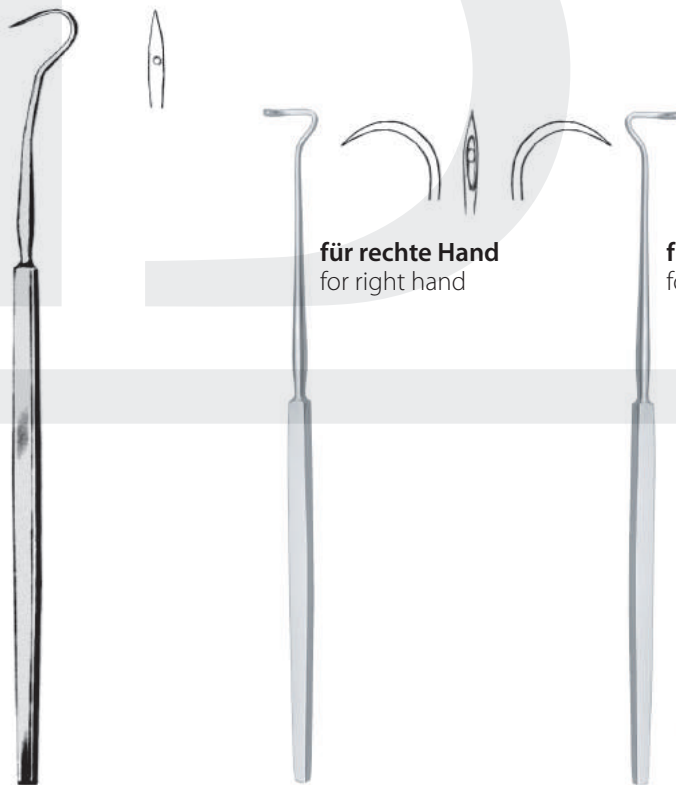

für rechte Hand
for right hand

für linke Hand
for left Hand

Von Eicken
25,0 cm 17-167-25

Dupuy Weiss, 22,0 cm
17-169-22

17-171-22

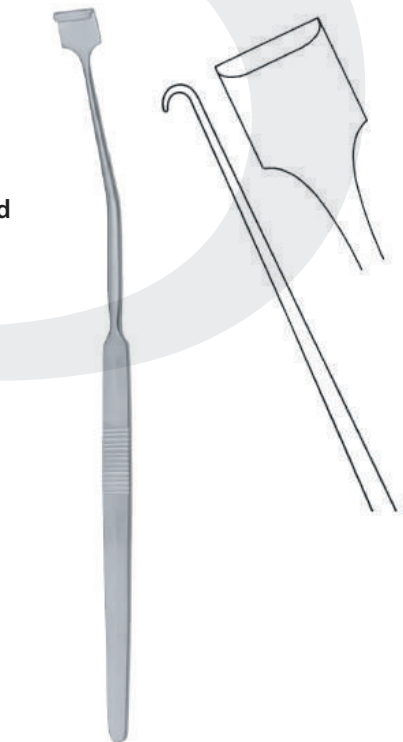

Nager
23,0 cm 17-175-23



Fig. 1
17-181-01
17-183-01



Fig. 2
17-181-02
17-183-02



Fig. 3
17-181-03
17-183-03



Fig. 4
17-181-04
17-183-04



Fig. 5
17-181-05
17-183-05



Fig. 6
17-181-06
17-183-06



Beckmann, 22,0 cm
17-181-01 - 17-181-06 17-183-01 - 17-183-06



La Force, 23,0 cm
Fig. 1 17-187-01
Fig. 2 17-187-02
Fig. 3 17-187-03

Ersatzklingen, Spare Blades



Fig. 1
17-187-11



Fig. 2
17-187-12



Fig. 3
17-187-13



- | | | |
|-----------|-------------------|-----------|
| 17-200-08 | Fig. 00 Ø 8,0 mm | 17-210-08 |
| 17-200-10 | Fig. 0 Ø 10,0 mm | 17-210-10 |
| 17-200-12 | Fig. 1 Ø 12,0 mm | 17-210-12 |
| 17-200-14 | Fig. 2 Ø 14,0 mm | 17-210-14 |
| 17-200-16 | Fig. 3 Ø 16,0 mm | 17-210-16 |
| 17-200-18 | Fig. 4 Ø 18,0 mm | 17-210-18 |
| 17-200-20 | Fig. 5 Ø 20,0 mm | 17-210-20 |
| 17-200-22 | Fig. 6 Ø 22,0 mm | 17-210-22 |
| 17-200-24 | Fig. 7 Ø 24,0 mm | 17-210-24 |
| 17-200-26 | Fig. 8 Ø 26,0 mm | 17-210-26 |
| 17-200-28 | Fig. 9 Ø 28,0 mm | 17-210-28 |
| 17-200-30 | Fig. 10 Ø 30,0 mm | 17-210-30 |

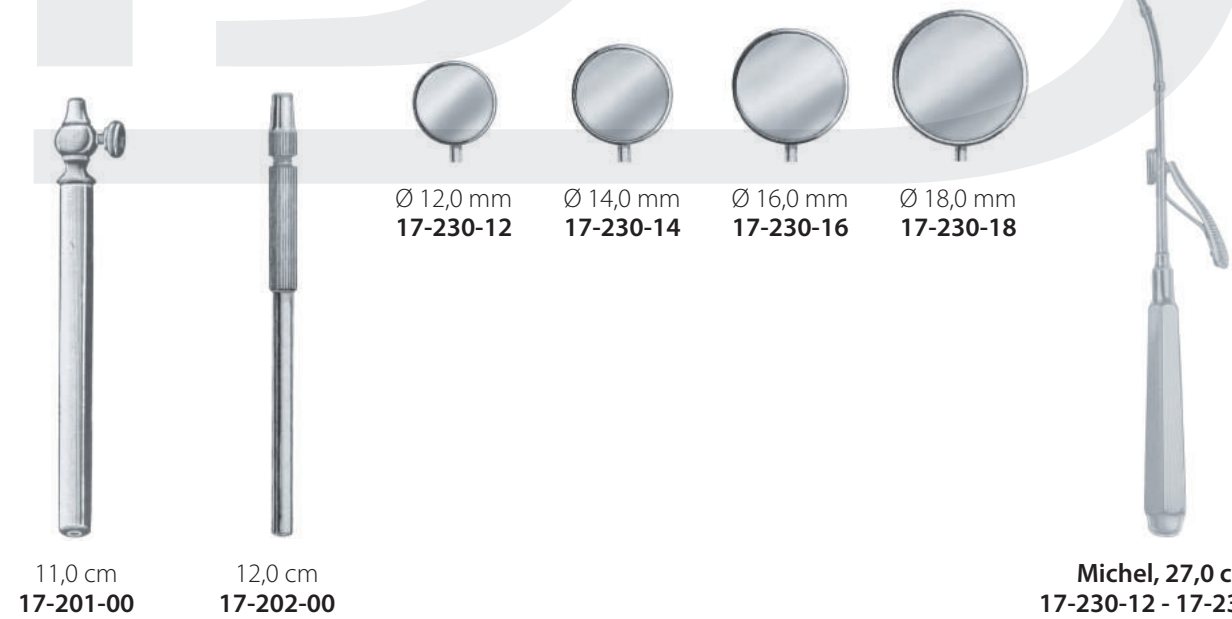



Reichert
23,0 cm **17-241-23**



Fränkel
22,0 cm **17-247-22**



Jurasz für Kinder / for children
19,0 cm **17-195-01**

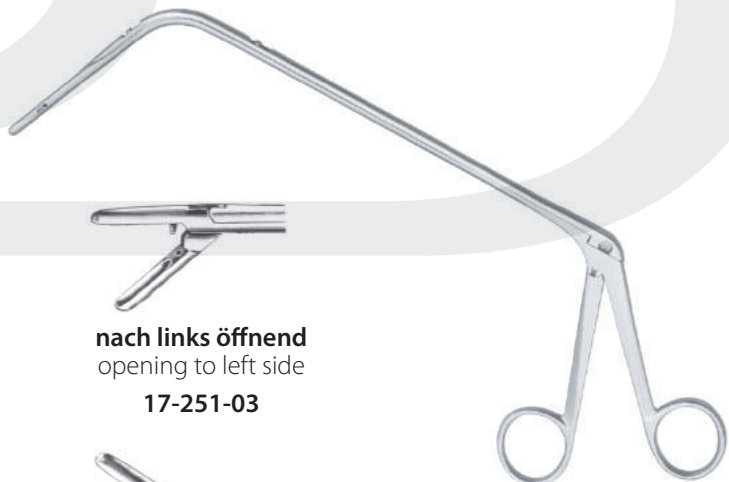

Jurasz, 22,0 cm



nach rechts öffnend
opening to right side
17-251-01



nach links öffnend
opening to left side
17-251-03



nach unten öffnend
opening down-ward
17-251-02



nach oben öffnend
opening up-ward
17-251-04



Huber Universal-Griff
17-262-00



**Brünings
Ansatzrohr starr, gerade**
Straight Tubes with Stylet, rigid
20,0 cm 17-262-20
30,0 cm 17-262-30
40,0 cm 17-262-40



**Brünings
Ansatzrohr starr, gebogen**
Curved Tubes with Stylet, rigid
20,0 cm 17-267-20

**Brünings
Ansatzrohr biegsam, gebogen**
Curved Tubes with Stylet, malleable
20,0 cm 17-268-20



Fränkel
17-270-01



Kahler
17-270-02



Fränkel
17-270-04



Scheinmann
17-270-06



Brünings
17-270-08
17-270-09



Lange
17-270-11



Krause
17-270-13
17-270-14



Scheinmann
17-270-15



Schumacher
17-270-16



Cordes
17-270-17
17-270-18



Rosenberg
17-270-19



Trousseau, 22,0 cm
12,0 cm **17-315-12**
14,0 cm **17-315-14**



Laborde
12,5 cm **17-317-12**
14,0 cm **17-317-13**



Iterson, 17,0 cm



17-321-01



17-321-02



Bose
16,0 cm **17-323-01**



Bose
16,0 cm **17-323-02**



Rose
13,5 cm **17-325-13**



Jackson
15,0 cm **17-329-15**

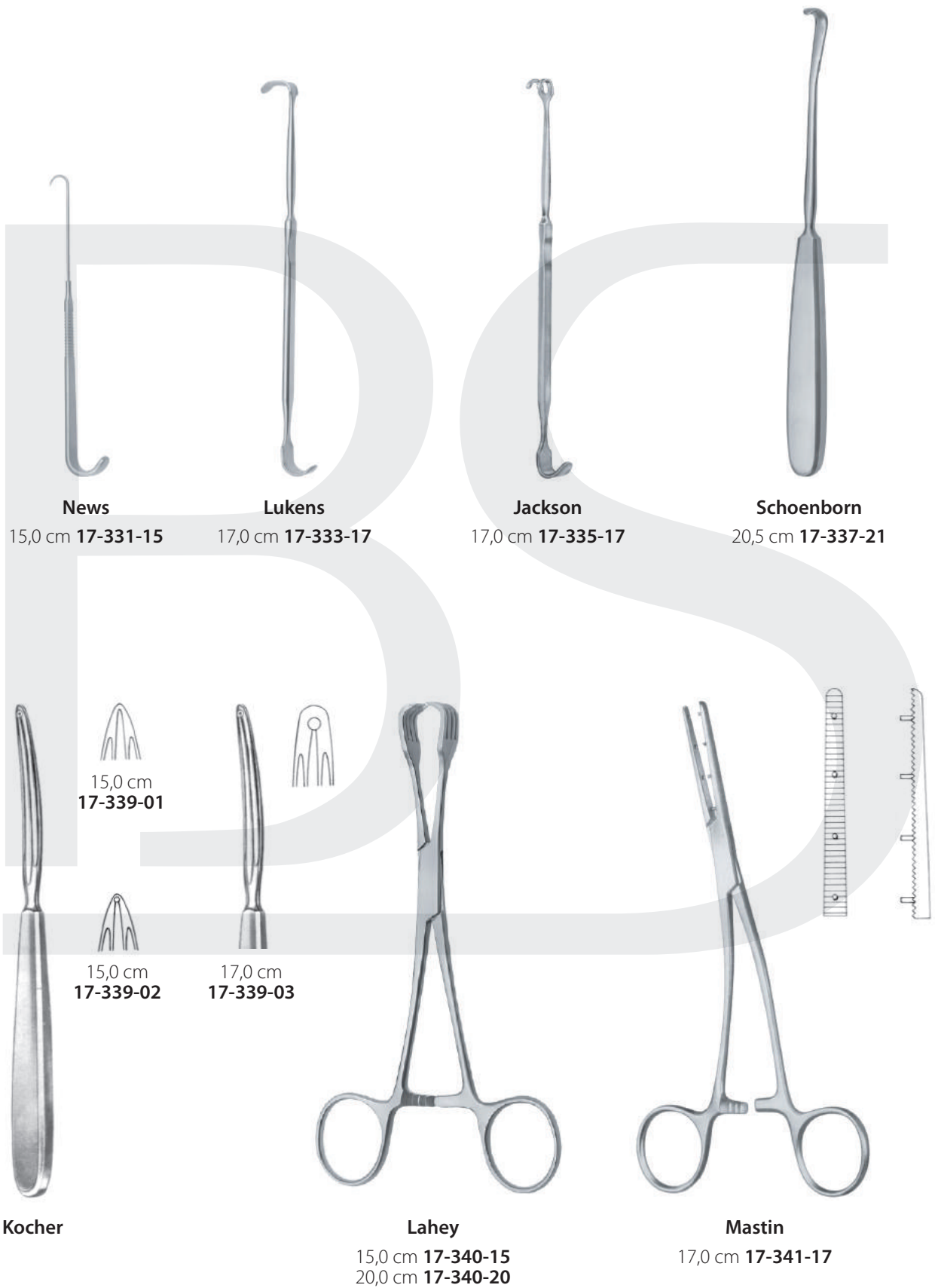

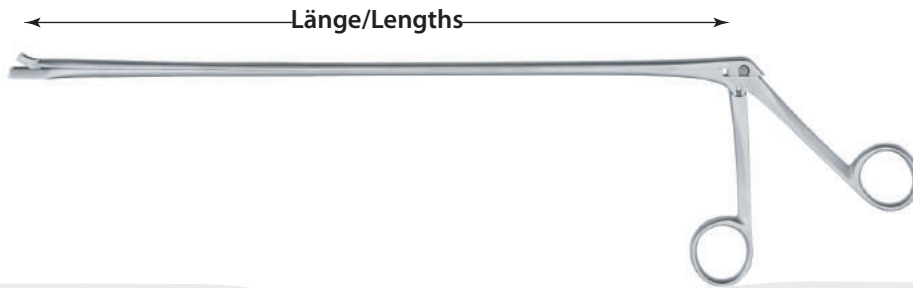

	Schaft 30 cm Shaft 30 cm	Schaft 40 cm Shaft 40 cm	Schaft 50 cm Shaft 50 cm	Schaft 60 cm Shaft 60 cm	
	17-410-30	17-410-40	17-410-50	17-410-60	Probeextensions-Zange Biopsy Punch
	17-411-30	17-411-40	17-411-50	17-411-60	Probeextensions-Zange Biopsy Punch
	17-412-30	17-412-40	17-412-50	17-412-60	Alligatorzange Alligator Forceps
ø 4 mm	17-413-30	17-413-40	17-413-50	17-413-60	Löffelzange Cup-shaped Forceps
	17-414-30	17-414-40	17-414-50	17-414-60	Probeextensions-Zange Biopsy Punch
	17-415-30	17-415-40	17-415-50	17-415-60	Fasszange Grasping Forceps
ø 4 mm	17-416-30	17-416-40	17-416-50	17-416-60	Löffelzange Cup-shaped Forceps



17-504-01

17-504-02

17-504-03

Voltolini



Tieck-Halle
13,0 cm



Hartmann-Halle
15,0 cm

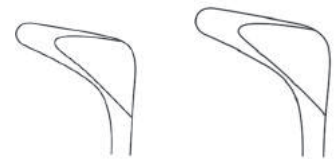

Fig. 1

Fig. 2

Steckschluss
aseptic joint

17-506-01

17-506-02

Schraubschluss
screw joint

17-507-01

17-507-02

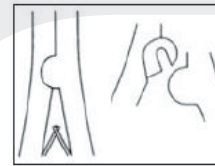

Steckschluss
aseptic joint

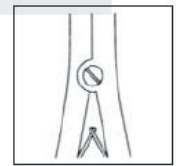

Schraubschluss
screw joint

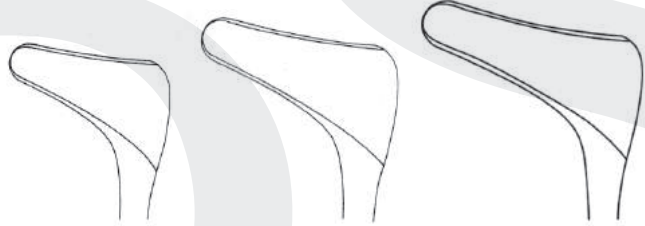

Fig. 1

Fig. 2

Fig. 3

Steckschluß
aseptic joint

17-508-01

17-508-02

17-508-03

Schraubschluß
screw joint

17-509-01

17-509-02

17-509-03



14,5 cm Modell Wien
leichtes Modell
lightweight



Fig. 1

Fig. 2

Fig. 3

17-515-01

17-515-02

17-515-03

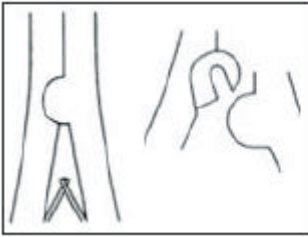

Steckschluss
aseptic joint

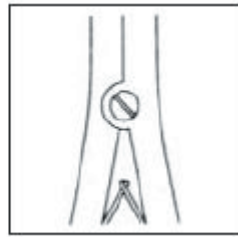

Schraubschluss
screw joint



Beckmann
13,0 cm 17-519-14



Beckmann
14,0 cm 17-519-15

Steckschluss/screw joint
Schraubschluss/aseptic joint

35mm
Fig. 1
17-524-01
17-525-01

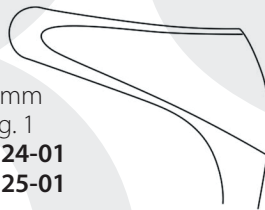

Steckschluss/screw joint
Schraubschluss/aseptic joint

50mm
Fig. 2
17-524-02
17-525-02

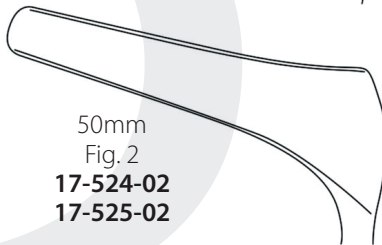

Steckschluss/screw joint
Schraubschluss/aseptic joint

75mm
Fig. 3
17-524-03
17-525-03

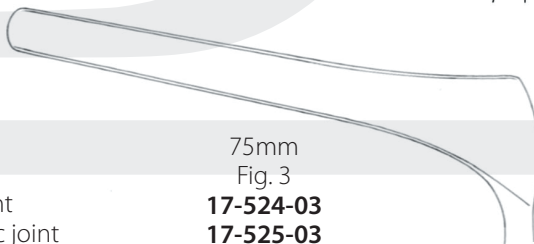

Steckschluss/screw joint
Schraubschluss/aseptic joint

90mm
Fig. 4
17-524-04
17-525-04

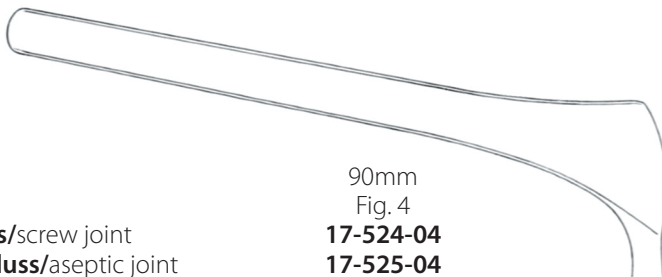

Killian
13,0 cm



Cottle



20 mm
Fig. 1
17-528-01
17-530-01 schwarz/black

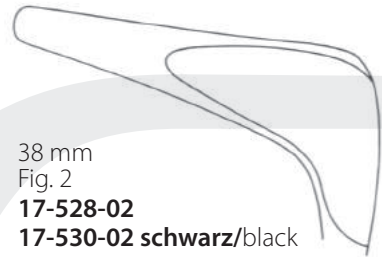

38 mm
Fig. 2
17-528-02
17-530-02 schwarz/black

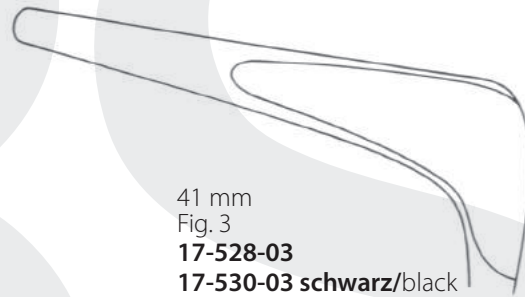

41 mm
Fig. 3
17-528-03
17-530-03 schwarz/black

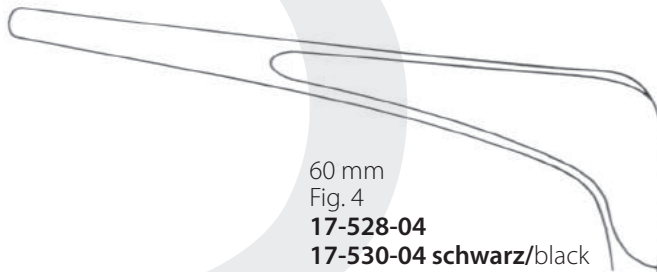

60 mm
Fig. 4
17-528-04
17-530-04 schwarz/black

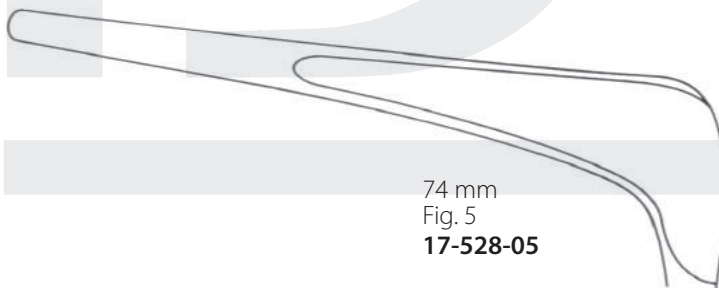

74 mm
Fig. 5
17-528-05



Cottle
schwarz
black finish



Tilley
13cm **17-601-13**
16cm **17-601-16**



Lubet-Barbon
20,0 cm **17-603-20**



Hartmann
16,0 cm **17-607-16**



Hartmann
20,0 cm **17-607-20**



Heymann
18,0 cm **17-609-18**



Littauer
18,0 cm **17-611-18**



Krause
26,0 cm 17-621-26



17-627-99
0,3 mm Ø



Krause-Voss
26,0 cm 17-623-26



Joseph, 14,5 cm



17-640-14

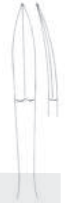

17-641-14



Brünings
16,0 cm 17-642-16



Fomon
16,0 cm 17-645-16



Freer
15,5 cm 17-646-15

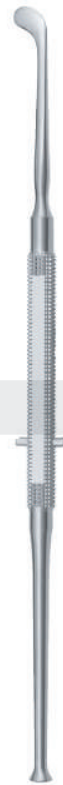

Freer
18,5 cm 17-646-18



19,0 cm 17-648-01



19,0 cm 17-648-02



19,0 cm 17-648-03

Sichelmesser
Sickle Knife



Converse
16,0 cm 17-649-16



Joseph
15,0 cm 17-650-15



Cottle
15,0 cm 17-652-15



Halle
18,0 cm 17-655-18

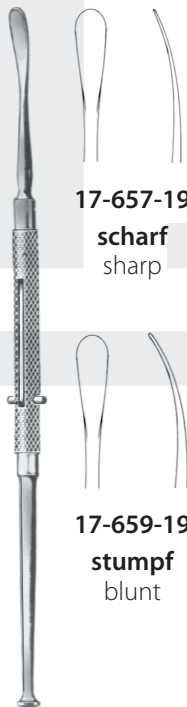

17-657-19
scharf
sharp

Freer, 19,0 cm



17-668-19

Freer, 19,0 cm



17-669-01

Freer, 19,0 cm



17-669-02



scharf/sharp

Freer
18,0 cm 17-663-18
20,0 cm 17-663-20



stumpf /blunt

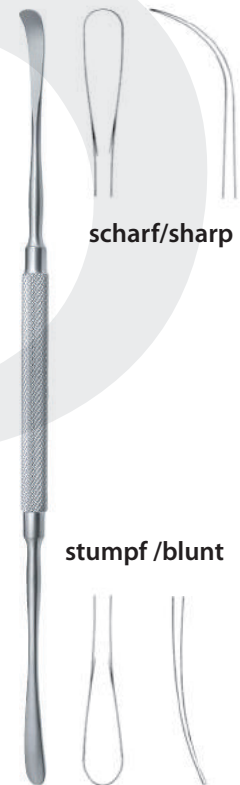

scharf/sharp

stumpf /blunt

Freer
20,0 cm 17-665-20

Septum- und Periost-Elevatoren
 Septum- and Periosteal Elevators



scharf/sharp

stumpf/blunt

Pierce
 21,0 cm 17-672-21



scharf/sharp

stumpf/blunt

Pennington
 21,0 cm 17-673-21



scharf/sharp

stumpf/blunt

Roger
 19,0 cm 17-675-19



Massing
 21,0 cm 17-679-21



Cottle
 21,0 cm 17-681-21



Cottle
 22,0 cm 17-681-22

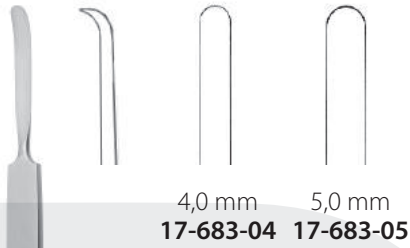

McKenty, 15,0 cm

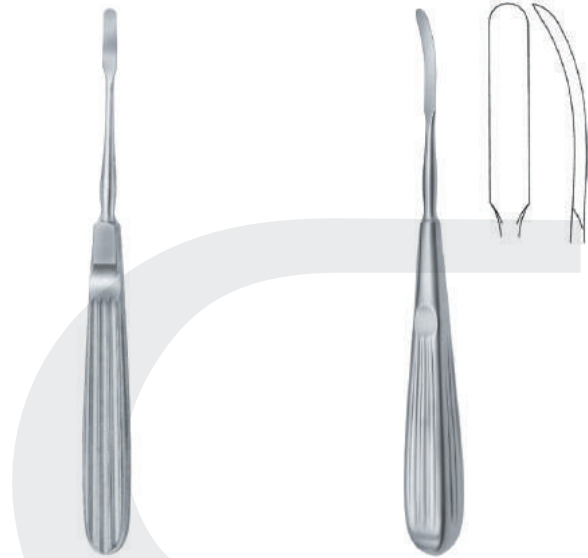

Joseph
16,0 cm 17-685-16

Joseph
16,0 cm 17-687-16



Joseph
22,0 cm 17-688-22

Sewall
20,0 cm 17-689-20



McKenty, 21,0 cm
17-691-21

Cottle, 22,0 cm
17-693-22

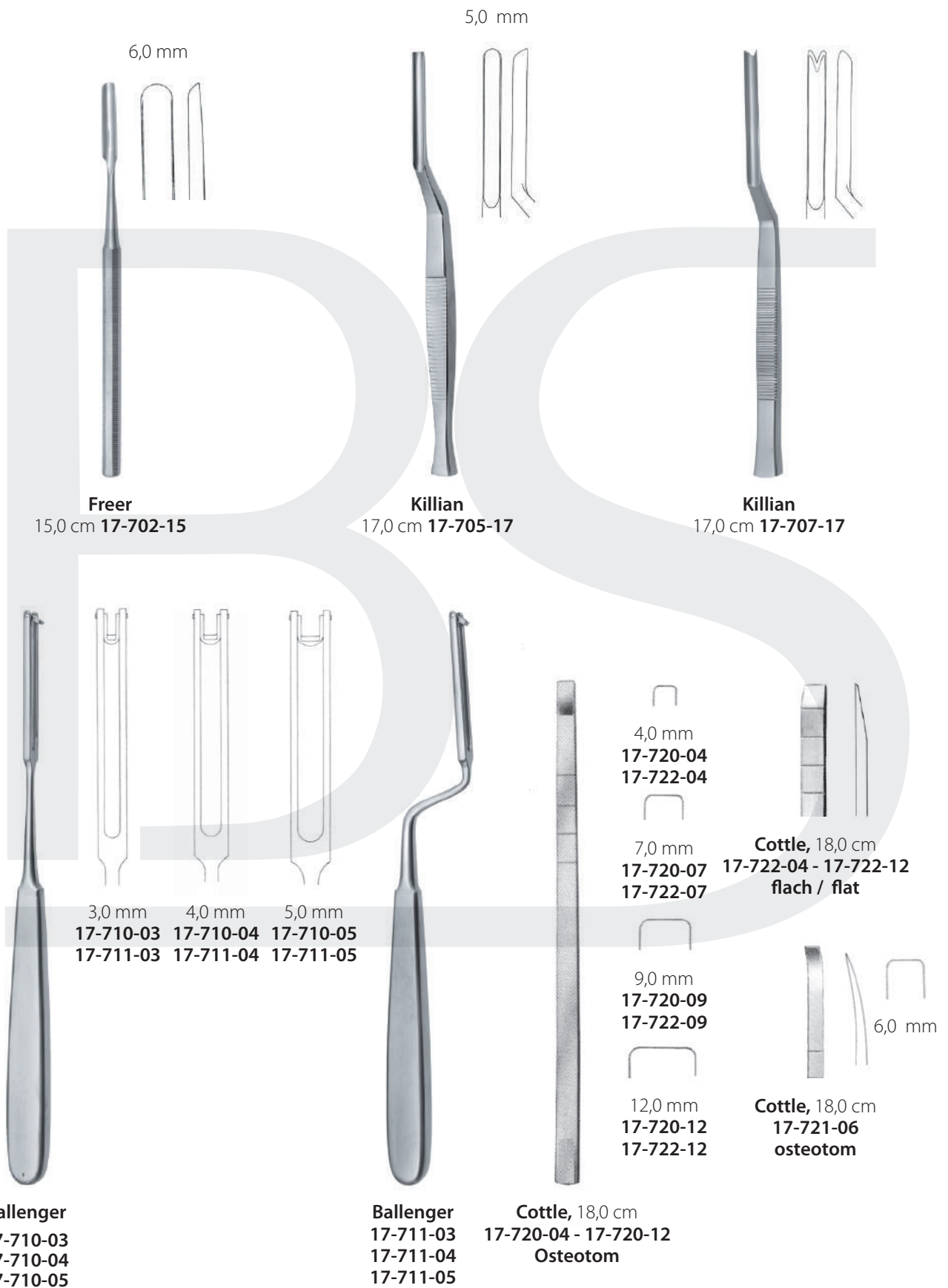

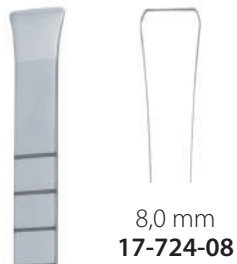

Cottle, 18,0 cm
17-724-08 - 17-724-16
Osteotom

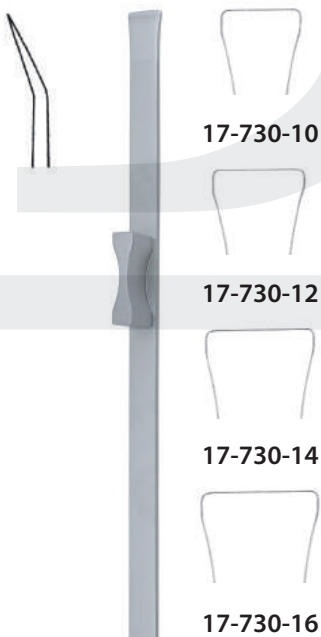
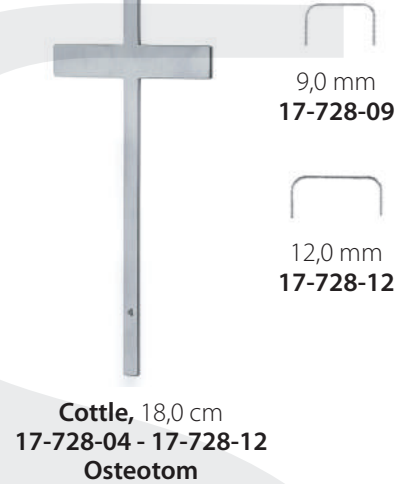
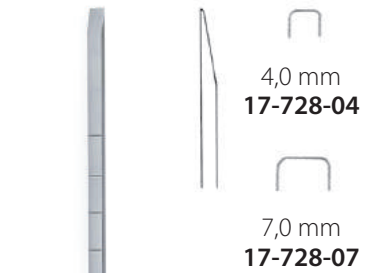

Hohlmeißel/Gouge



Osteotom

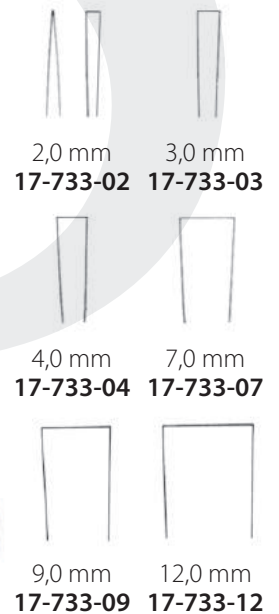

Walter, 19,0 cm

Walter, 19,0 cm

Nasenmeißel, -Osteotome und -Sägen
 Nasal Chisels, Osteotomes and Saws

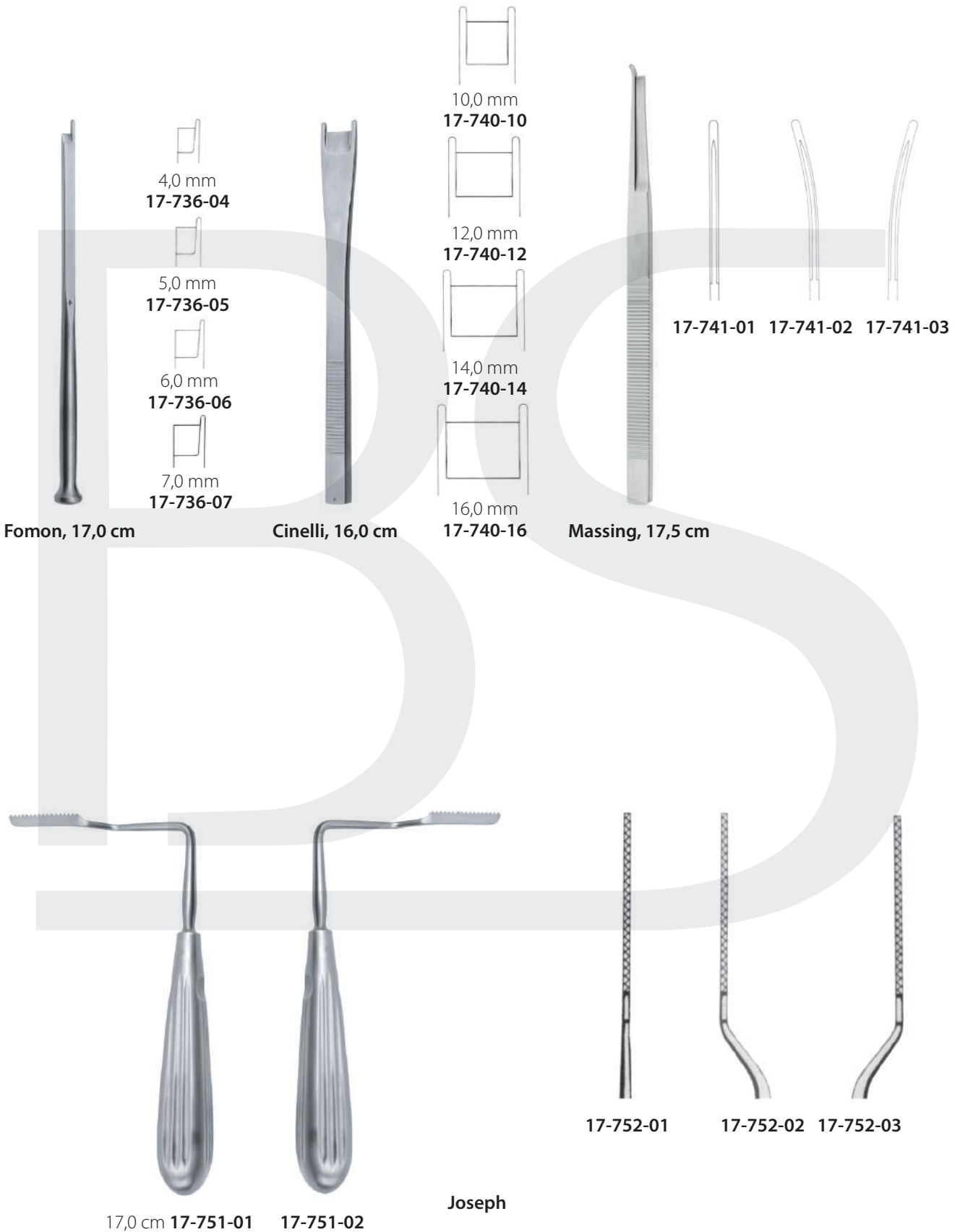



Cottle
Knorpelquetschinstrument
Bone crusher
17-756-00



Cottle
Columella
10,0 cm **17-760-10**



Cottle
14,0 cm **17-761-14**



Ogura
11,0 cm **17-762-11**

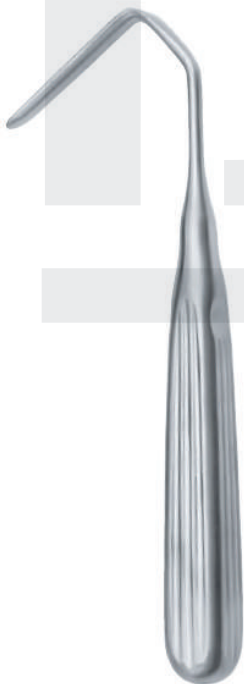

Aufricht
16,0 cm **17-767-16**



Walter
13,5 cm **17-769-13**



Kilner, 10,0 cm

17-770-10
scharf
sharp

17-770-11
stumpf
blunt



Converse
12,0 cm **17-771-12**



Cottle, 15,0 cm

17-772-01

17-772-02

17-772-03

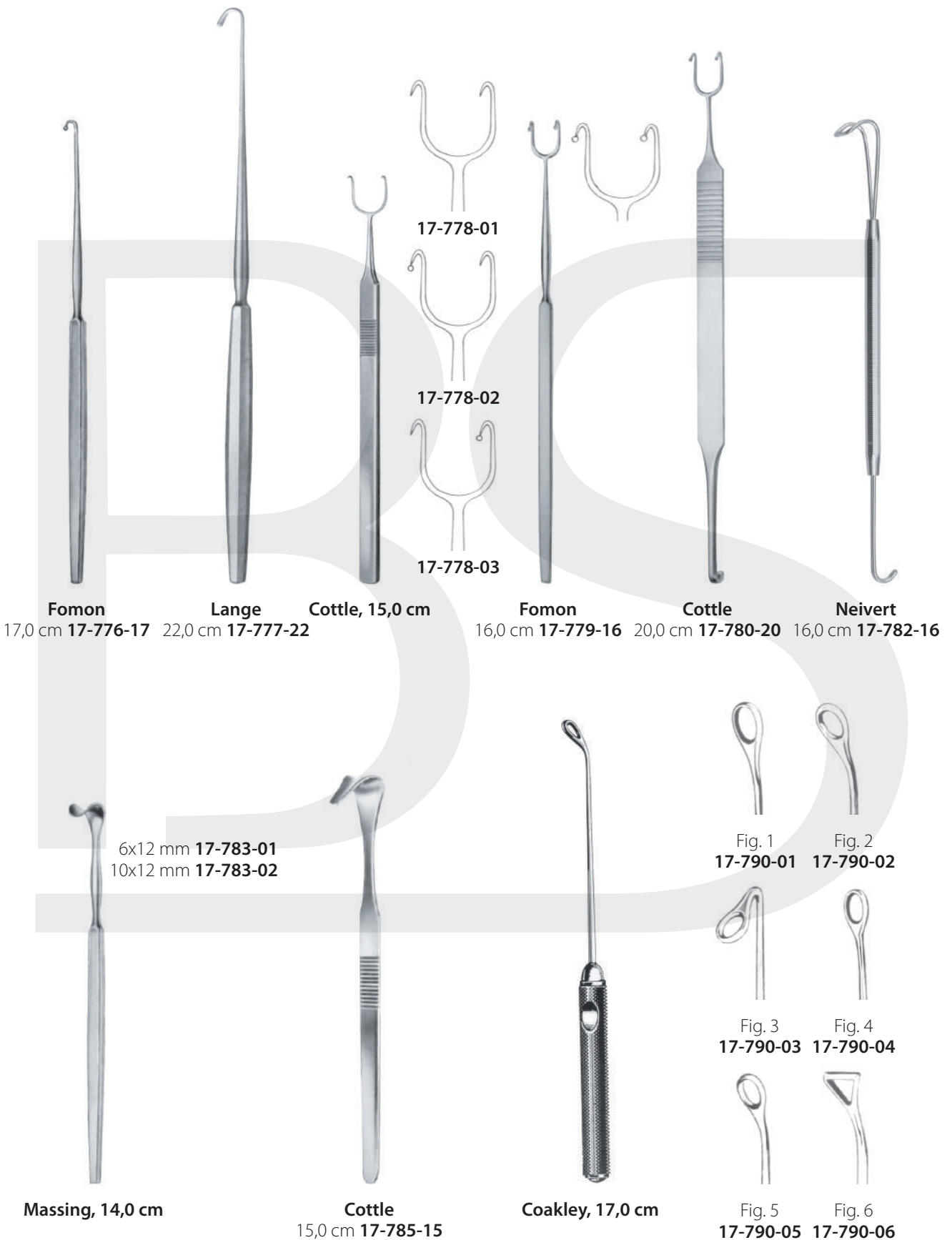

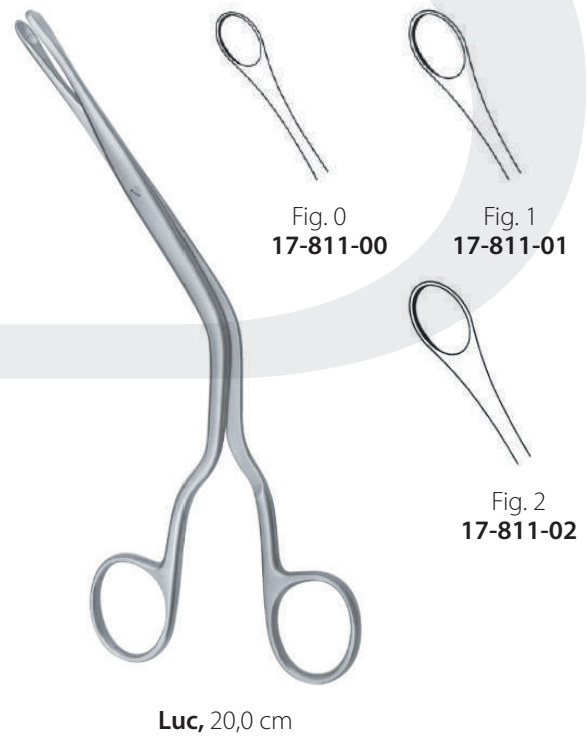
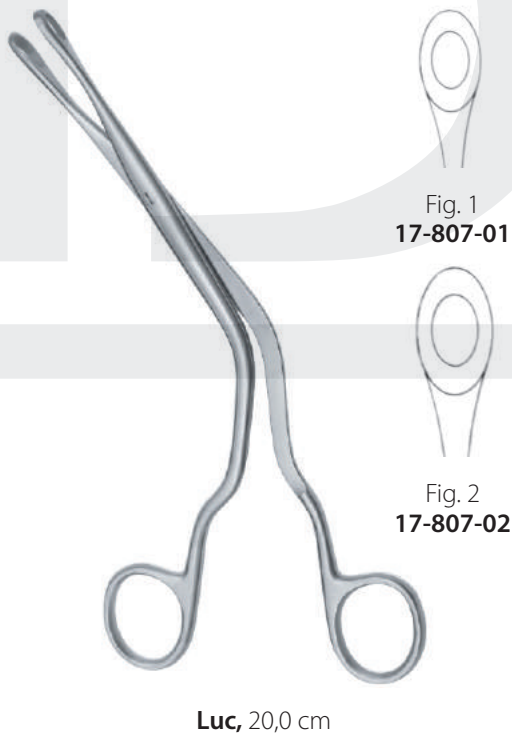
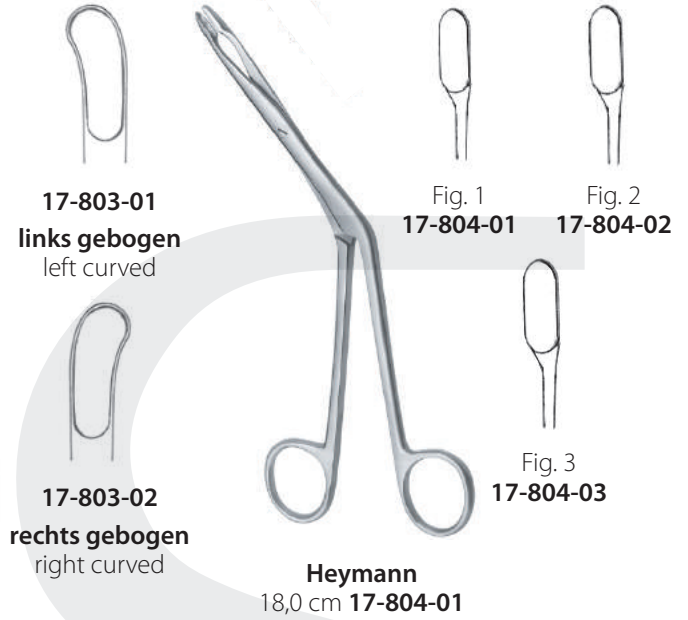
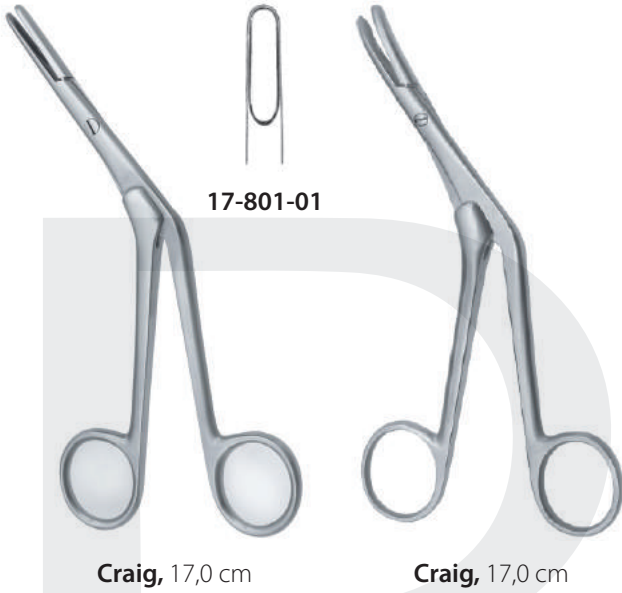



Brünings, 19,0 cm



Fig. 1
17-813-01



Fig. 2
17-813-02



Fig. 3
17-813-03



Fig. 4
17-813-04

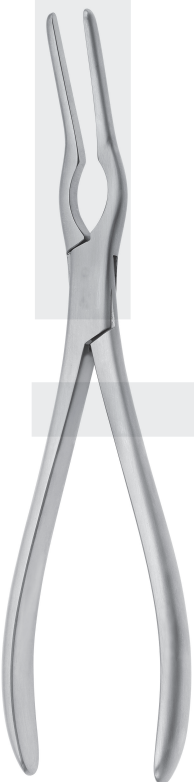

Ash
22,0 cm **17-825-22**



Cottle-Walsham, 22,0 cm



Fig. 1
17-826-01
gerade
straight



Fig. 2
17-826-02
links
left



Fig. 3
17-826-03
rechts
right



Kressner, 22,0 cm



3,0 mm
17-829-03



4,0 mm
17-829-04

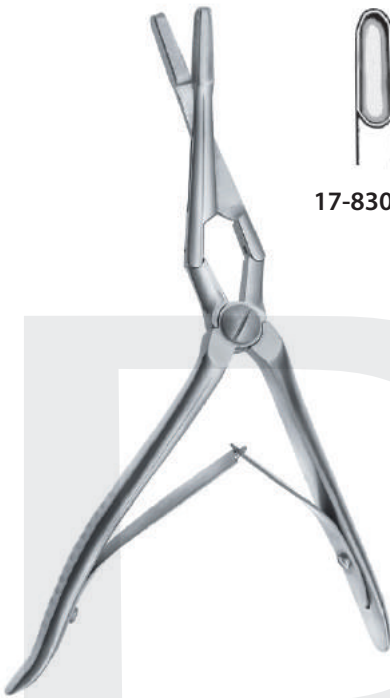

Middleton-Jansen, 19,0 cm



17-830-01



17-830-03

durchschneidend
through-cutting

gezahnt
serrated



Caplan
20,0 cm **17-841-20**

gezahnt
serrated



Killian
21,0 cm **17-843-21**













Rubin
21,0 cm **17-845-21**

kurze Maulöffnung
short jaw opening



Blakesley
extra fein
very delicate

Blakesley Nasenzangen Blakesley Nasal Forceps		 3,0 mm	 3,5 mm	 4,2 mm	
 gerade straight		17-870-30	17-870-35	17-870-42	
 45°		17-871-30	17-871-35	17-871-42	
Blakesley Durchschneidezangen Blakesley Cleaving Forceps		 2,2 mm	 2,5 mm	 3,0 mm	 3,7 mm
	Schnittbreite bit	2,2 mm	2,5 mm	3,0 mm	3,7 mm
 gerade straight		17-880-22	17-880-25	17-880-30	17-880-37
 45°		17-881-22	17-881-25	17-881-30	17-881-37

HNO - Ohr Instrumente
ENT - Ear Instruments

18





Hartmann, mit Dämpfer
with clamps

- c 64 **18-000-03**
- c 128 **18-000-04**
- c1 256 **18-000-05**

Hartmann

- c 128 **18-001-01**
- c1 256 **18-001-02**
- c2 512 **18-001-03**
- c3 1024 **18-001-04**
- c4 2048 **18-001-05**
- c5 4096 **18-001-06**

Lucae

- c 128 **18-004-01**
- c1 256 **18-004-02**
- c2 512 **18-004-03**
- c3 1024 **18-004-04**
- c4 2048 **18-004-05**
- c5 4096 **18-004-06**

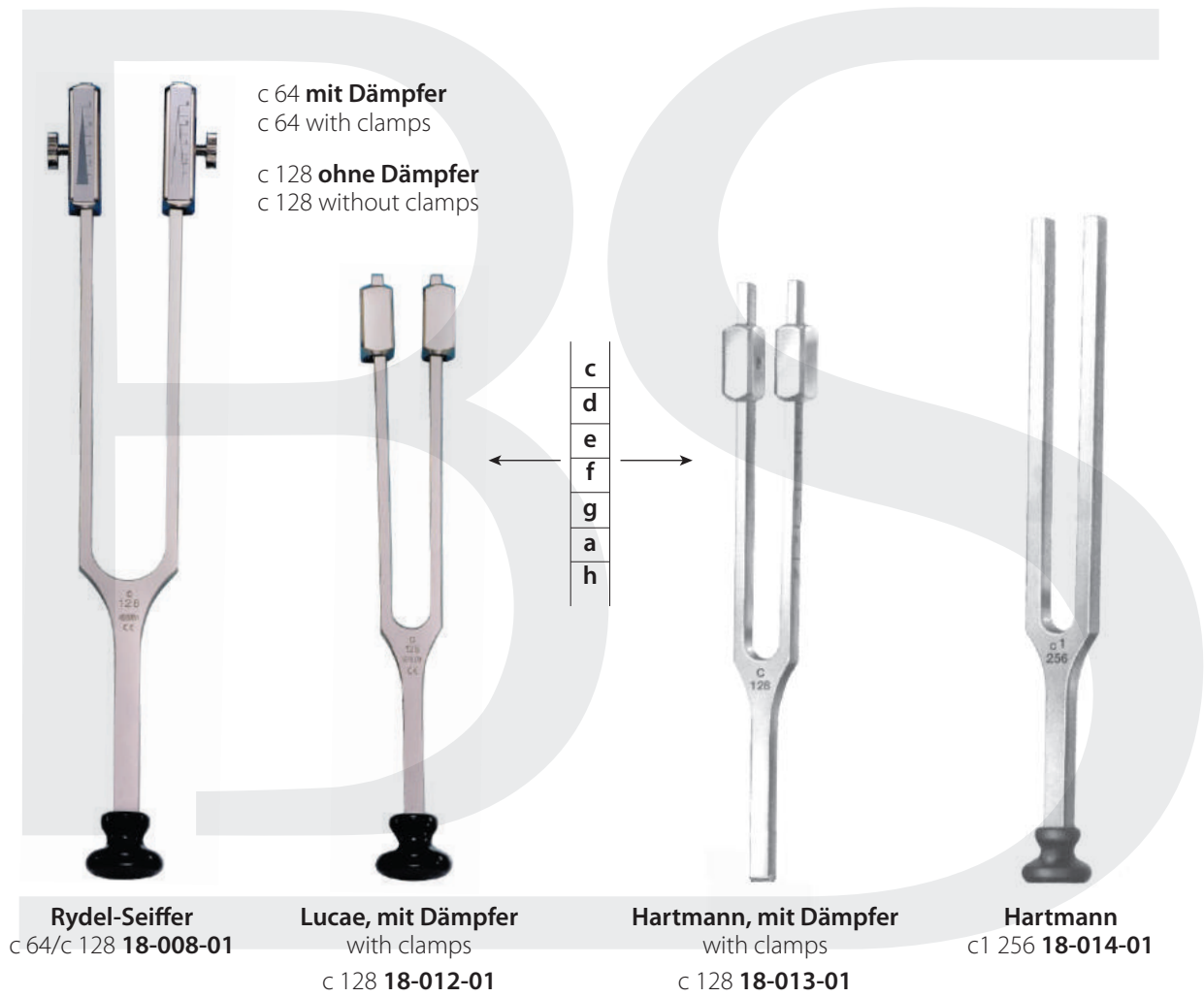



18-034-18

18-034-21

18-034-23

Politzer komplett/complete
18-034-00

mit 3 Nasenoliven 18-034-18
with nasal olives 18-034-21
18-034-23

Gummibirne mit 18-034-23
Einsteckkonus
Rubber Bulb with Metal
Connector

Einsteckkonus 18-034-03
Metal Connector



Gummibirne
Rubber Bulb
18-034-50



Kabierske
komplett/complete
18-036-00

mit 3 Kanülen und Gummiball
with 3 cannulas and rubber bulb



18-042-01
10 ml

komplett mit Teller und 2 Ansätzen
complete with protection disc and 2 tips

18-044-05
50 ml

komplett mit Teller und 2 Ansätzen
complete with protection disc and 2 tips

18-044-10
100 ml

komplett mit Teller und 2 Ansätzen
complete with protection disc and 2 tips

∅ = Innendurchmesser
∅ = inside diameter

Chromnickelstahl
stainless steel



Politzer
Kinder/children

18-100-00
18-100-02
18-100-03
18-100-04

Satz / Set
∅ 2 mm
∅ 3 mm
∅ 4 mm

Chromnickelstahl
stainless steel



Hartmann

18-102-12
18-102-18
18-102-32
18-102-40

Satz / Set
∅ 1,8 mm
∅ 3,2 mm
∅ 4,0 mm

18-102-13
18-102-45
18-102-55
18-102-65

Satz / Set
∅ 4,5 mm
∅ 5,5 mm
∅ 6,5 mm

Chromnickelstahl
stainless steel



Toynbee

18-108-00
18-108-05
18-108-06
18-108-07

Satz / Set
∅ 5,5 mm
∅ 6,5 mm
∅ 7,5 mm



18-140-00

Otoskopbesteck komplett in Etui bestehend aus:
1 Griff Typ C für 2 Batterien oder 1 Accu (ohne Batterien/Accu)
1 Otoskopkopf mit Halogenbirne 2,5 V je 1 wiederverwendbarer Ohrtrichter ∅ 2,0 mm, 3,0 mm, 4,0 mm und 5,0 mm, schwarz
je 3 Einwegohrtrichter ∅ 2,0 mm und 4,0 mm, blau
1 Operationslinse, 4-fach vergrößernd
1 Ersatzbirnchen, Halogen 2,5 V

Otoscopic instruments complete in case consisting of:
1 battery handle type C (without batteries)
1 otoscope head with halogen bulb 2,5 V
1 each reusable ear specula ∅ 2,0 mm, 3,0 mm, 4,0 mm and 5,0 mm black
3 each disposable ear specula ∅ 2,0 mm and 4,0 mm, blue
1 magnifying lens for operations 4 x
1 spare bulb, halogen, 2,5 V

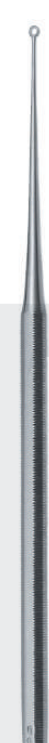

stumpf/blunt

Fig. 000	Fig. 00	Fig. 0	Fig. 1	Fig. 2	Fig. 3	Fig. 4
18-150-01	18-150-02	18-150-03	18-150-04	18-150-05	18-150-06	18-150-07

stumpf/blunt

18-151-01	18-151-02	18-151-03	18-151-04	18-151-05	18-151-06	18-151-07

scharf/sharp

18-152-01	18-152-02	18-152-03	18-152-04	18-152-05	18-152-06	18-152-07

scharf/sharp

18-153-01	18-153-02	18-153-03	18-153-04	18-153-05	18-153-06	18-153-07

Buck
18-150-01 - 18-153-07
17,0 cm

Langenbeck 13,0 cm 18-155-13	Fig. 1 18-156-01	Fig. 2 18-156-02	Fig. 3 18-156-03	Fig. 1 18-159-01	Fig. 2 18-159-02	Fig. 3 18-159-03	Fig. 1 18-160-01	Fig. 2 18-160-02	Fig. 3 18-160-03	Fig. 4 18-160-04
	Billeau, 16,0 cm			Weber-Loch			Shapleigh, 13,0 cm			

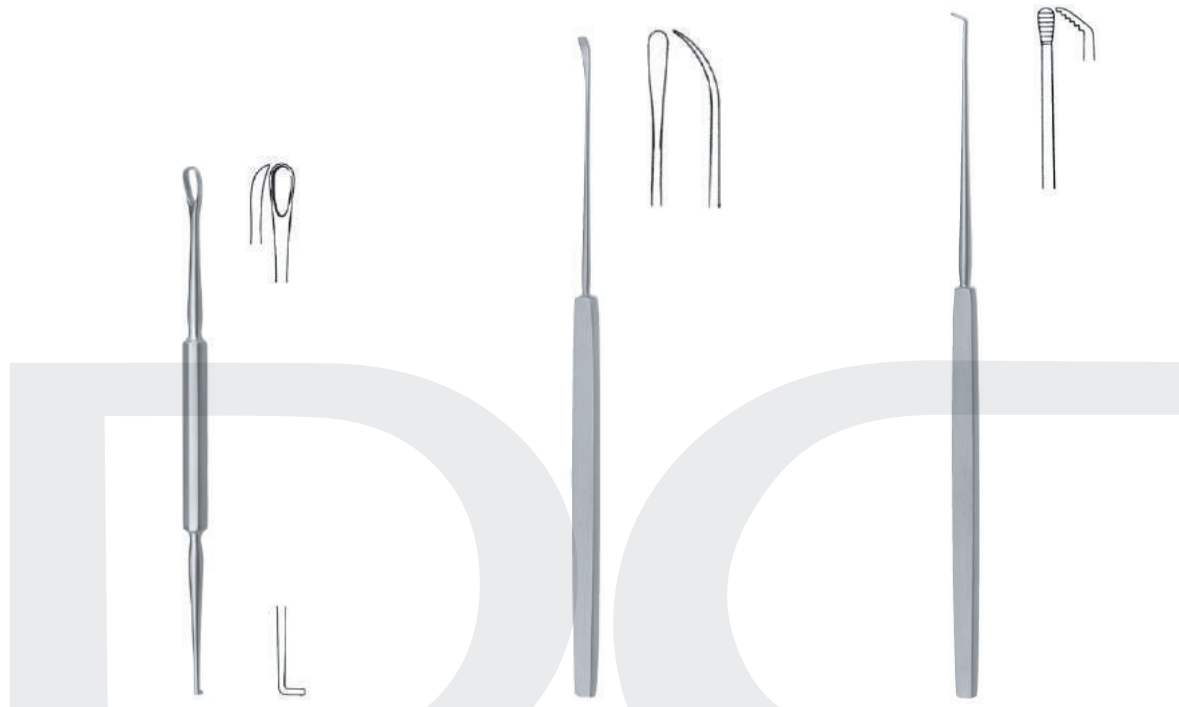

Gross
12,0 cm 18-165-12

Zaufal
16,0 cm 18-167-16

Moldenhauer
16,5 cm 18-169-16

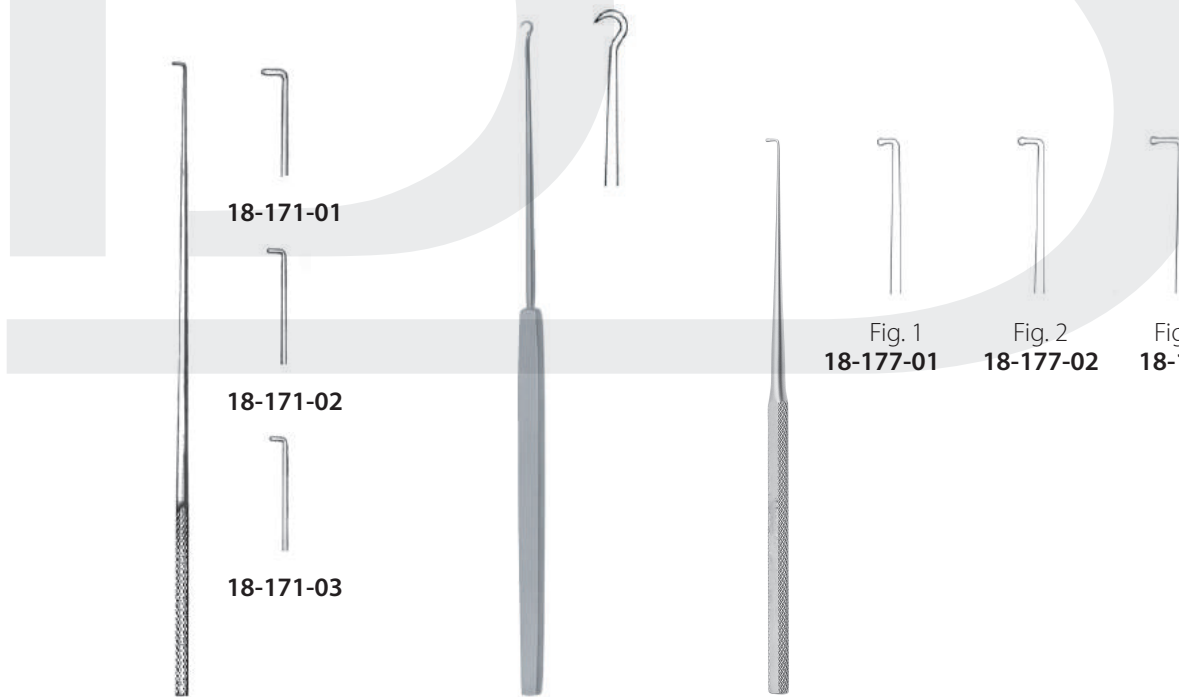

18-171-01

18-171-02

18-171-03

Day, 16,0 cm

Hartmann
16,0 cm 18-175-16

Fig. 1
18-177-01

Fig. 2
18-177-02

Fig. 3
18-177-03

Lucae, 14,0 cm

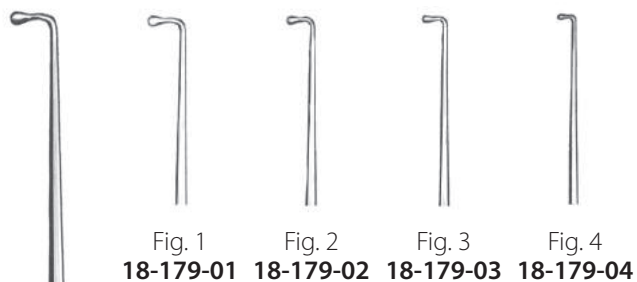

Quire
10,5 cm 18-200-09

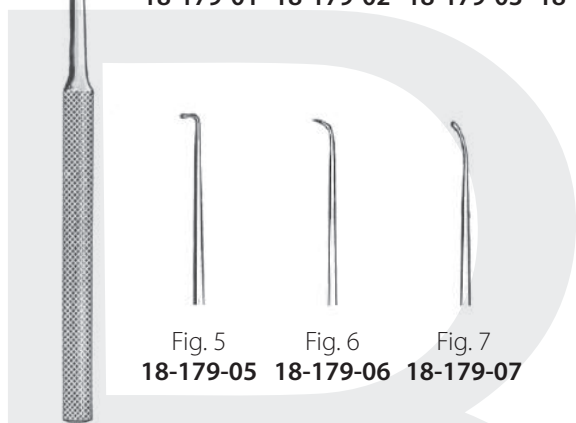

Wagner, 15,0 cm



Buck
10,5 cm 18-202-09

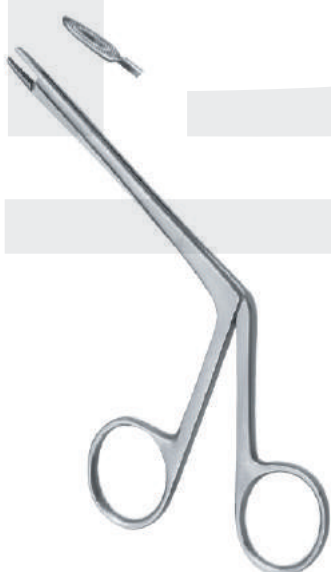

Littauer
12,0 cm 18-204-12



Hartmann



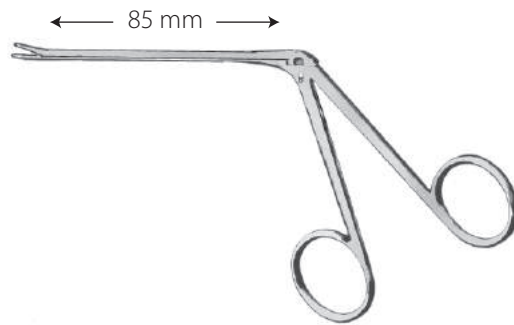

Hartmann
8,5 cm **18-210-08**



Hartmann-Wullstein
8,5 cm **18-212-08**



Hartmann
8,5 cm **18-214-08**
14,0 cm **18-214-14**



Hartmann
8,5 cm **18-216-08**



Hartmann
8,5 cm **18-222-08**



Hartmann
8,5 cm **18-224-08**



Hartmann
Ø 2,0 mm **18-226-01**
Ø 2,5 mm **18-226-02**
Ø 3,0 mm **18-226-03**



Hartmann
8,5 cm **18-228-06**



Struempel
8,5 cm **18-230-08**



Hartmann
8,5 cm **18-232-08**
durchschneidend

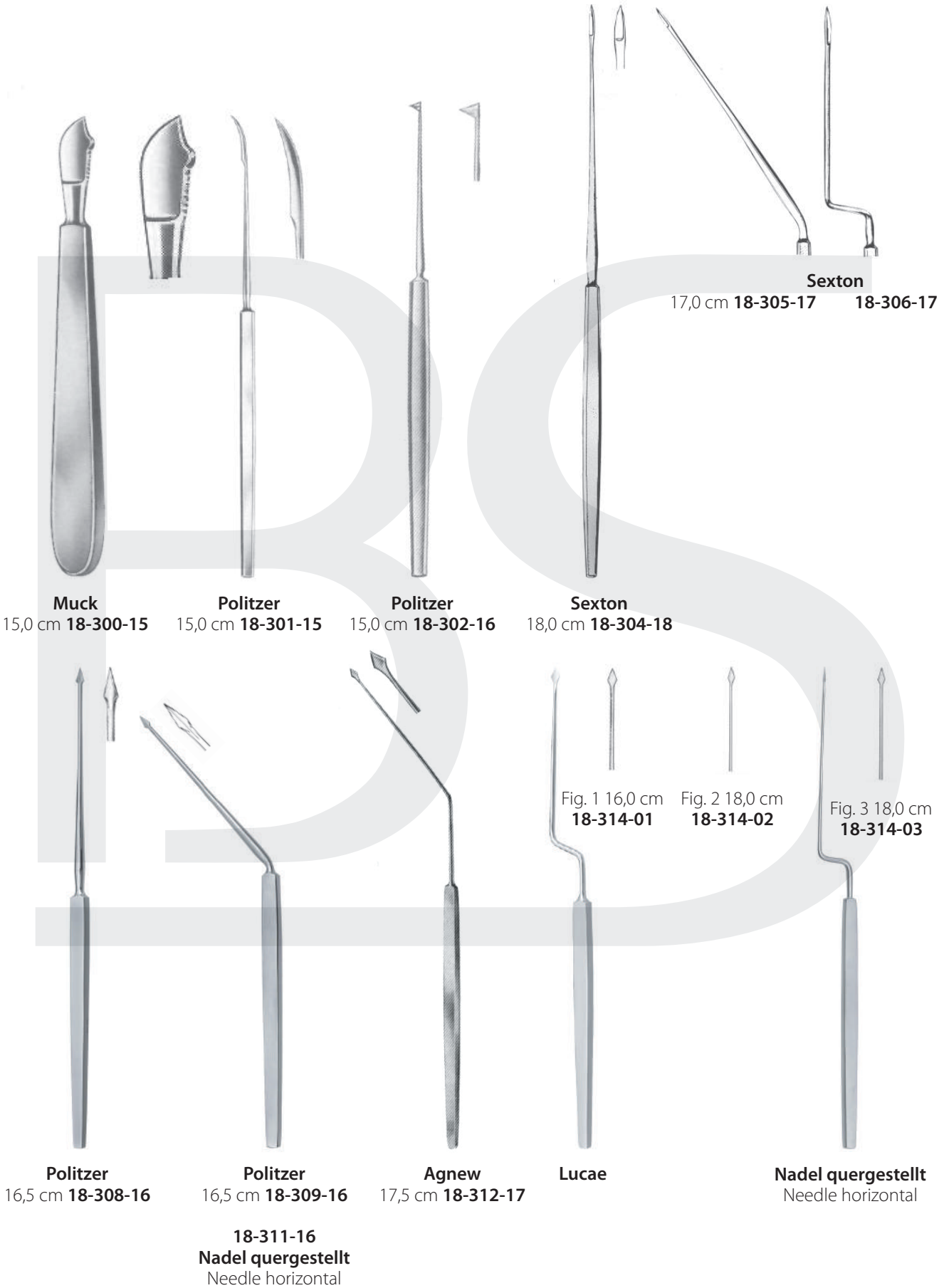

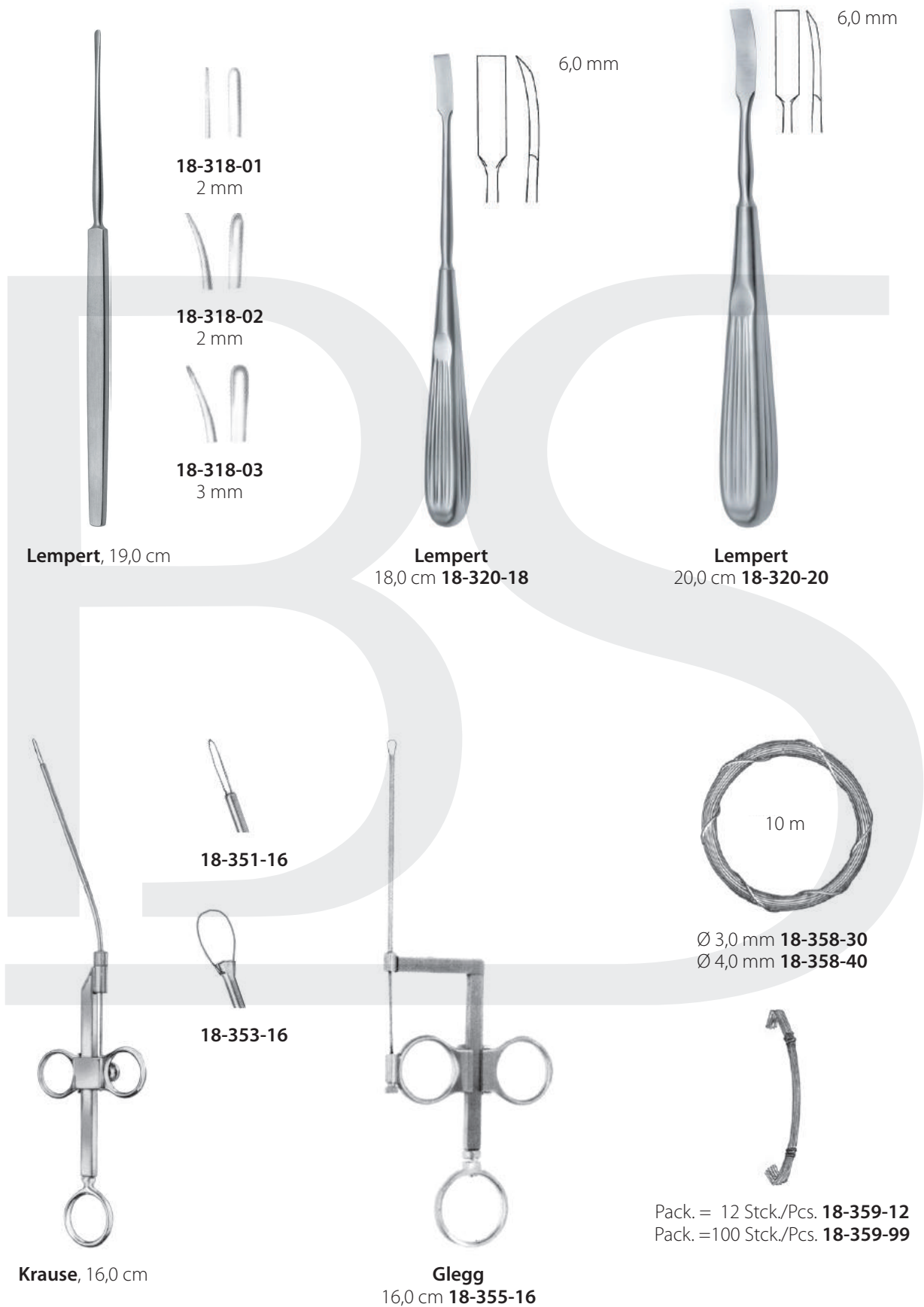

Mikro-Ohrzängchen
Micro Ear Forceps

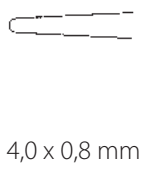

Maulteil glatt
smooth jaw

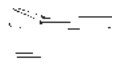

gerade/straight
18-400-01

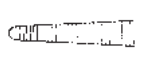

Maulteil gerieft
serrated jaw

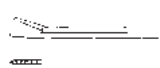

gerade/straight
18-400-02

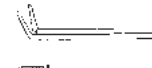

aufgebogen/curved up
18-400-03



rechts gebogen/curved right
18-400-04



links gebogen/curved left
18-400-05

← 80 mm →

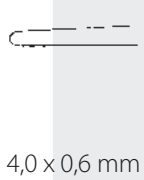

Maulteil glatt
smooth jaw

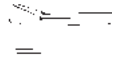

gerade/straight
18-402-01



Maulteil gerieft
serrated jaw



gerade/straight
18-402-02

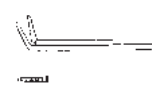
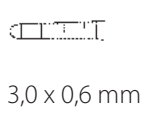

aufgebogen/curved up
18-402-03

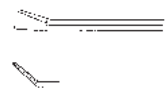

rechts gebogen/curved right
18-402-04

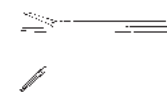

links gebogen/curved left
18-402-05





3,5 x 0,6 mm
Maulteil glatt
smooth jaw

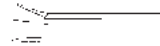

gerade/straight
McGee
18-404-01

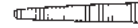

3,5 x 0,6 mm
Maulteil gerieft
serrated jaw



gerade/straight
McGee
18-404-02

80 mm



1,0 x 0,9 mm

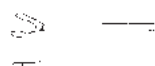

gerade/straight
18-406-01

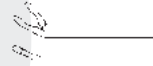

aufgebogen/curved up
18-406-02

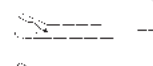

rechts gebogen/curved right
18-406-03



links gebogen/curved left
18-406-04

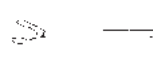

gerade/straight
18-406-11

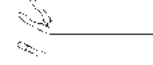

aufgebogen/curved up
18-406-12

sehr fein/very delicate

0,6 x 0,5 mm



gerade/straight
18-408-01



aufgebogen/curved up
18-408-02

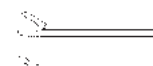

rechts gebogen/curved right
18-408-03



links gebogen/curved left
18-408-04

Mikro-Ohrscheren und Drahtbiegezängchen

Micro Ear Scissors and Wire closure Forceps

Bellucci

4,0 x 0,8 mm

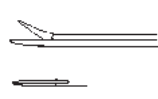

gerade/straight
18-412-01

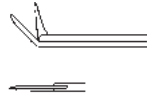

aufgebogen/curved up
18-412-02

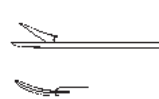

rechts gebogen/curved right
18-412-03

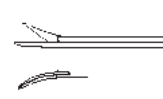

links gebogen/curved left
18-412-04

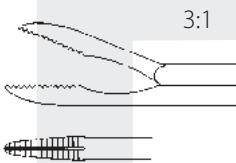
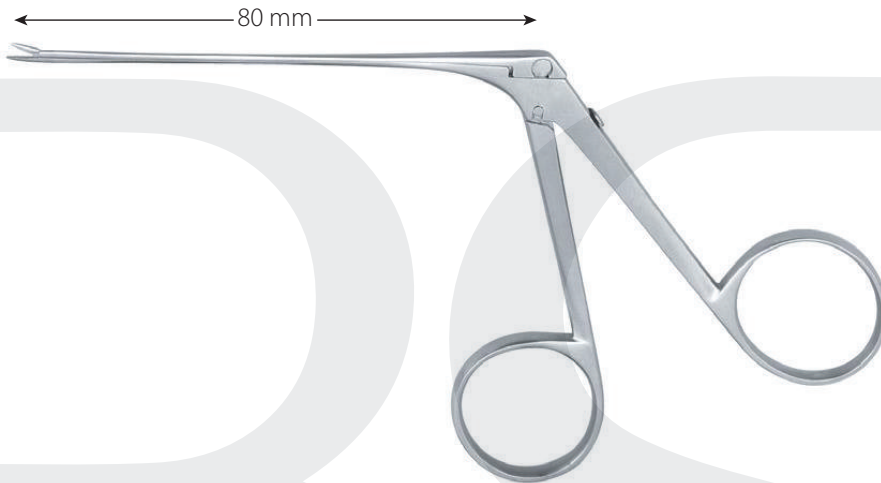

3:1

Maulteil gerieft
serrated jaw

Greven Drahtbiegezängchen

Wire closure Forceps

gerade/straight
18-420-01

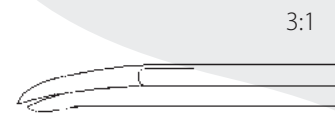

3:1

Schuhknecht

abwärts gebogen
downwards curved
18-420-02

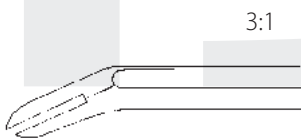

3:1

McGee Drahtbiegezängchen

Wire closure Forceps

abwärts gebogen
downwards curved
3,5 x 0,8 mm
18-422-01

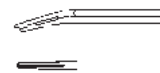

abwärts gebogen
downwards curved
6,0 x 0,8 mm
18-422-02

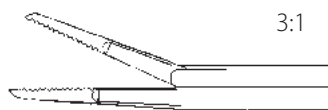

3:1

Juers

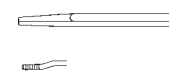



links gebogen/curved left
18-424-01

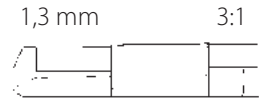

rechts gebogen/curved right
18-424-02



gerade abwarts/
straight downwards
18-426-01

gerade aufwarts/
straight upwards
18-426-02

rechts/
right
18-426-03

links /
left
18-426-04

Fuller, Einfuhrungszangchen
Introduction Forceps
18-428-01

House-Dieter
Hammerkop fzangchen
Malleus Nipper



gerade, spitz
straight sharp
18-454-01

aufgebogen, spitz
curved up, sharp
18-454-02

links gebogen, spitz
curved left, sharp
18-454-03

rechts gebogen, spitz
curved right, sharp
18-454-04

Bellucci

Dieter



18-456-01



18-456-02

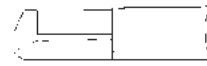

Mc Gee
Drahtbiegezängchen
Wire closure Forceps



18-458-01
Maul 3,0 mm
jaw 3,0 mm



18-458-02
Maul 5,0 mm
jaw 5,0 mm



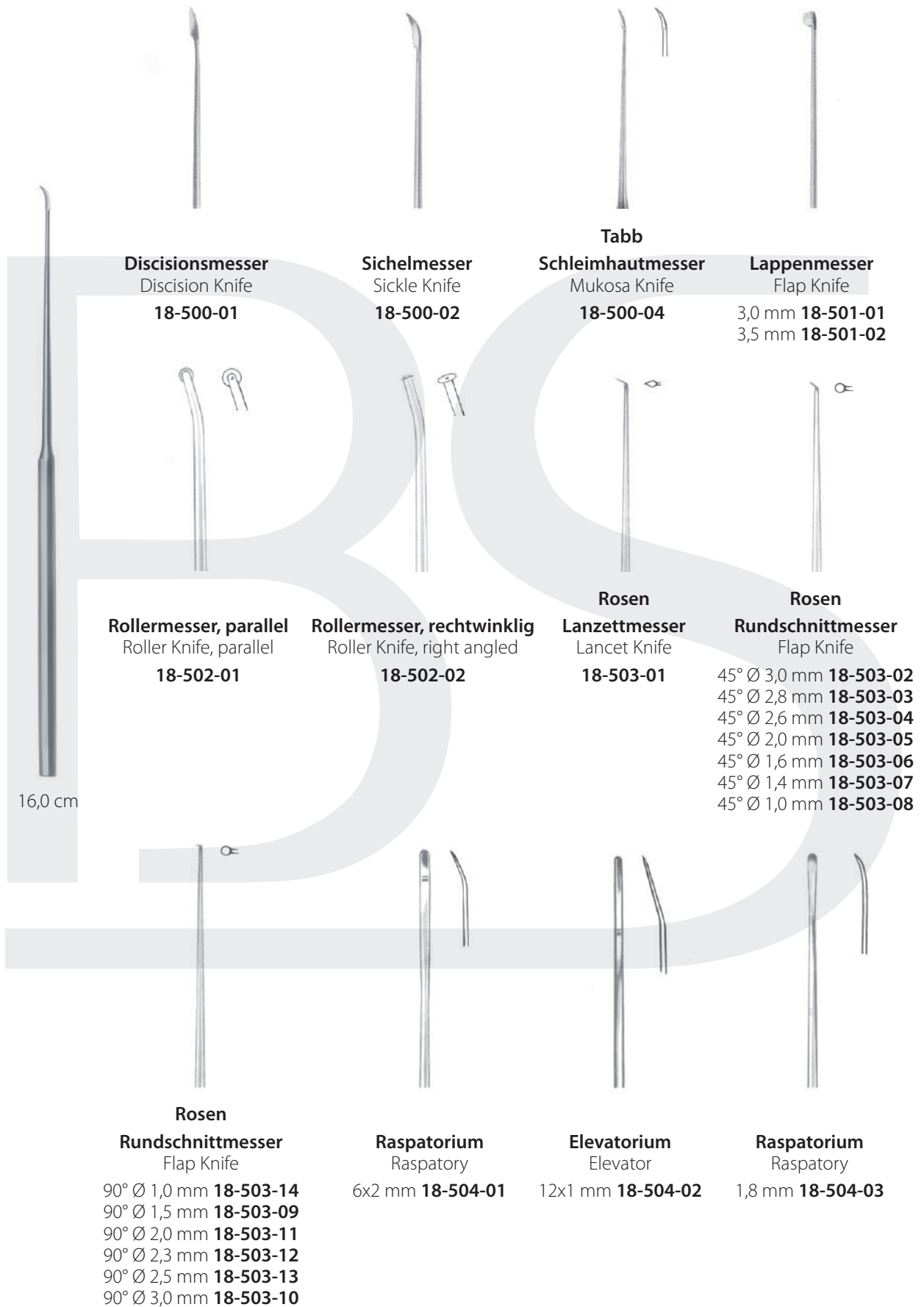

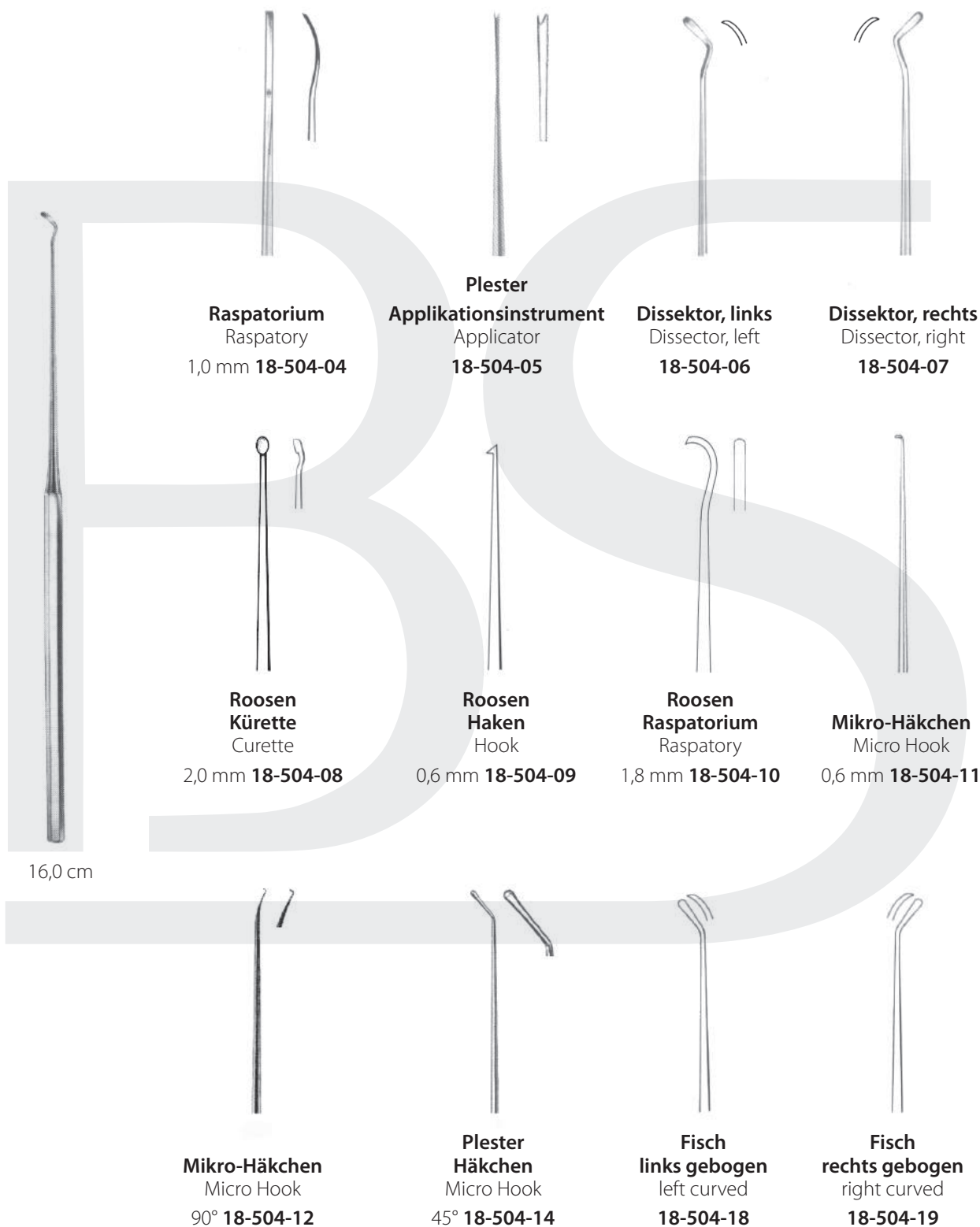



Fisch

gerade / straight **18-505-01**
gebogen / curved **18-501-02**



House

3,5 mm **18-506-35**
4,0 mm **18-506-40**
4,5 mm **18-506-45**
5,0 mm **18-506-50**



Mikro-Nadel
Micro Needle

18-510-01



Mikro-Nadel
Micro Needle

18-510-02



Mikro-Nadel
Micro Needle

18-510-03



16,0 cm



Mikro-Nadel
Micro Needle

18-510-04



25°

Shambough

0,3 mm **18-510-05**
0,6 mm **18-510-06**
1,0 mm **18-510-07**



45°

Shambough

0,4 mm **18-510-08**
0,6 mm **18-510-09**
0,8 mm **18-510-10**
1,0 mm **18-510-11**
1,2 mm **18-510-54**
1,5 mm **18-510-55**
2,0 mm **18-510-56**
2,5 mm **18-510-57**



90°

Shambough

0,2 mm **18-510-21**
0,6 mm **18-510-68**
0,4 mm **18-510-12**
0,6 mm **18-510-13**
0,8 mm **18-510-14**
1,0 mm **18-510-15**
1,2 mm **18-510-64**
1,5 mm **18-510-65**
2,0 mm **18-510-66**
2,5 mm **18-510-67**



Mikro-Häkchen
Micro Hook

18-510-16



Plester Schaber
Scraper

18-510-17



Gerlach Mikro-Häkchen
Micro Hook

18-510-22



Plester
18-510-23

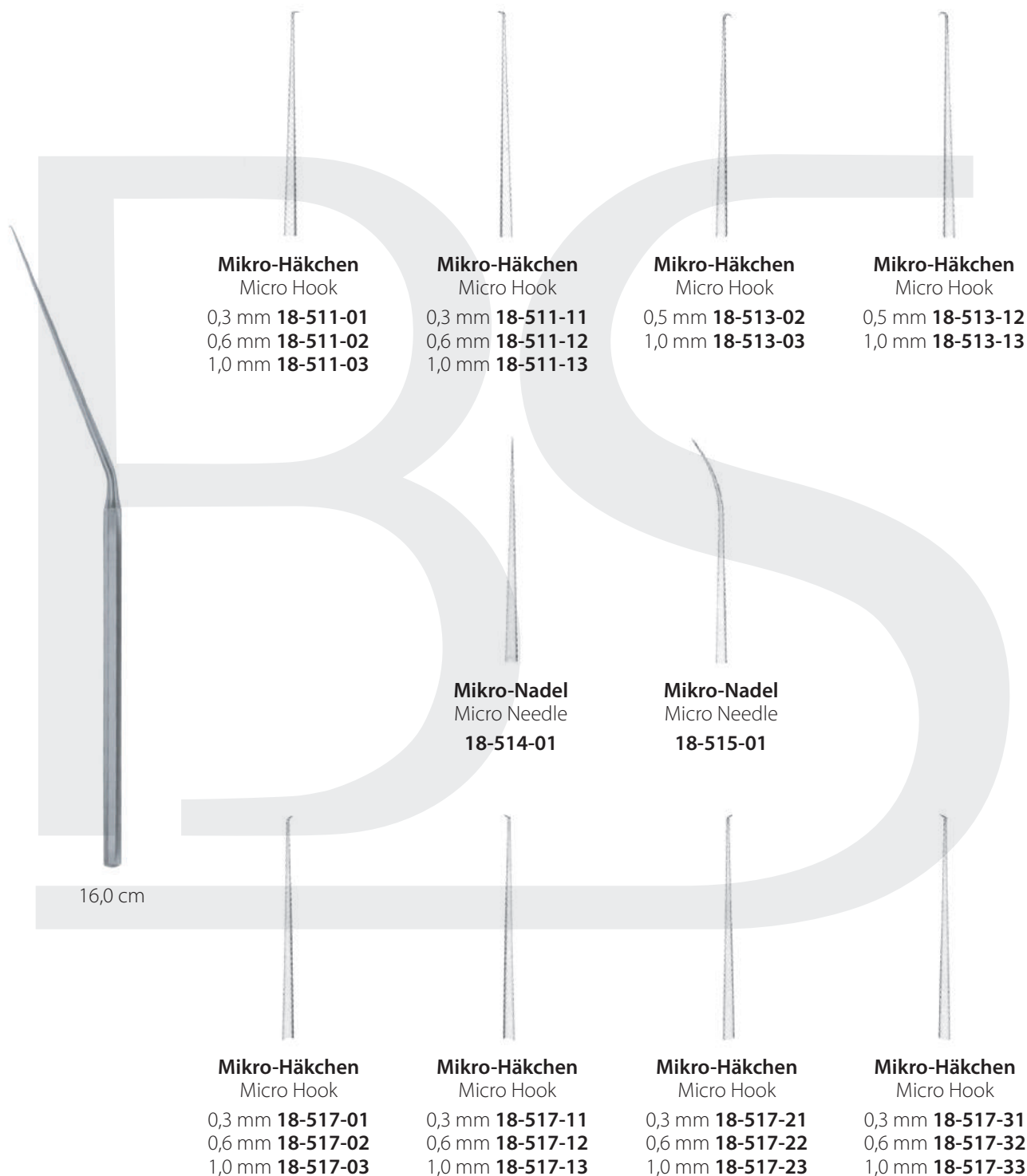



Shea

16,0 cm **18-520-01**



Shea

16,0 cm **18-521-01**



18-522-01

Ø 1,0/1,2 mm



18-522-02

Ø 1,5/1,8 mm



18-522-03

Ø 1,0/1,2 mm



18-522-04

Ø 1,5/1,8 mm



House

17,0 cm **18-522-05**



Heermann
18-530-01



18-530-02



18-530-03



18-530-04



18-530-05



Heermann
18-530-00



Heermann
19,5 cm **18-532-19**

Thorax- und Lungeninstrumente
Thorax and Lung Instruments

21



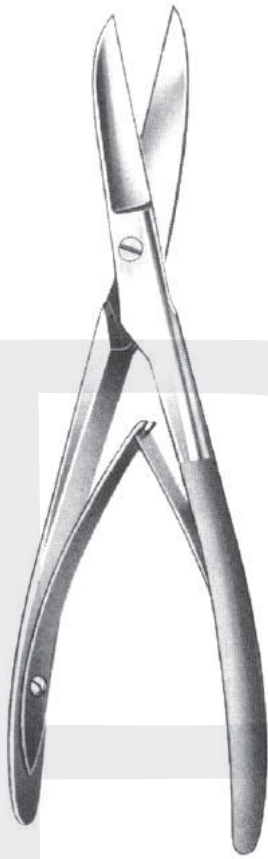

23,0 cm **21-100-23**



22,0 cm **21-101-22**



Gluck
22,0 cm **21-103-22**



Lebsche
24,0 cm **21-109-24**

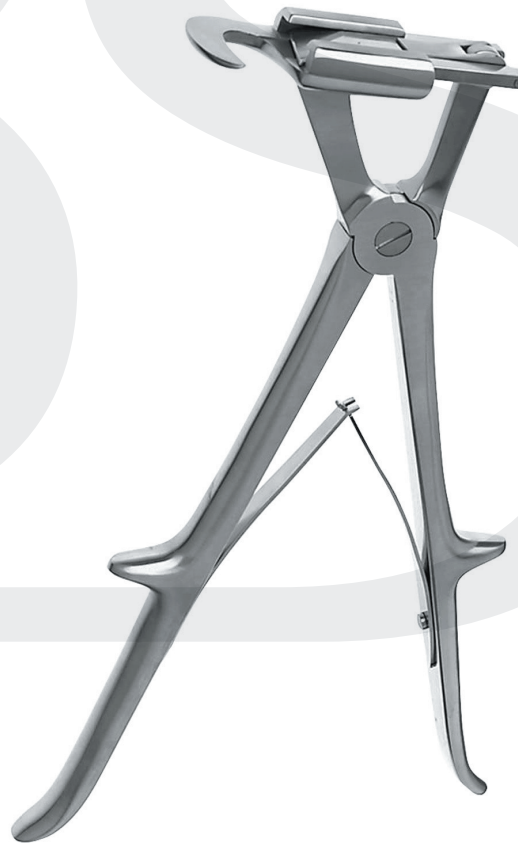

Sauerbruch
24,0 cm **21-110-24**
27,0 cm **21-110-27**



Bethune
34,0 cm 21-111-34



Sauerbruch-Frey
34,0 cm 21-112-37



Brunner
rechte Hand/right hand
32,0 cm **21-113-32**



Brunner
linke Hand/left hand
32,0 cm **21-115-32**



21-119-33



Giertz-Still
25,0 cm **21-117-27**

Abmessung Valven und Sperrer
Measurement of blades and retractor

Größe der Valve
blade size

Ausladung
total spread

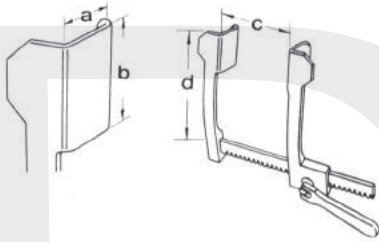

Aluminium



Cooley

		a	b	c	d
21-201-00	mm	12	16	85	55
21-202-00	mm	15	30	115	80
21-203-00	mm	20	45	140	110



Cooley

		a	b	c	d
21-204-00	mm	30	50	185	145



Finocchetto

		a	b	c	d
21-205-00	mm	12	15	70	55
21-206-00	mm	30	30	95	80

Abmessung Valven und Sperrer
Measurement of blades and retractor

Größe der Valve
blade size

Ausladung
total spread

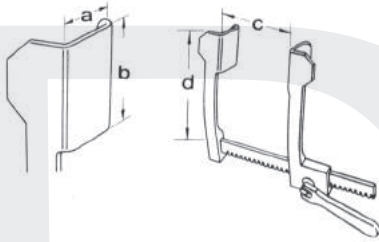

Aluminium



Finocchetto

		a	b	c	d
21-207-00	mm	30	45	140	110
21-208-00	mm	42	62	170	140
21-209-00	mm	73	65	170	140

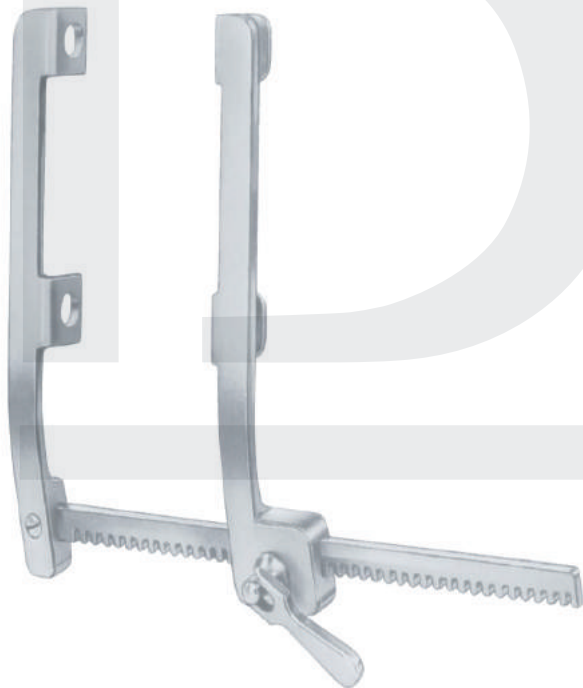

Finocchetto

		a	b	c	d
21-210-00	mm	10	15	120	105

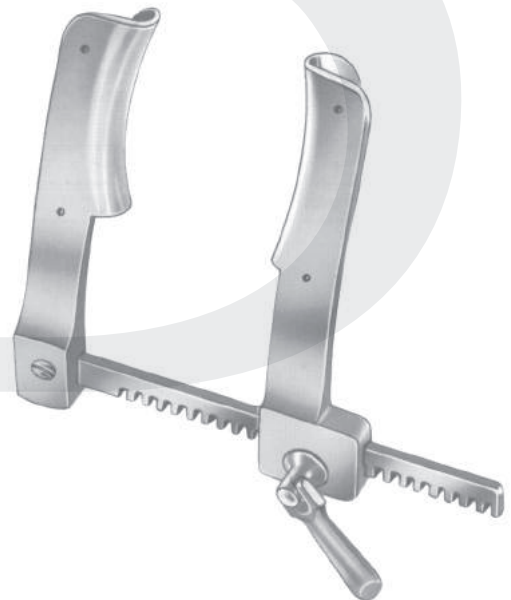

Castaneda

		a	b	c	d
21-211-00	mm	16	30	65	55
21-212-00	mm	12	45	72	80
21-213-00	mm	15	60	100	125

Abmessung Valven und Sperrer
Measurement of blades and retractor

Aluminium

Größe der Valve
blade size

Ausladung
total spread

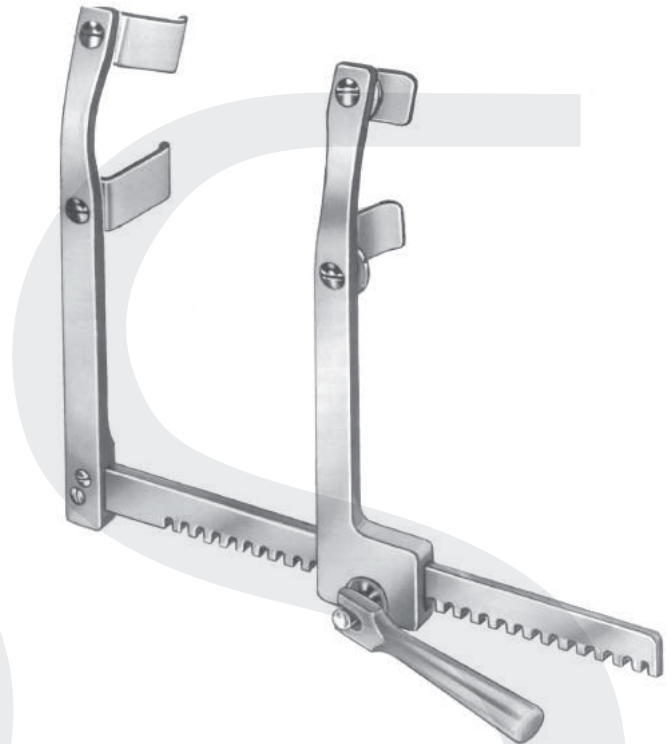
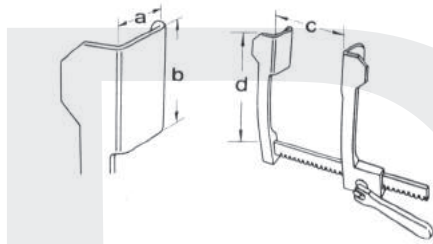

Morse

	a	b	c	d
21-214-00	mm 20	28	210	155

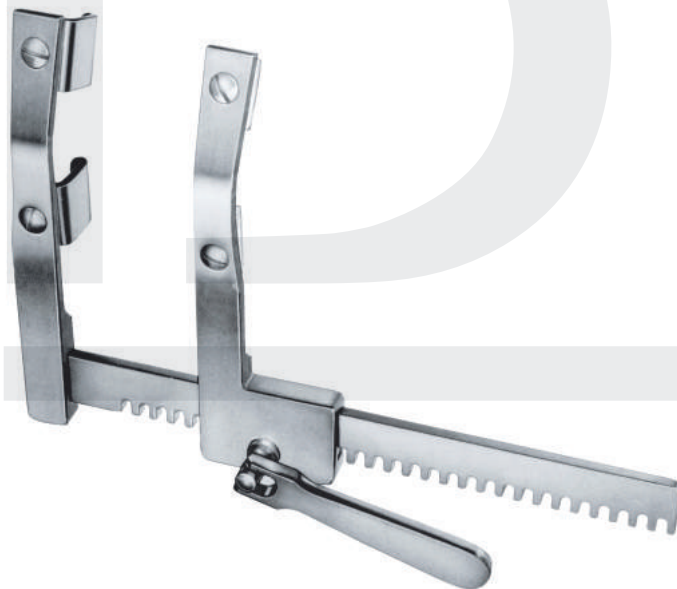

Morse

	a	b	c	d
21-214-00	mm 20	20	155	120

Abmessung Valven und Sperrer
Measurement of blades and retractor

Aluminium

Größe der Valve
blade size

Ausladung
total spread

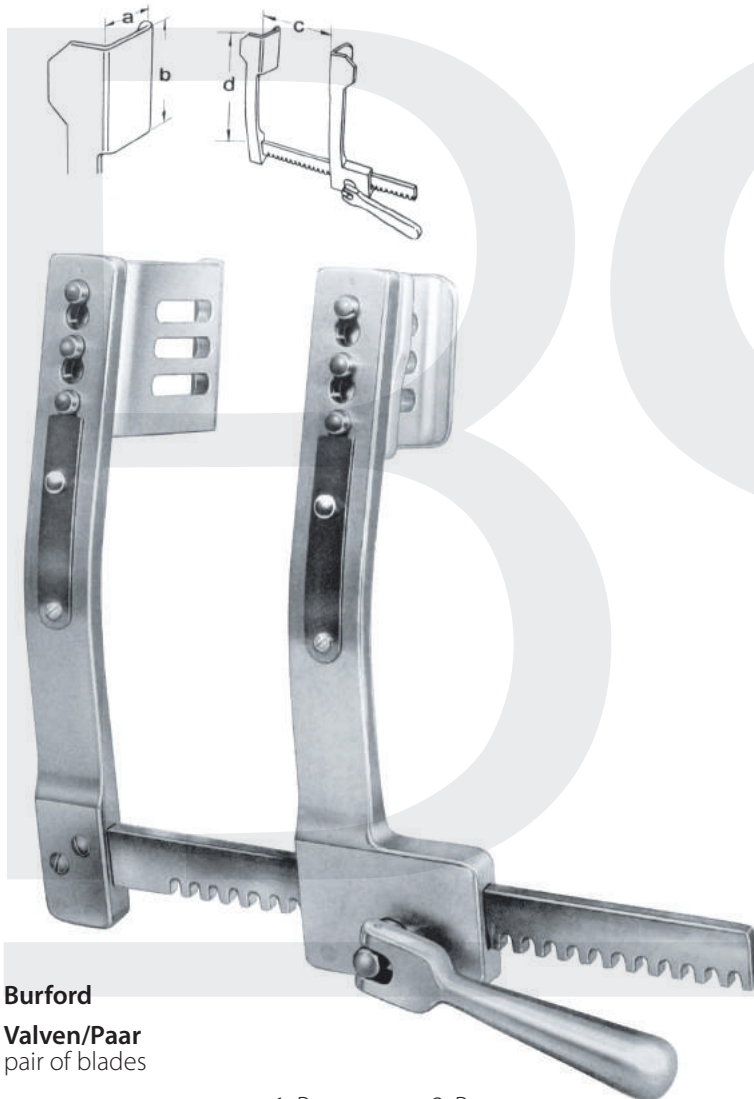

Burford
Valven/Paar
pair of blades

		a	b
21-222-01	mm	30	42
21-222-02	mm	41	42



Burford
Valven/Paar
pair of blades

		a	b
21-223-03	mm	45	62
21-223-04	mm	65	62

Burford
Valven/Paar
pair of blades

		1. Paar 1. Pair		2. Paar 2. Pair		c	d
		a1	b1	a2	b2		
21-222-00	mm	30	42	41	42	130	117
21-223-00	mm	45	62	65	62	165	200
21-224-00	mm	45	62	65	62	250	200
21-225-00	mm	45	62	65	62	290	200
21-227-00	mm	40	67	80	67	220	220

Abmessung Valven und Sperrer
Measurement of blades and retractor

Größe der Valve
blade size

Ausladung
total spread

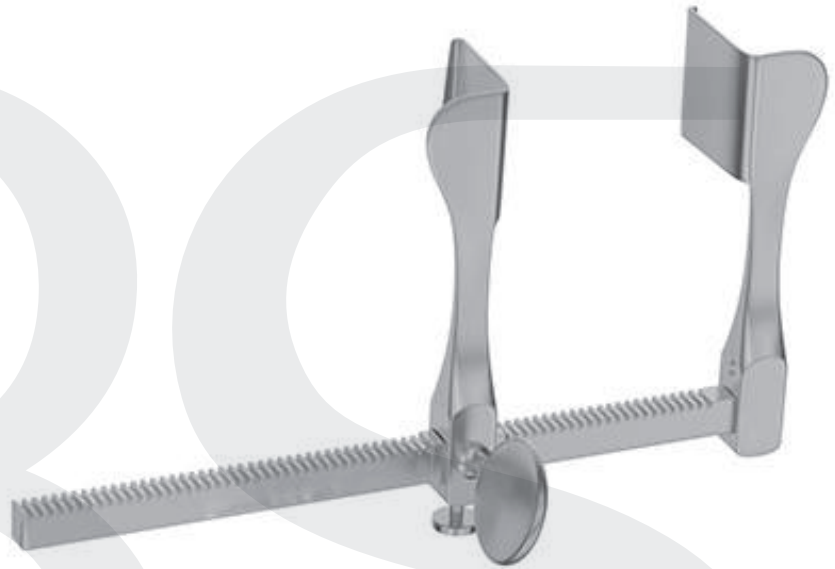
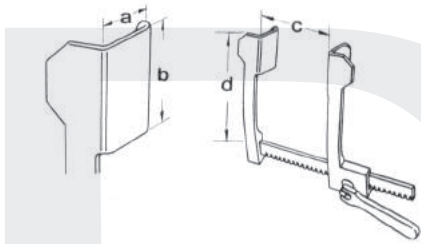

Tuffier

	a	b	c	d
21-231-00	mm 42	45	175	110



Haight

	a	b	c	d
21-233-00	mm 30	30	120	90

Abmessung Valven und Sperrer
Measurement of blades and retractor

Größe der Valve
blade size

Ausladung
total spread

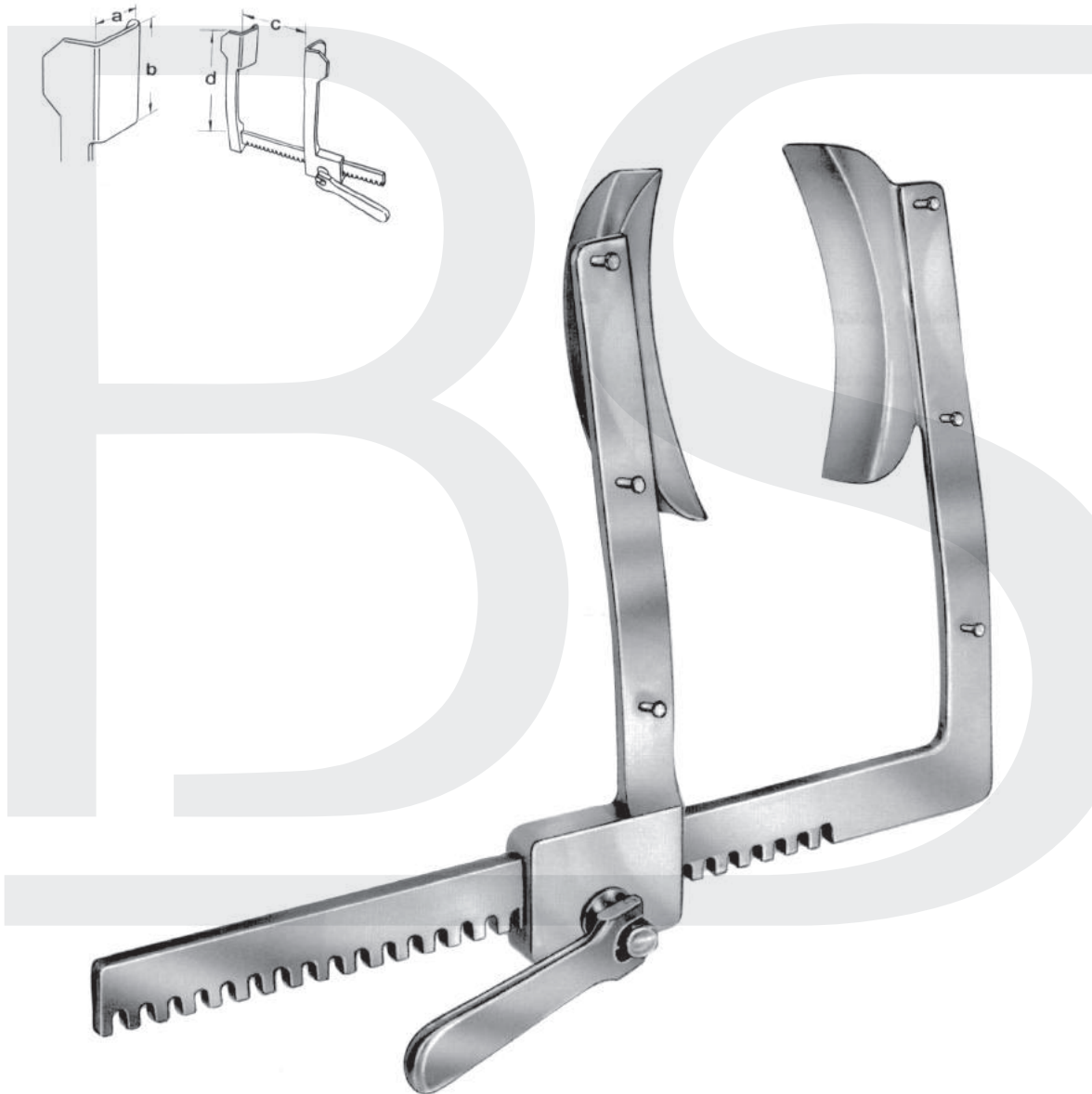

Chevalier		a	b	c	d
21-234-00	mm	27	100	190	185

Abmessung Valven und Sperrer
Measurement of blades and retractor

Größe der Valve
blade size

Ausladung
total spread

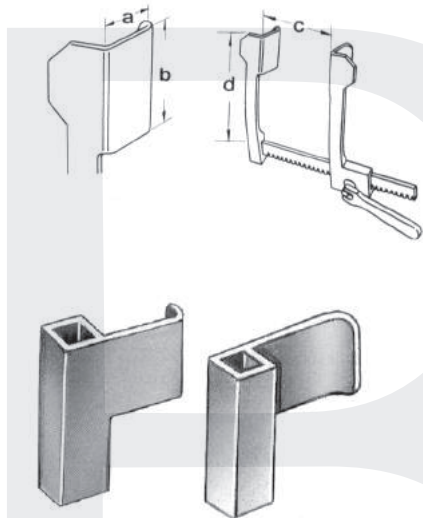

Struck
Valven/Paar
pair of blades

		a1	b1
21-235-01	mm	10	10
21-235-02	mm	10	16
21-235-03	mm	10	20
21-235-04	mm	15	20
21-235-05	mm	20	20

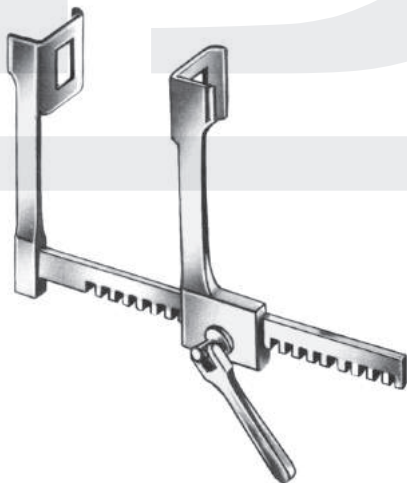

mit 2 Paar Valven/with two pairs of blades

		1. Paar 1. Pair	2. Paar 2. Pair	a	b	c	d
21-237-00	mm	12	15	70	55		

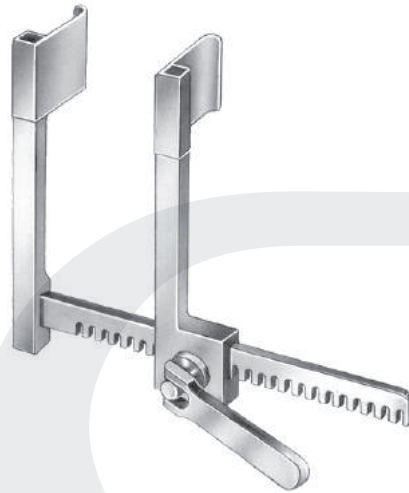

Struck
mit 2 Paar Valven/with two pairs of blades

		1. Paar 1. Pair	2. Paar 2. Pair	a1	b1	a2	b2	c	d
21-235-00	mm	15	20	20	20	70	55		

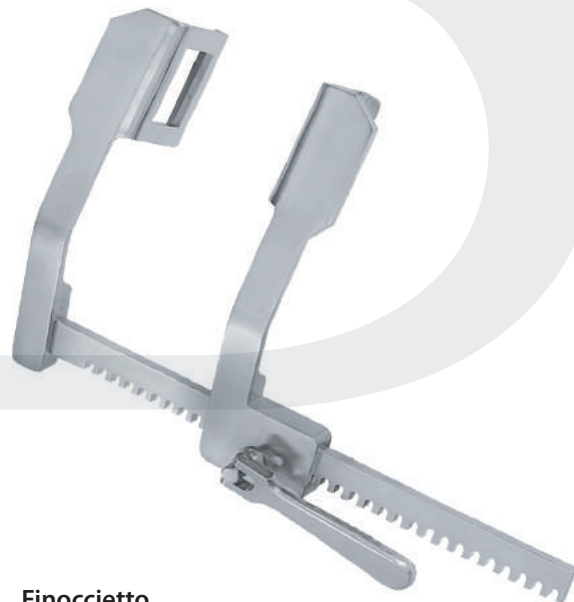

Finoccietto

		a	b	c	d
21-240-00	mm	30	45	140	110
21-241-00	mm	42	62	185	140
21-243-00	mm	73	65	185	140

Abmessung Valven und Sperrer
Measurement of blades and retractor

Größe der Valve
blade size

Ausladung
total spread

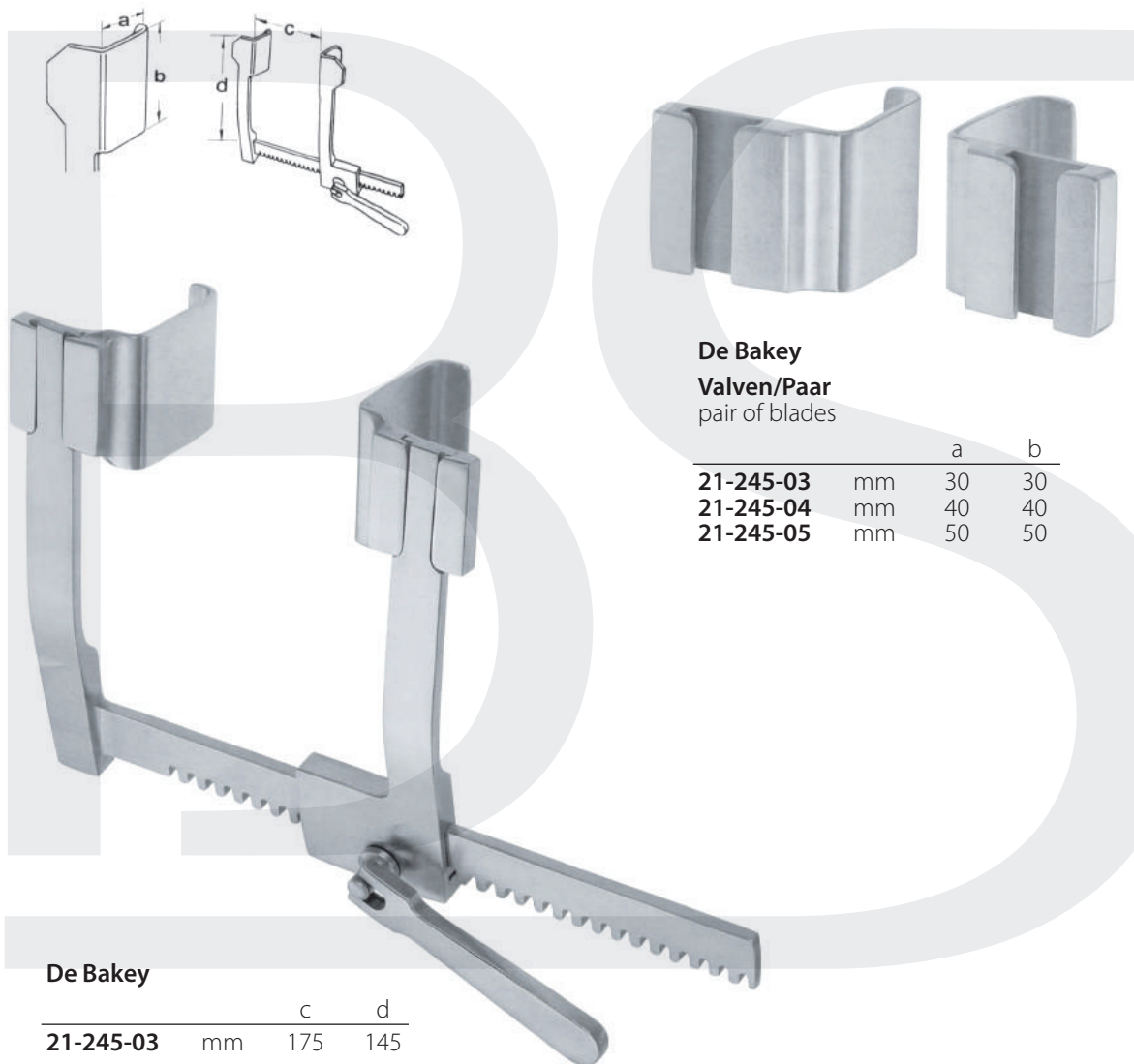

De Bakey
Valven/Paar
pair of blades

		a	b
21-245-03	mm	30	30
21-245-04	mm	40	40
21-245-05	mm	50	50

De Bakey

		c	d
21-245-03	mm	175	145

komplett/complete
bestehend aus/consisting of:

21-245-01 Ripensperrer, allein
Rip Retractor, only

21-245-03 Paar/pair
21-245-04 Paar/pair
21-245-05 Paar/pair

Abmessung Valven und Sperrer
Measurement of blades and retractor

Größe der Valve
blade size

Ausladung
total spread

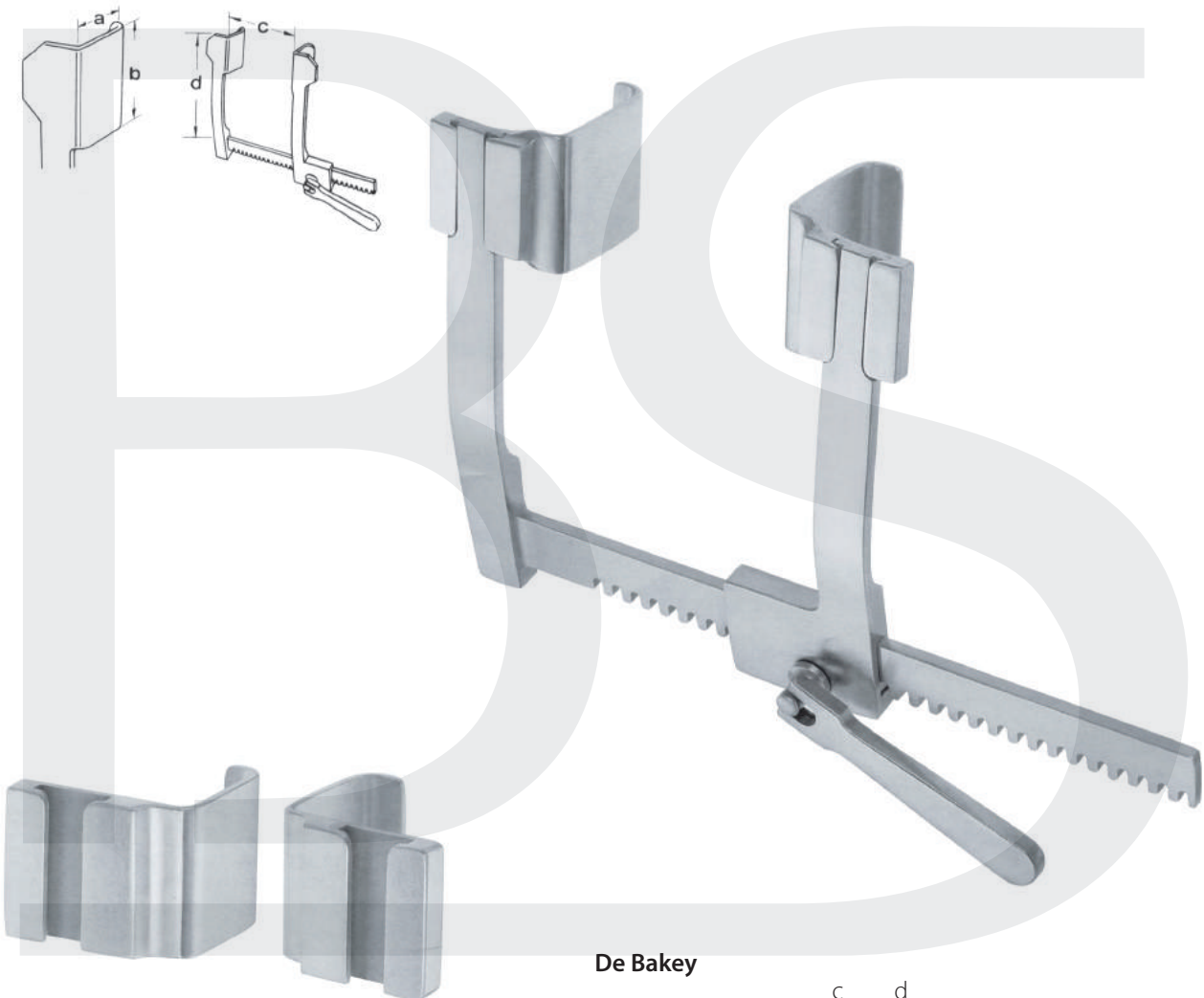

De Bakey
Valven/Paar
pair of blades

		a	b
21-246-02	mm	55	60
21-246-03	mm	60	60
21-246-04	mm	50	80
21-246-05	mm	40	100
21-246-06	mm	80	60

De Bakey

		c	d
21-246-00	mm	200	185

komplett/complete

bestehend aus/consisting of:

21-246-01 Rippensperrer, allein
Rip Retractor, only

21-246-02 Paar/pair

21-246-03 Paar/pair

21-246-04 Paar/pair

21-246-05 Paar/pair

21-246-06 Paar/pair

Abmessung Valven und Sperrer
Measurement of blades and retractor

Größe der Valve
blade size

Ausladung
total spread

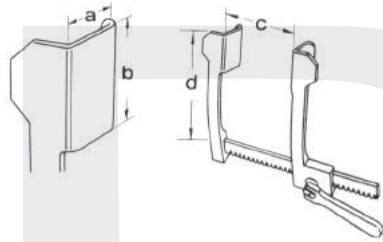

Cooley

	a	b	c	d
21-247-00	mm 20	45	140	110

Cooley

	a	b	c	d
21-248-00	mm 30	50	185	145

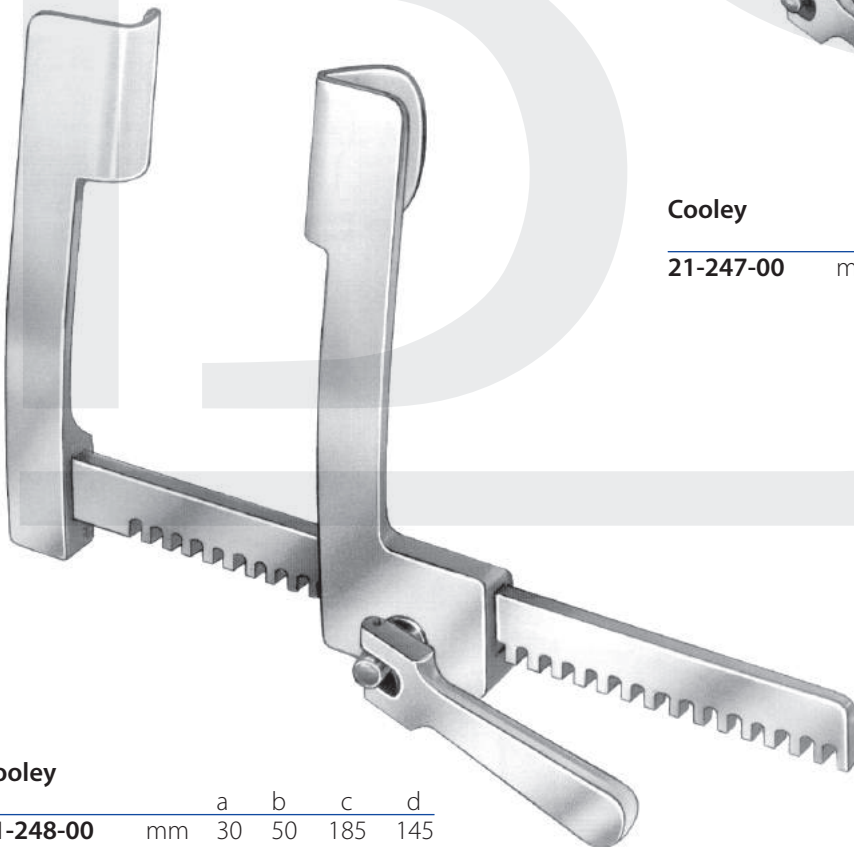

Abmessung Valven und Sperrer
Measurement of blades and retractor

Größe der Valve
blade size

Ausladung
total spread

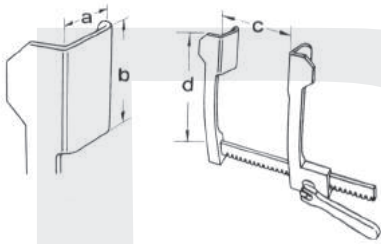

Mercedes
Valven/Paar
pair of blades

		a	b
21-251-02	mm	45	68
21-251-03	mm	78	78

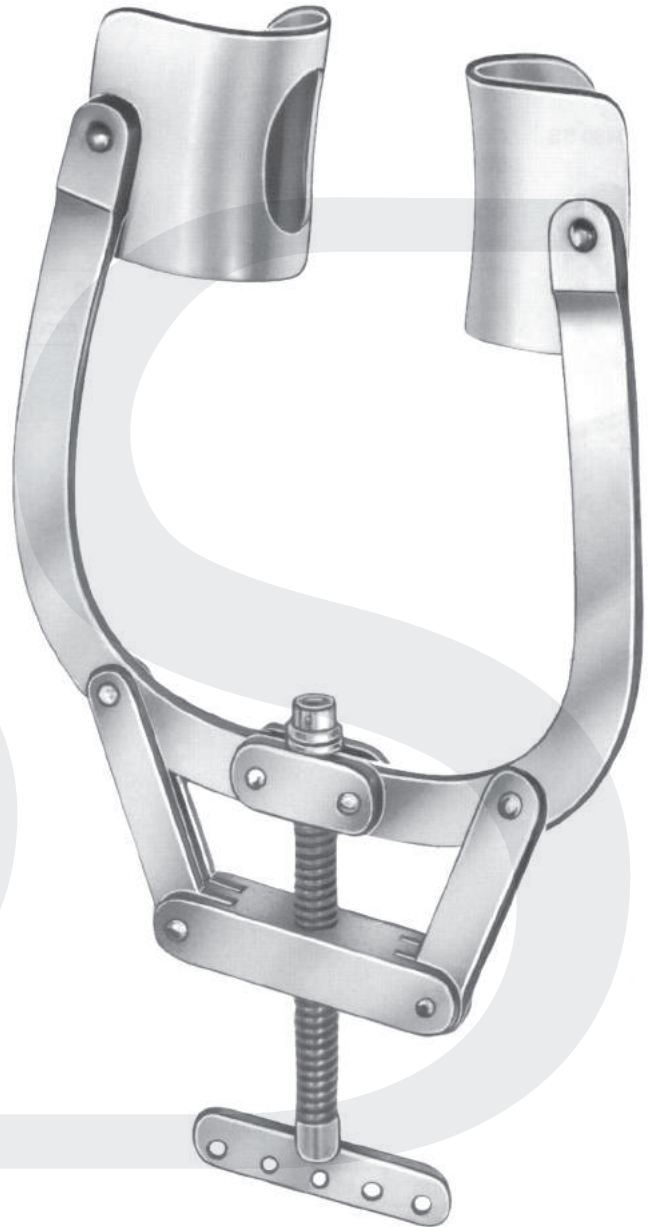

Mercedes

		c	d
21-251-00	mm	285	185

komplett/complete
bestehend aus/consisting of:

21-251-01 Rippensperrer, allein
Rip Retractor, only

21-251-02 Paar/pair

21-251-03 Paar/pair



Sellers
20,0 cm 21-261-19

kurze Klauen
short claws



Baby-Bailey
15,0 cm 21-262-14

lange Klauen
lang claws



Bailey
16,5 cm 21-263-16



Bailey-Gibbon
16,5 cm 21-264-16



Allison

40 mm/25,5 cm **21-301-25**
50 mm/30,0 cm **21-301-30**
54 mm/32,0 cm **21-301-32**



Spatel/Spatula

135 mm/30,0 cm **21-302-30**

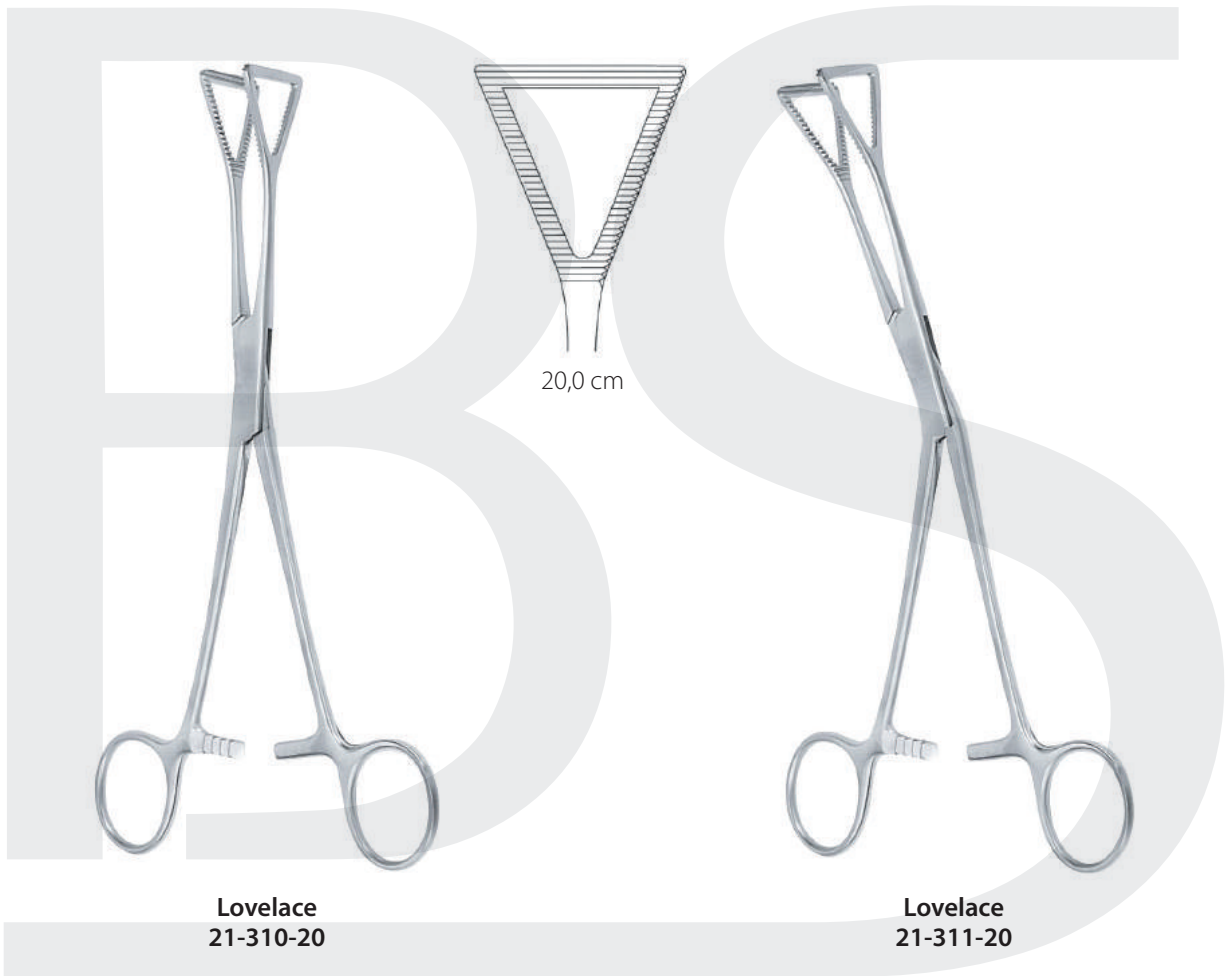



Price-Thomas
22,0 cm 21-313-22



Price-Thomas

Zähne links
teeth left
22,0 cm 21-315-22



Zähne rechts
teeth right
22,0 cm 21-317-22



Semb

25,0 cm 21-325-23

25,0 cm 21-327-23

Vaskular
Vascular

23





Nabatoff
komplett/complete
135x100x25 mm **23-010-00**
Metalletui, allein 23-010-09
Metal case, only

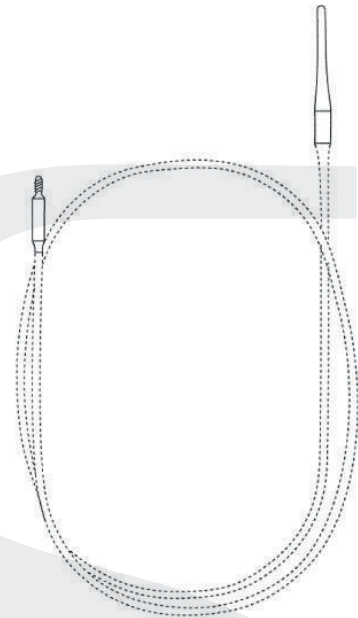

Zugseil
Traction Cable
90 cm **23-010-01**

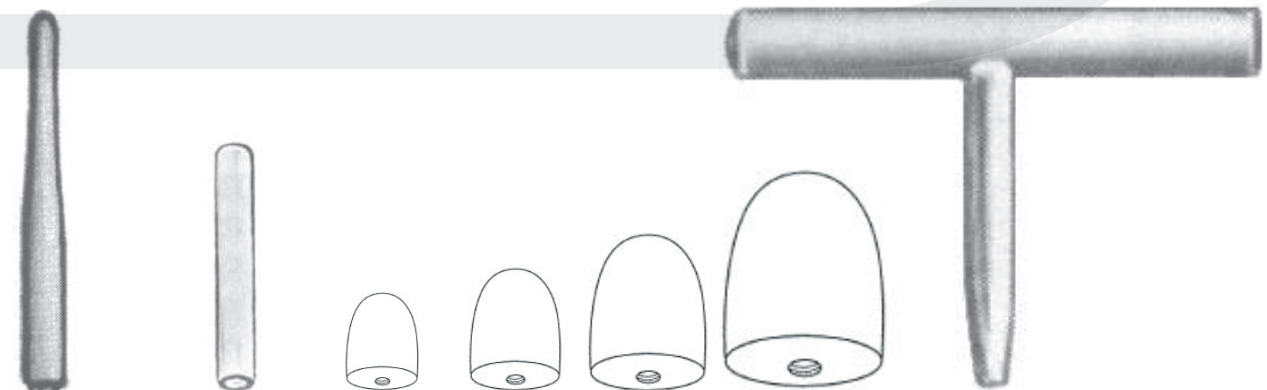

Kunststoffspitze Plastic Probe Tip	Metallspitze Metal Probe Tip	Ø 6,0 mm	Ø 9,0 mm	Ø 12,0 mm	Ø 15,0 mm	Griff/Handle
23-010-02	23-010-03	23-010-04	23-010-05	23-010-06	23-010-07	23-010-08

50,0 cm

50,0 cm

23-011-00, 11,0 cm

Vollmar
23-013-00
Satz/Set Ø 2,0 mm - 14,0 mm

23-013-02 Ø 2,0 mm

23-013-03 Ø 3,0 mm

23-013-04 Ø 4,0 mm

23-013-06 Ø 6,0 mm

23-013-07 Ø 7,0 mm

23-013-08 Ø 8,5 mm

23-013-10 Ø 10 mm

23-013-12 Ø 12 mm

23-013-14 Ø 14 mm

Vollmar
23-014-00
Satz/Set 2,0 mm - 14,0 mm

23-014-02 2,5x2 mm

23-014-03 3,6x3 mm

23-014-04 5,2x4 mm

23-014-05 6,5x5 mm

23-014-06 7,8x6 mm

23-014-07 9x7 mm

23-014-08 10,5x8 mm

23-014-09 11,5x9 mm

23-014-10 13x10 mm

23-014-12 16x12 mm

23-014-14 19x14 mm

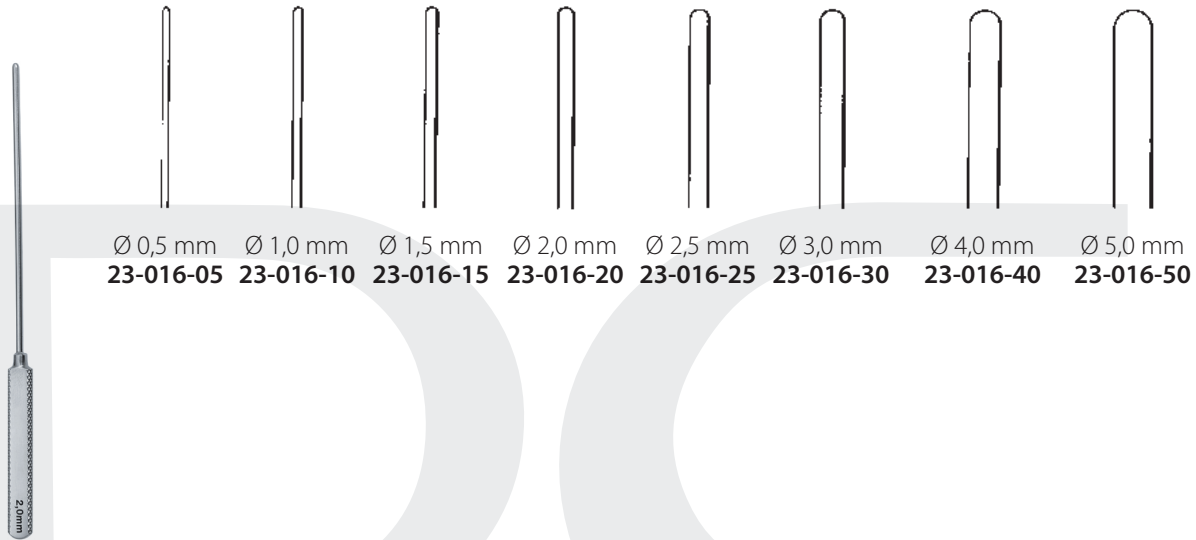

Ø 0,5 mm 23-016-05 Ø 1,0 mm 23-016-10 Ø 1,5 mm 23-016-15 Ø 2,0 mm 23-016-20 Ø 2,5 mm 23-016-25 Ø 3,0 mm 23-016-30 Ø 4,0 mm 23-016-40 Ø 5,0 mm 23-016-50



Cooley, 13,0 cm

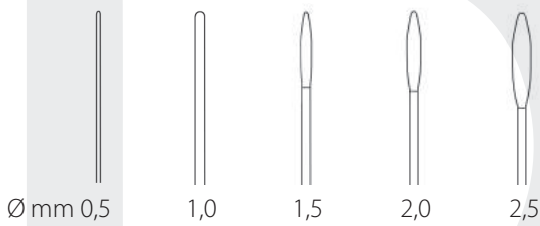

Ø mm 0,5 1,0 1,5 2,0 2,5

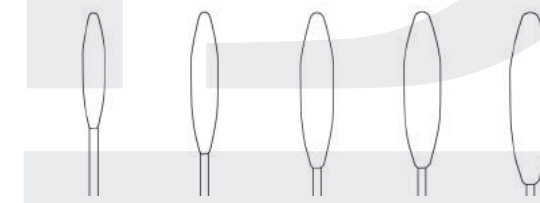

Ø mm 3,0 3,5 4,0 4,5 5,0

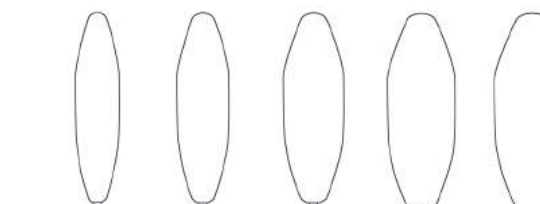

Ø mm 6,0 7,0 8,0 9,0 10,0

19,0 cm	35,0 cm	Ø mm
23-018-05	23-019-05	0,5
23-018-10	23-019-10	1,0
23-018-15	23-019-15	1,5
23-018-20	23-019-20	2,0
23-018-25	23-019-25	2,5
23-018-30	23-019-30	3,0
23-018-35	23-019-35	3,5
23-018-40	23-019-40	4,0
23-018-45	23-019-45	4,5
23-018-50	23-019-50	5,0
23-018-60	23-019-60	6,0
23-018-70	23-019-70	7,0
23-018-80	23-019-80	8,0
23-018-90	23-019-90	9,0
23-018-99	23-019-99	10,0



De Bakey

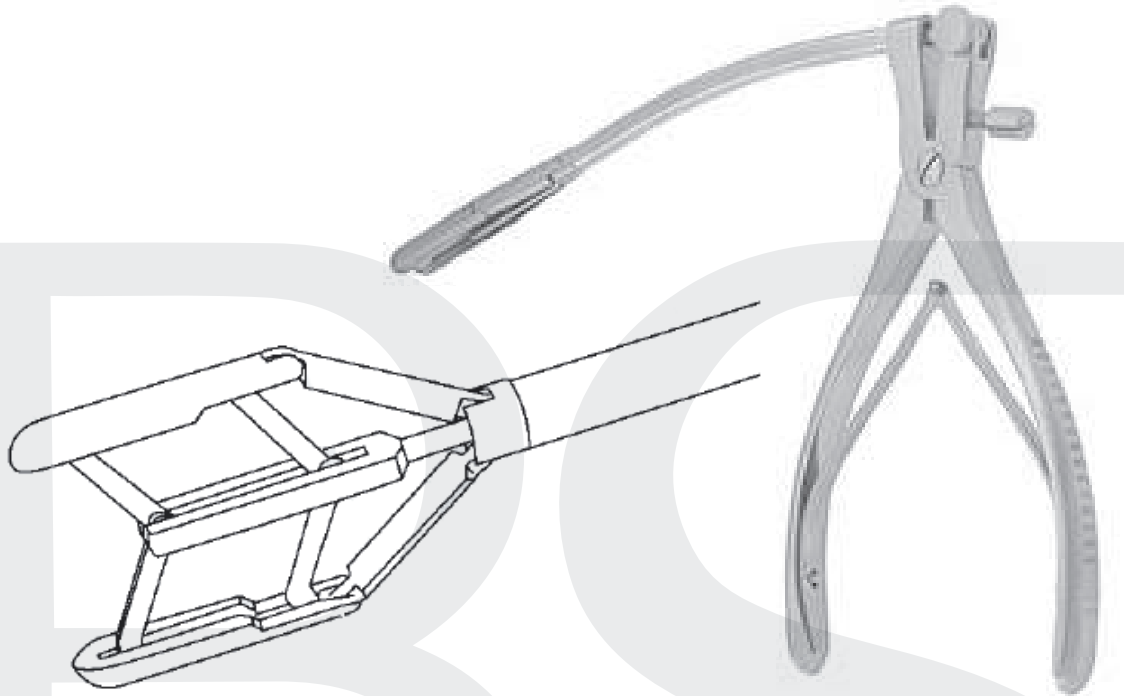

Spreizweite 8 - 42 mm
Blade opening 8 - 42 mm

Tubbs
23-030-00

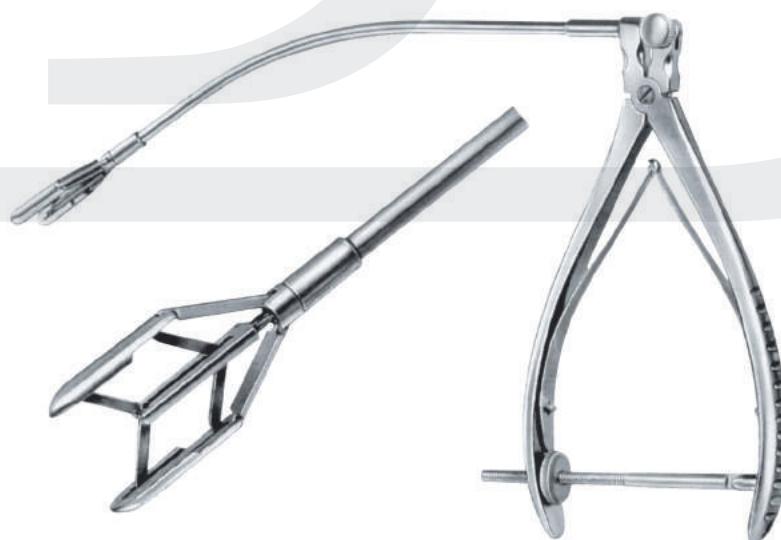

Spreizweite 8 - 15 mm
Blade opening 8 - 15 mm

Cooley
23-032-00

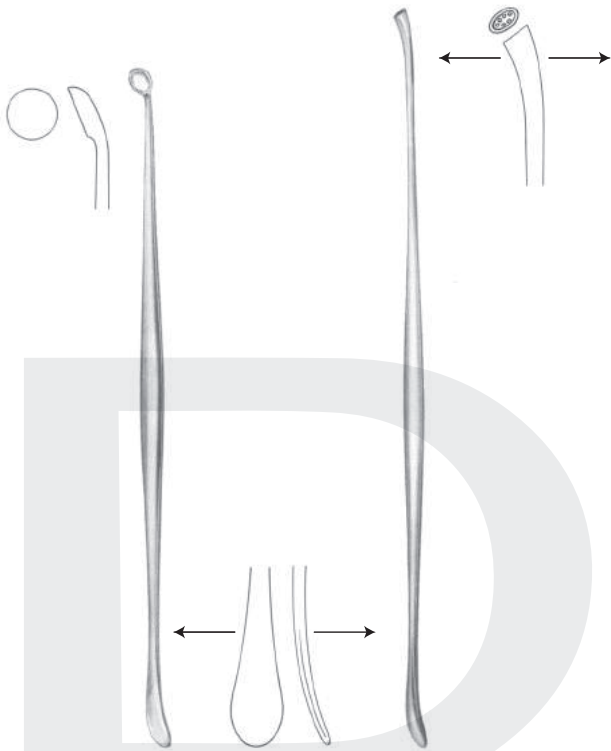

Penfield, Fig. 1
17,5 cm **23-100-01**

Penfield, Fig. 2
19,5 cm **23-100-02**

Penfield, Fig. 3
19,5 cm **23-100-03**



Penfield, Fig. 4
20,5 cm **23-100-04**



Penfield, Fig. 5
29,0 cm **23-100-05**



Halle
18,0 cm **23-102-18**



23,0 cm **23-104-23**



18,5 cm **23-107-18**
21,5 cm **23-107-21**



14,0 cm, 4 mm
23-108-14



23,0 cm, 6 mm
23-108-23

Schmid

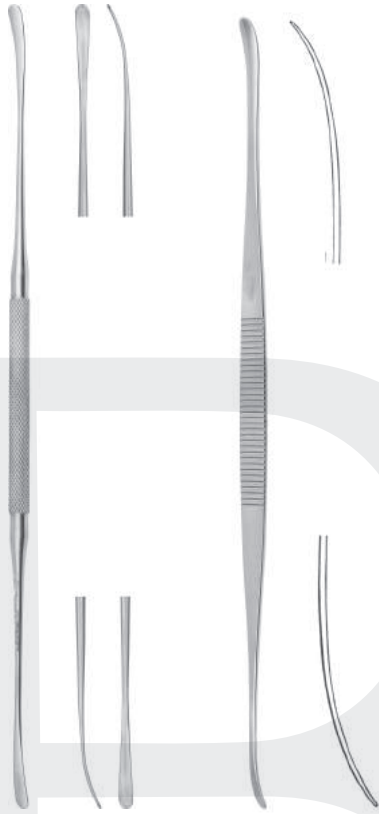

Davis
24,5 cm **23-109-24**

Tönnis
24,0 cm

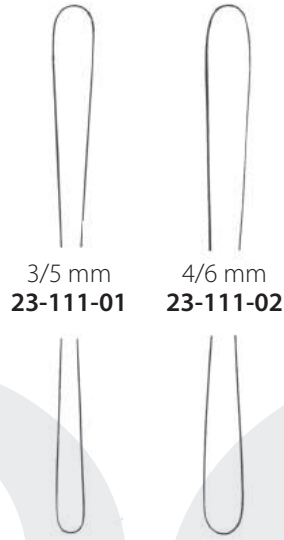

3/5 mm
23-111-01

4/6 mm
23-111-02



Robb
Fig. 1
2,5/5,0 mm
23-113-01

Robb
Fig. 2
2,0/4,0 mm
23-113-02

Robb
Fig. 3
1,5/3,0 mm
23-113-03

Robb
Fig. 4
1,5/2,0 mm
23-113-04



23-115-01

23-115-02

23-115-03



Rumel-Belmont, 32,0 cm

Ø 3,2 mm **23-130-32**

Ø 4,0 mm **23-130-40**

Ø 6,4 mm **23-130-64**



Cooley
rechts/right
45x48 mm
24,5 cm 23-200-24



Cooley
rechts, gezahnt/right, serrated
45x48 mm nach innen gebogen/curved inwards
24,5 cm 23-201-24



Cooley
links/left
25x46 nach außen gebogen/curved outwards
25,5 cm 23-202-25



Cooley
rechts, gezahnt/right, serrated
24,0 cm 45x30 mm 23-203-24
24,0 cm 45x35 mm 23-204-24

Klingenbecher und Klingenthaler Scalpel Breaker and Holder

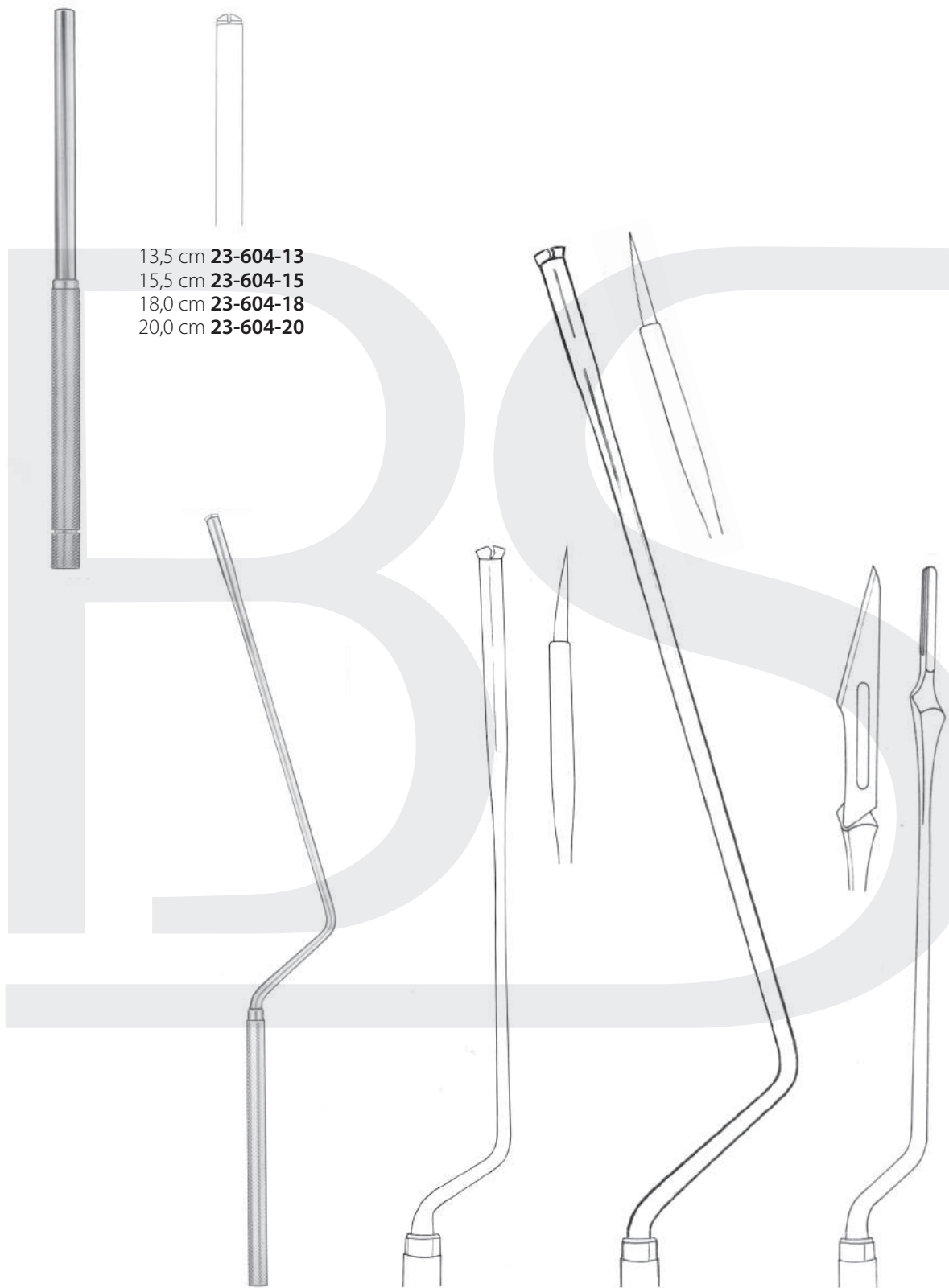

13,5 cm **23-604-13**
15,5 cm **23-604-15**
18,0 cm **23-604-18**
20,0 cm **23-604-20**

21,0 cm **23-611-21**

Landolt
25,0 cm **23-613-25**

21,0 cm **23-615-21**

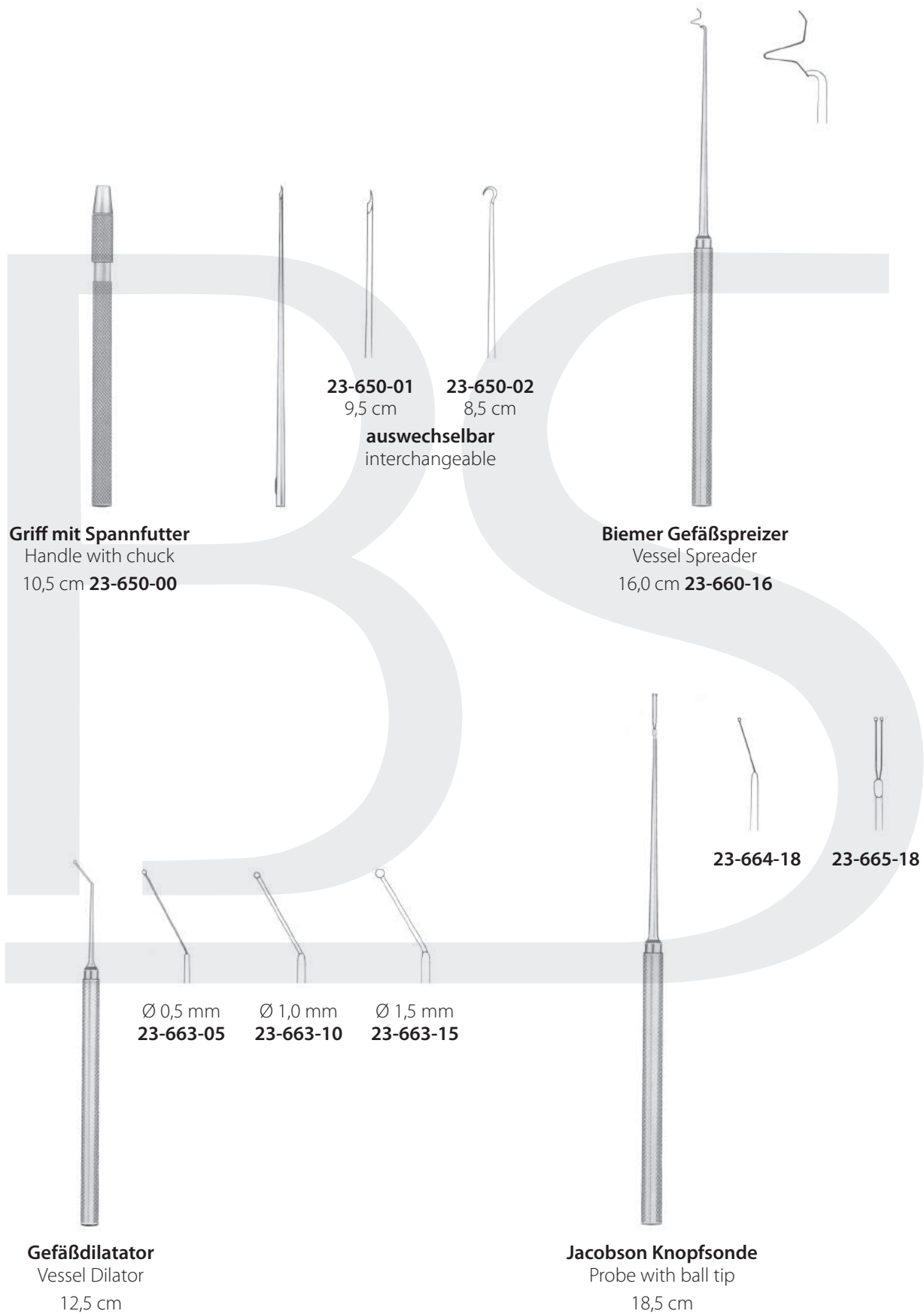



Jacobson
Fadengabel/Suture Pusher
18,5 cm 23-666-18

Caspar
Fadengabel/Suture Pusher
23,0 cm 23-667-23

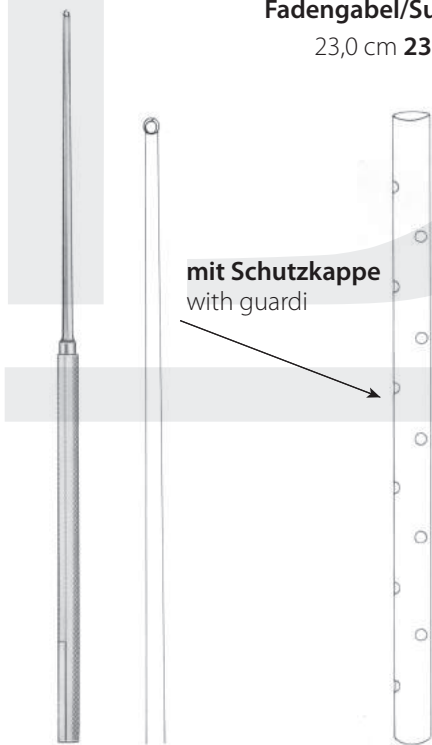

Gewebekralle
Tissue Picks
Ø 1,8 mm
18,5 cm 23-674-18

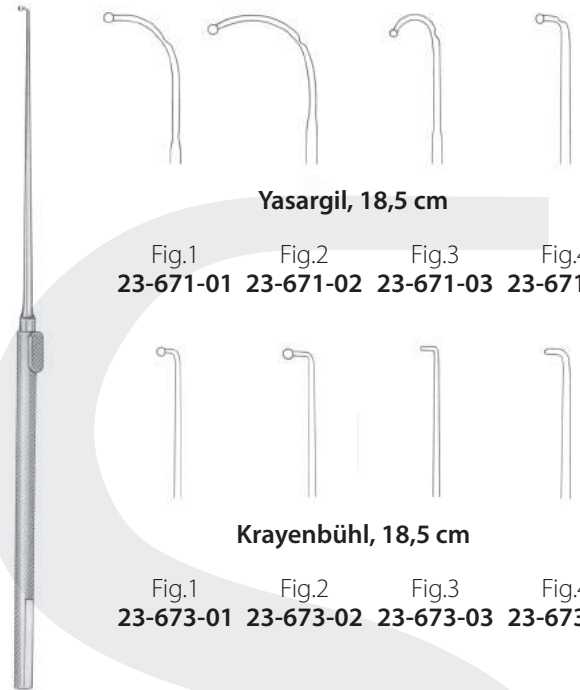

Yasargil, 18,5 cm
Fig.1 23-671-01 Fig.2 23-671-02 Fig.3 23-671-03 Fig.4 23-671-04

Krayenbühl, 18,5 cm
Fig.1 23-673-01 Fig.2 23-673-02 Fig.3 23-673-03 Fig.4 23-673-04

90° gebogen curved 18,5 cm 23-675-01
90° abgewinkelt angled 23-675-02

Scharfes Häkchen
Sharp Hook

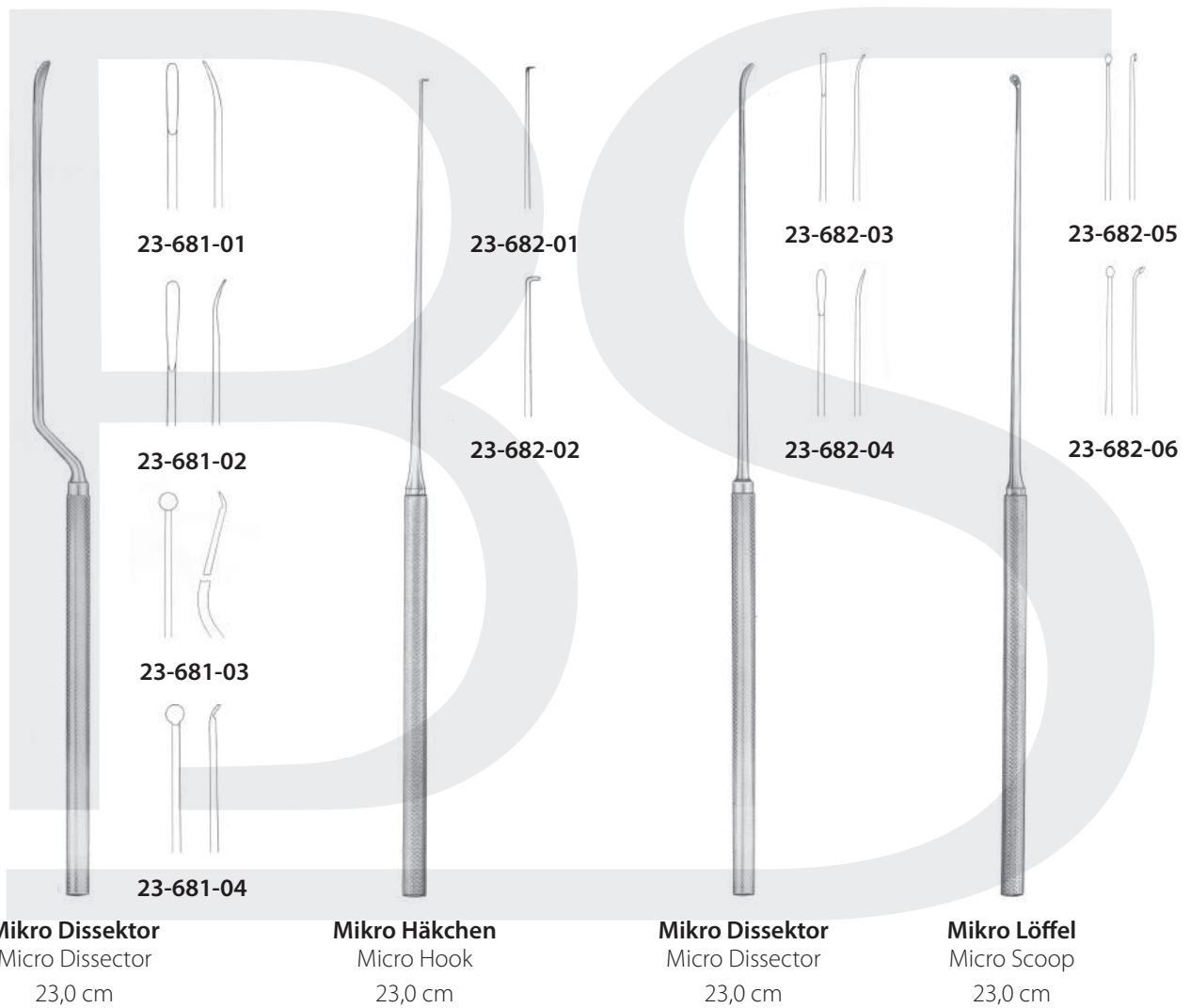

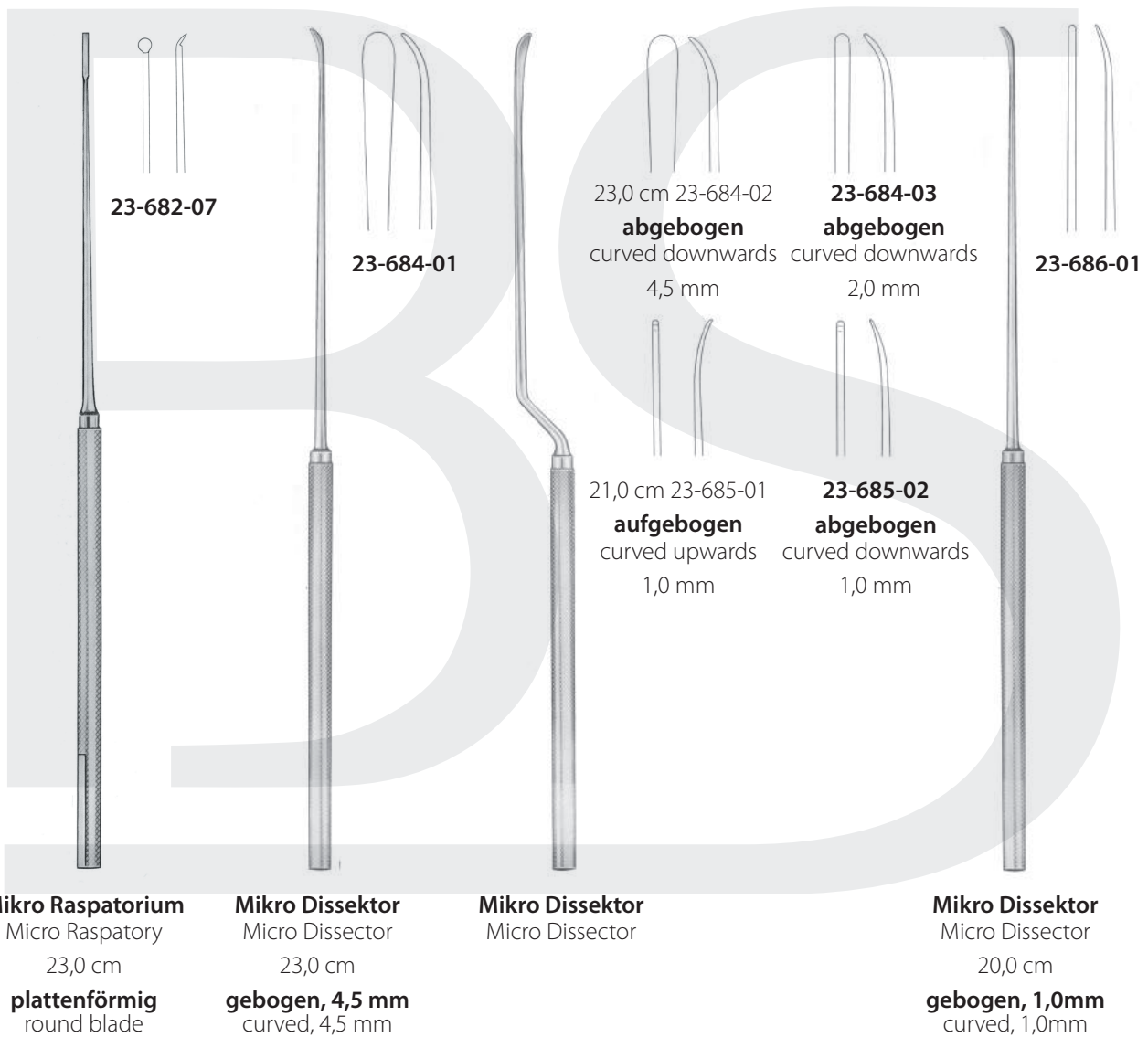
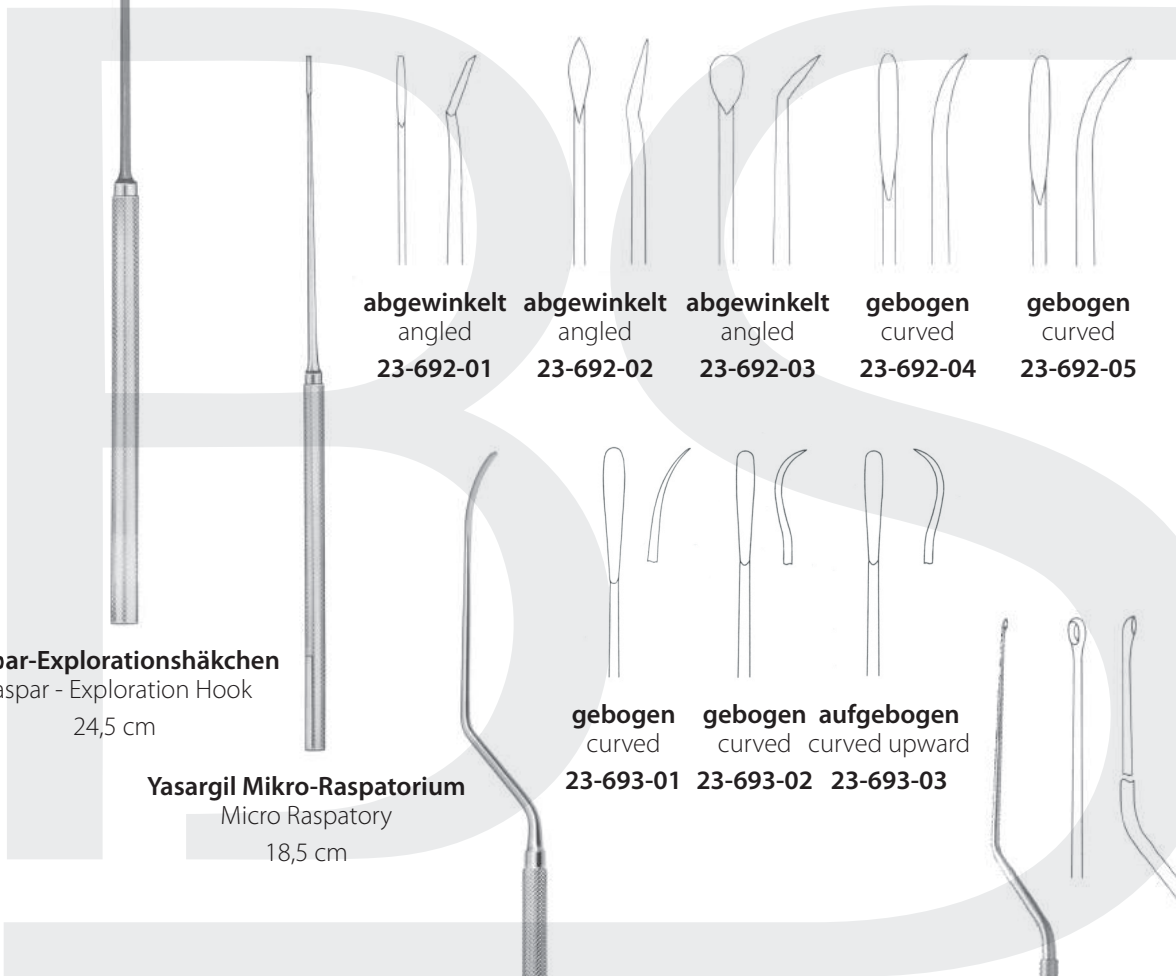



Fig. 1 **23-688-01** Fig. 2 **23-688-02** Fig. 3 **23-688-03** Fig. 4 **23-688-04**

geknöpft, isoliert
probe-end, insulated



abgewinkelt **abgewinkelt** **abgewinkelt** **gebogen** **gebogen**
angled angled angled curved curved
23-692-01 **23-692-02** **23-692-03** **23-692-04** **23-692-05**

gebogen **gebogen** **gebogen**
curved curved curved upward
23-693-01 **23-693-02** **23-693-03**





Caspar-Explorationshäkchen
Caspar - Exploration Hook
24,5 cm



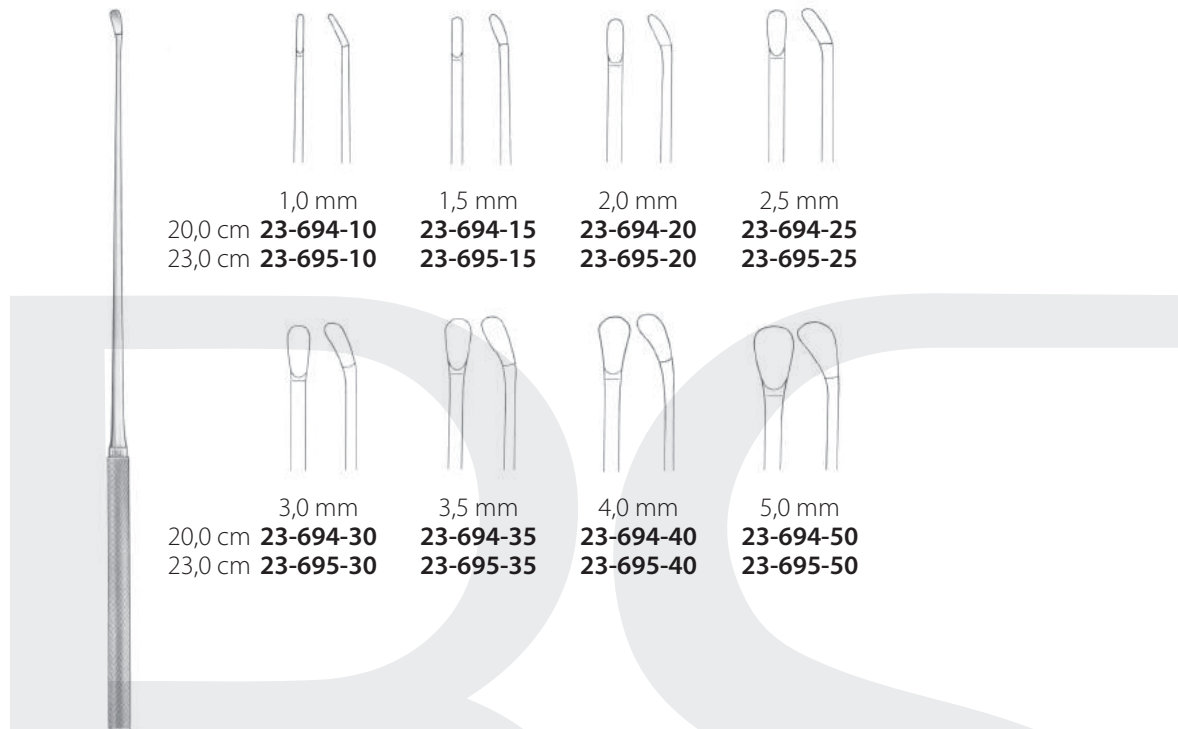

Yasargil Mikro-Raspatorium
Micro Raspatory
18,5 cm

Yasargil Mikro-Raspatorium
Micro Raspatory
18,5 cm



Yasargil scharfer Mikro-Löffel
Micro Scoop
18,5 cm **23-693-04**





				
	1,0 mm	1,5 mm	2,0 mm	2,5 mm
20,0 cm	23-694-10	23-694-15	23-694-20	23-694-25
23,0 cm	23-695-10	23-695-15	23-695-20	23-695-25

				
	3,0 mm	3,5 mm	4,0 mm	5,0 mm
20,0 cm	23-694-30	23-694-35	23-694-40	23-694-50
23,0 cm	23-695-30	23-695-35	23-695-40	23-695-50

Samii Tumormesser
Tumor Knife

				
	1,5 mm	3,0 mm	4,5 mm	6,0 mm
20,0 cm	23-696-15	23-696-30	23-696-45	23-696-60
23,0 cm	23-697-15	23-697-30	23-697-45	23-697-60

		
	1,8 mm	2,5 mm
23,0 cm	23-698-18	23-698-25

Samii Tumormesser
Tumor Knife

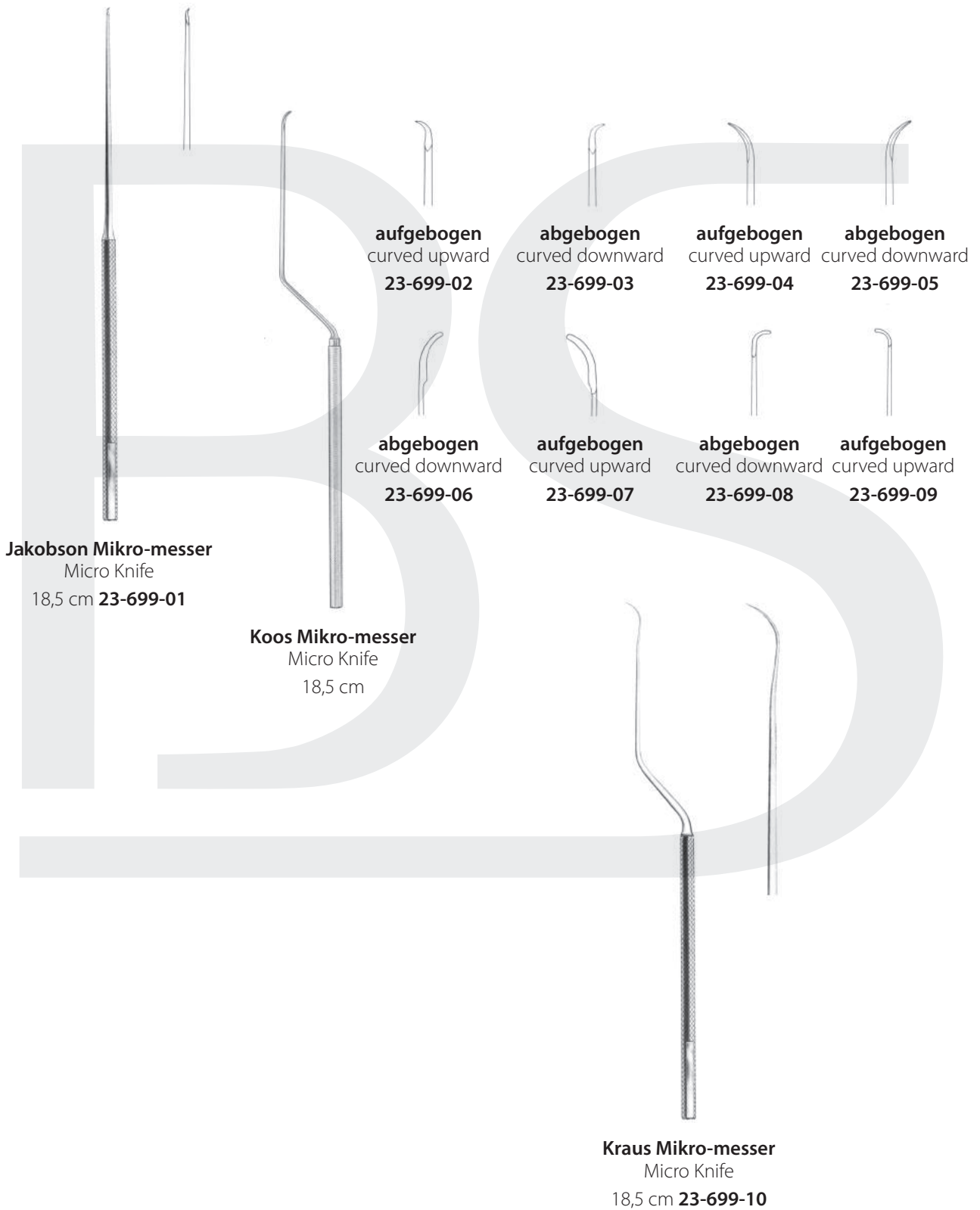

Magen-Darm-Rektum
Stomach Intestinal Rectum

25

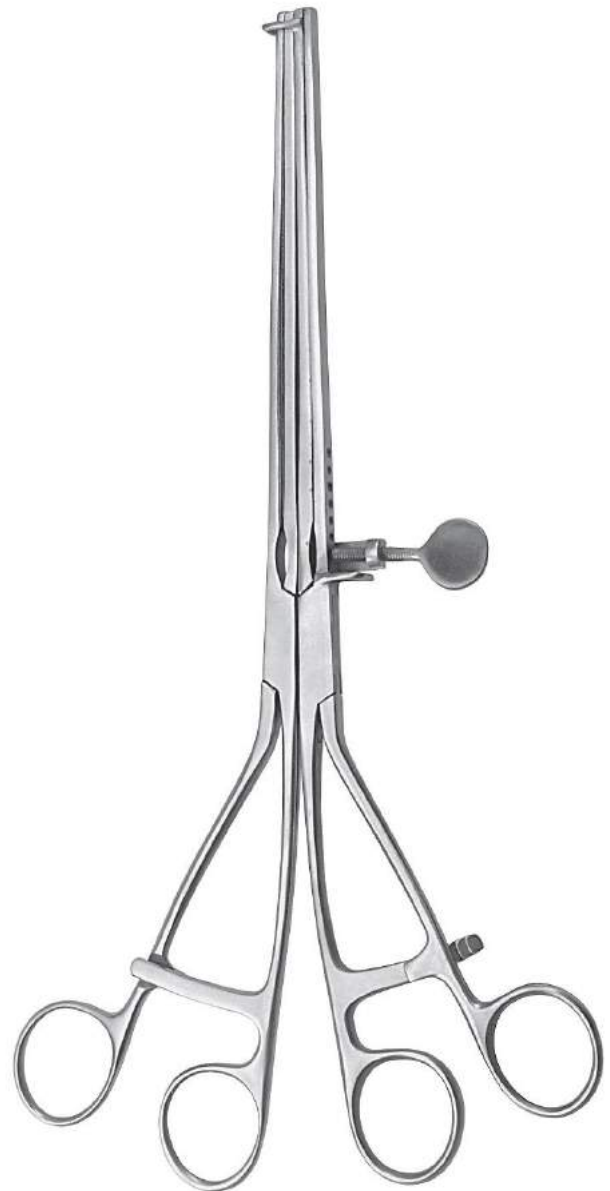

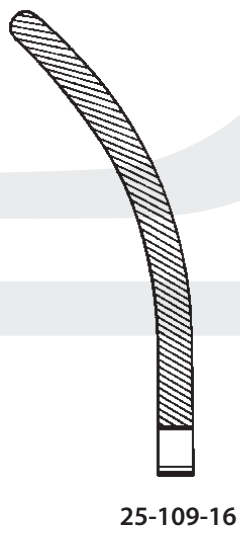
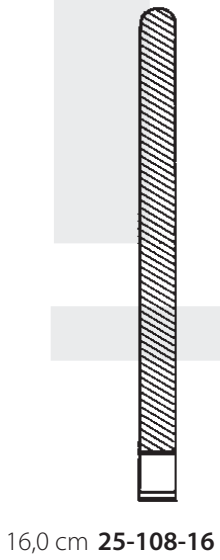
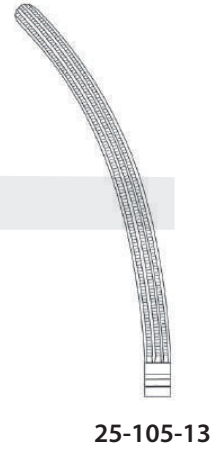
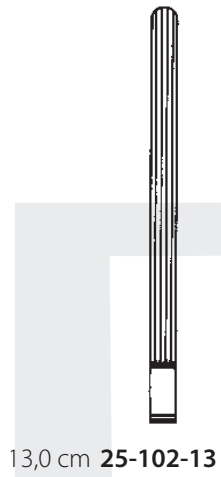

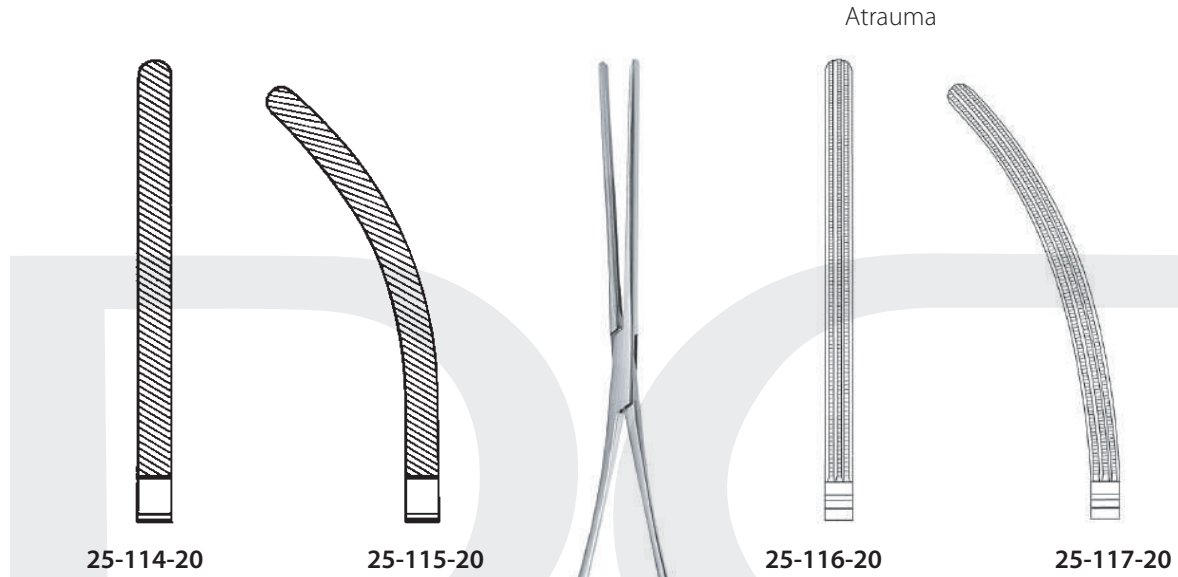

Atrauma

25-114-20

25-115-20

25-116-20

25-117-20



Hartmann, 20 cm

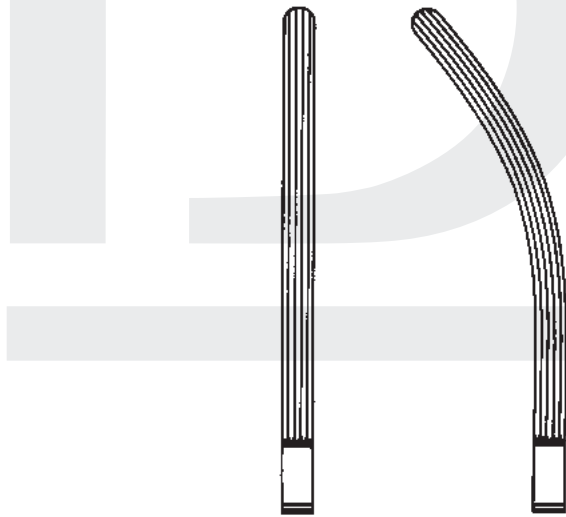

21,0 cm 25-120-21
23,0 cm 25-120-23

25-121-21
25-121-23



Kocher

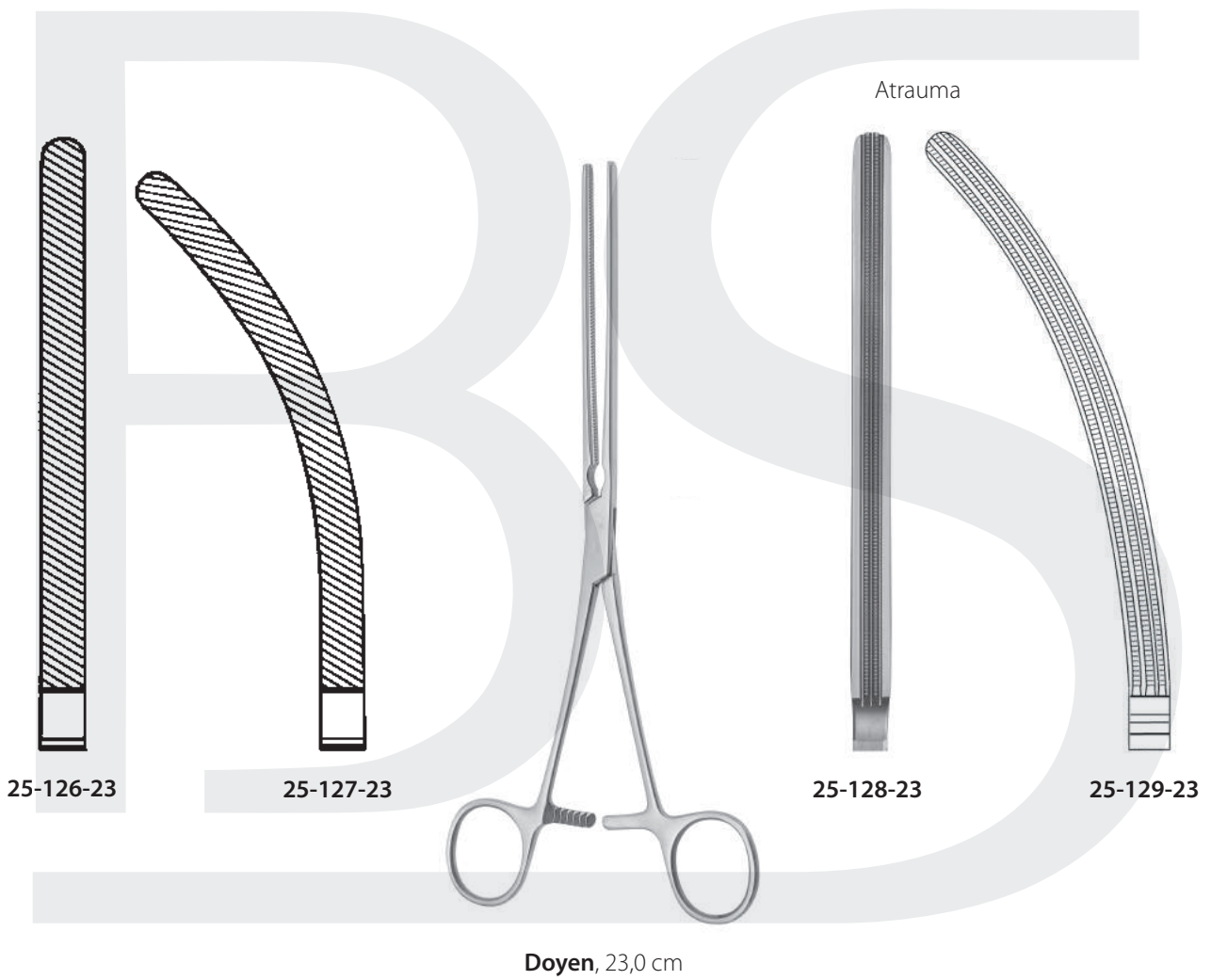

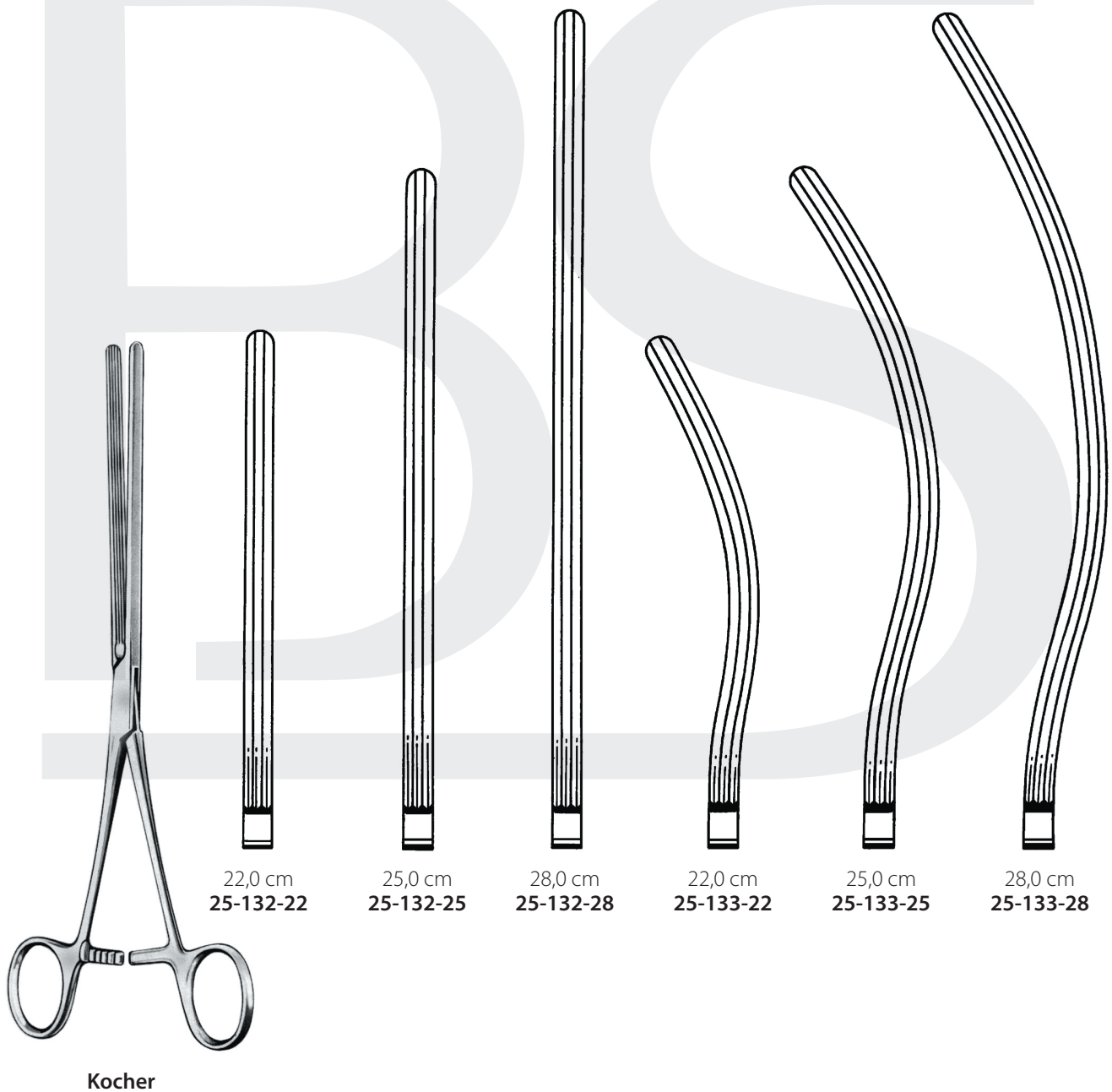

Atrauma

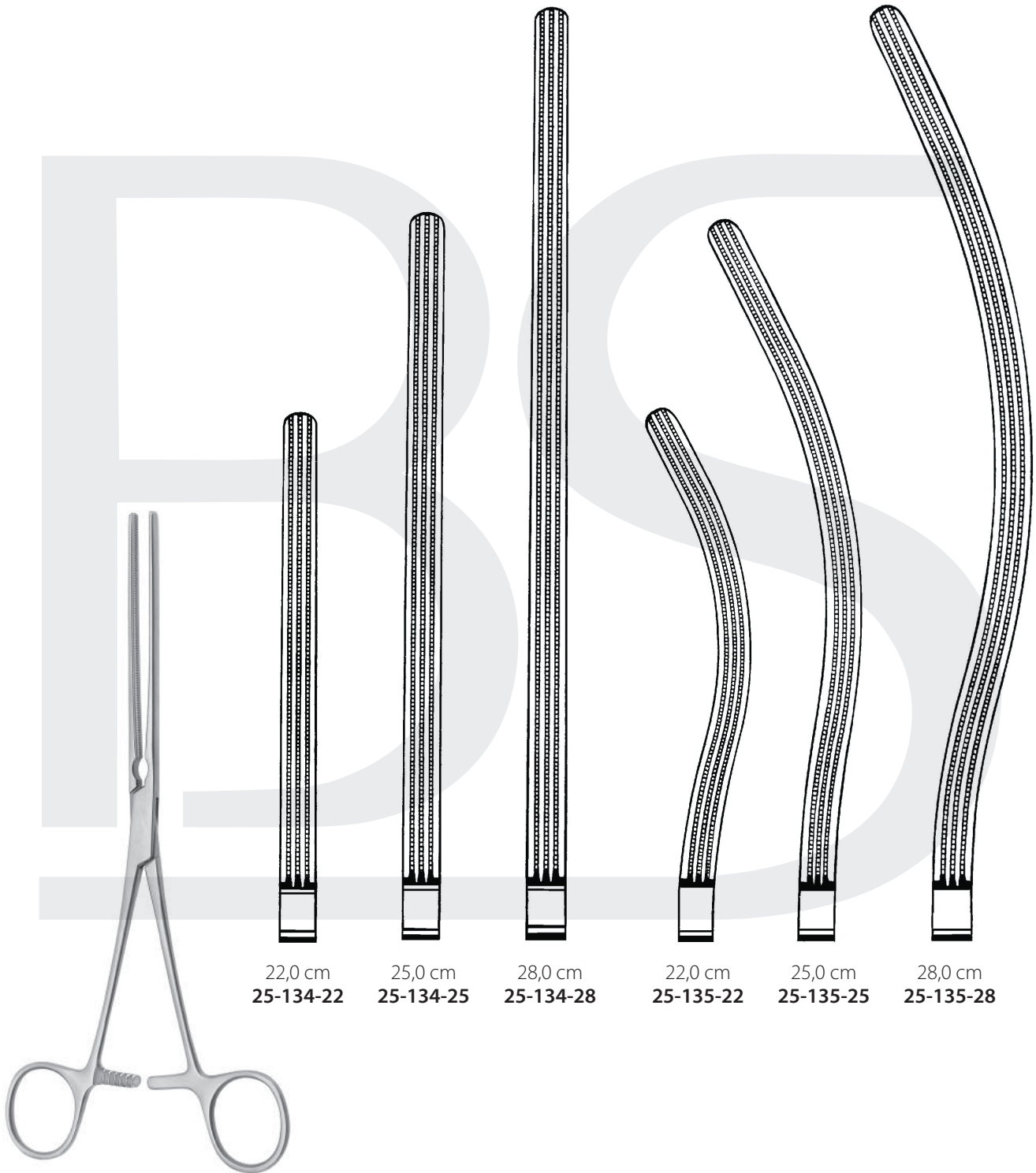

Kocher



Nussbaum, 25,0 cm

25-140-25



25-141-25



Mayo-Robson, 25,0 cm



25-144-25



25-145-25

Atrauma

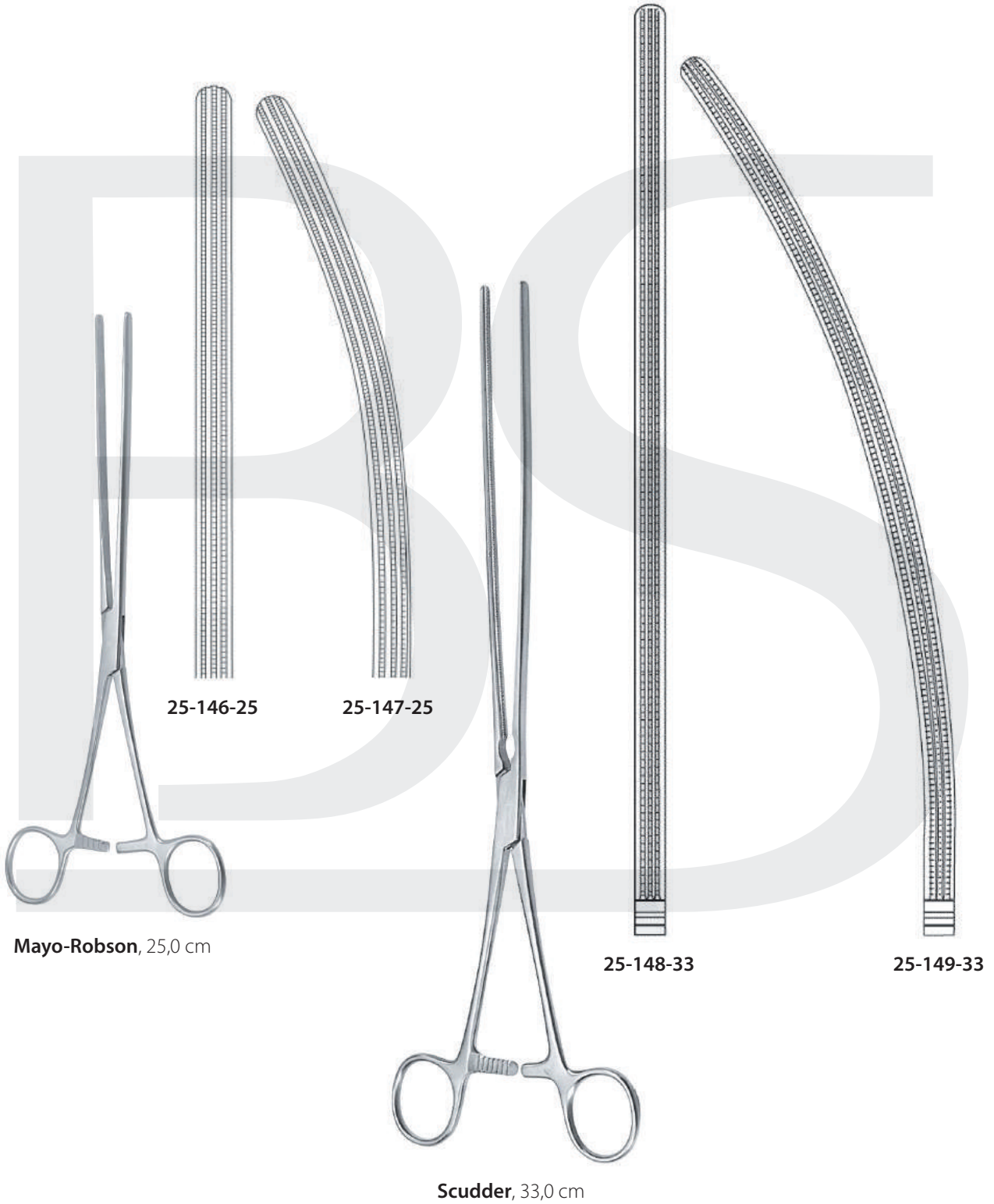

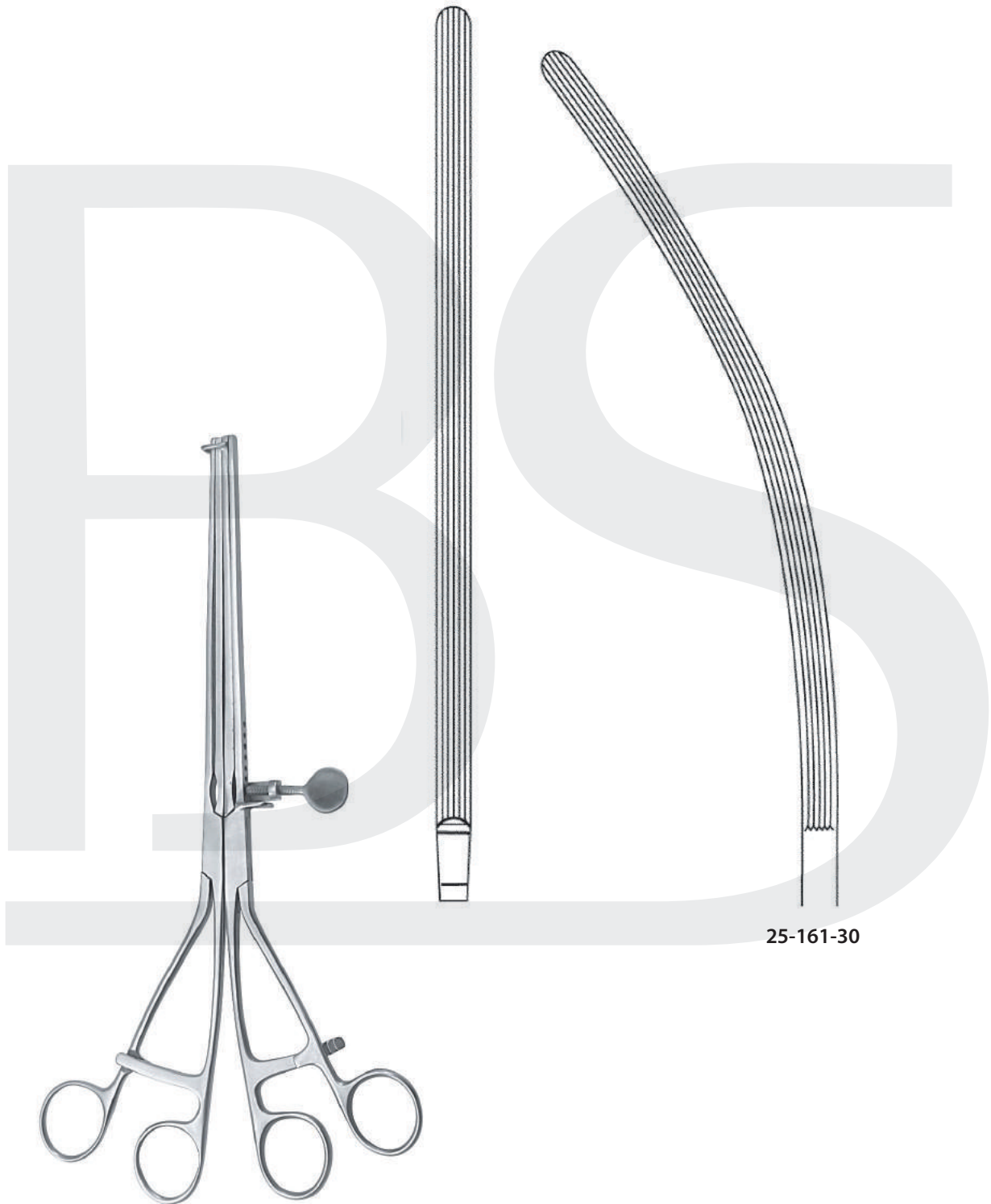

Lane, 30,0 cm
25-160-30

25-161-30



Payr
für Kinder
for Children
18,0 cm **25-167-18**



Payr

20,0 cm
25-167-20

27,0 cm
25-167-27

31,0 cm
25-167-31

Anastomosenklemmen
Anastomosis Clamps

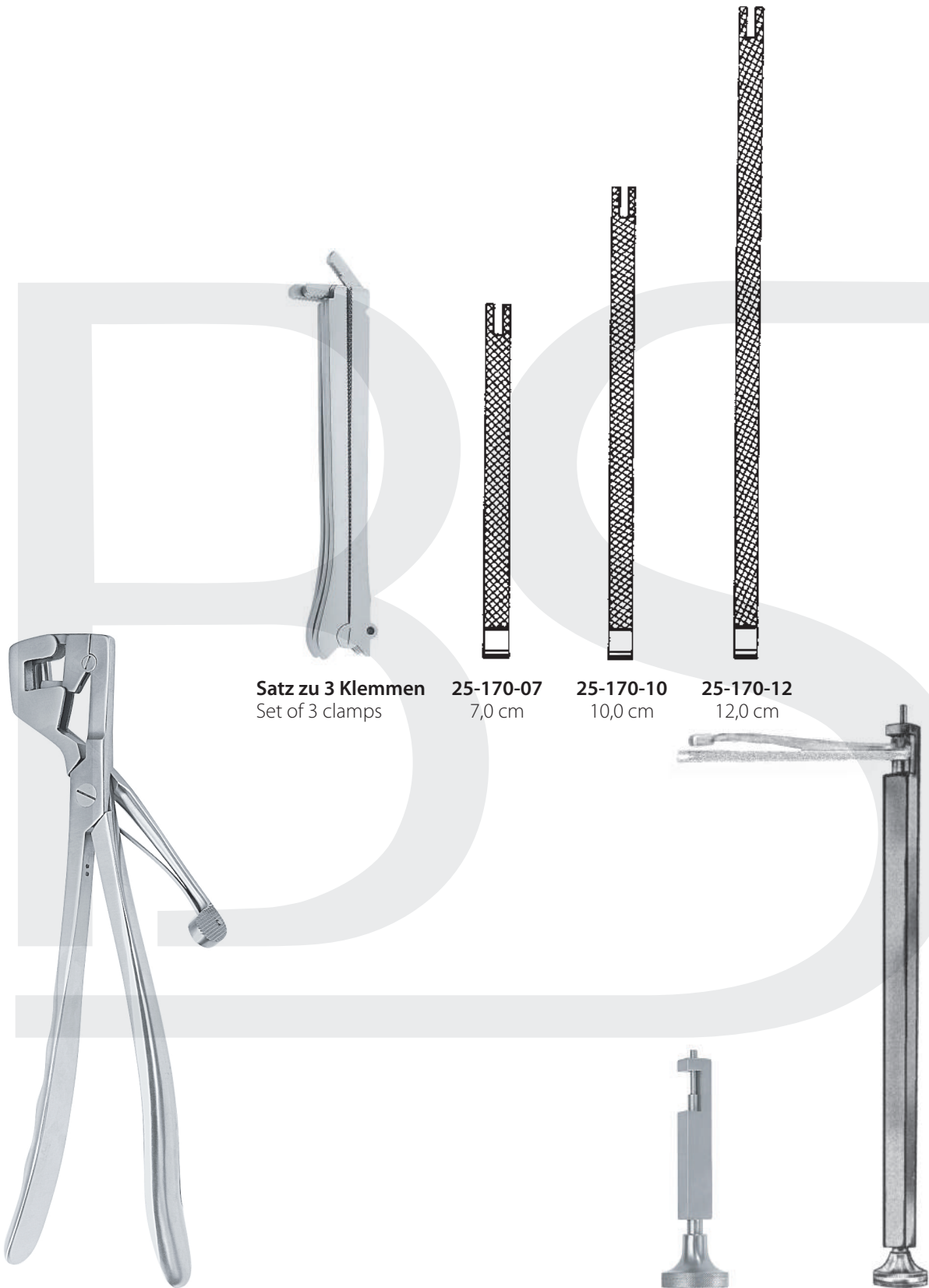

Satz zu 3 Klemmen
Set of 3 clamps

25-170-07
7,0 cm

25-170-10
10,0 cm

25-170-12
12,0 cm

De Martel-Wolfson
26,0 cm **25-171-26**

Klemmhalter
Clamp Holder
8,0 cm **25-176-08**

Klemmhalter
Clamp Holder
23,0 cm **25-176-23**

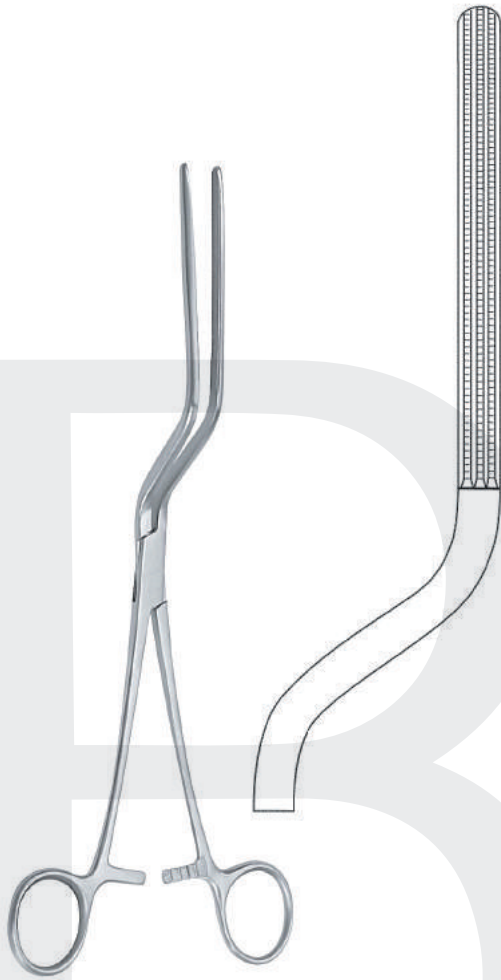

Brunner
24,0 cm 25-185-24



Resano
26,0 cm 25-194-26

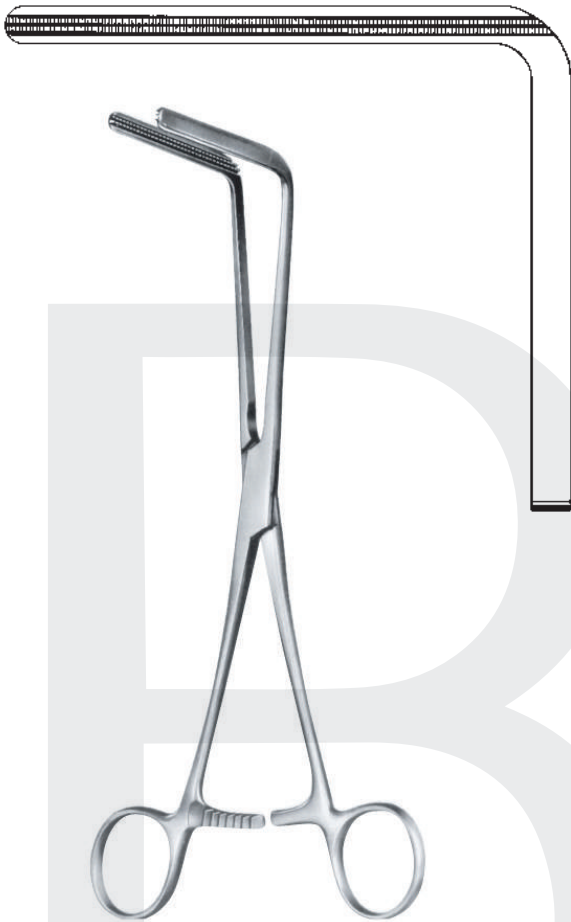

Fehland
24,0 cm **25-196-24**

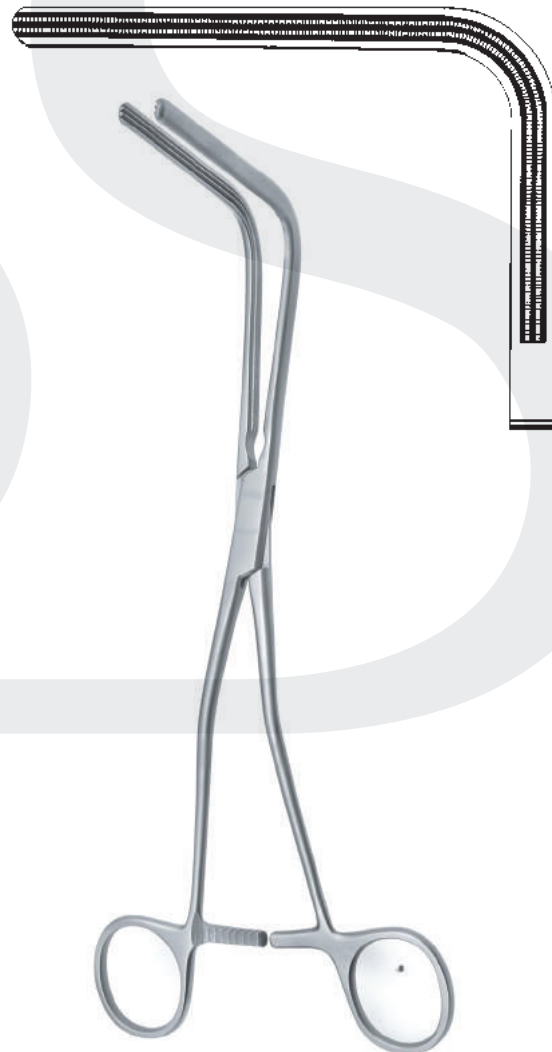

Veidenheimer
23,0 cm **25-197-23**

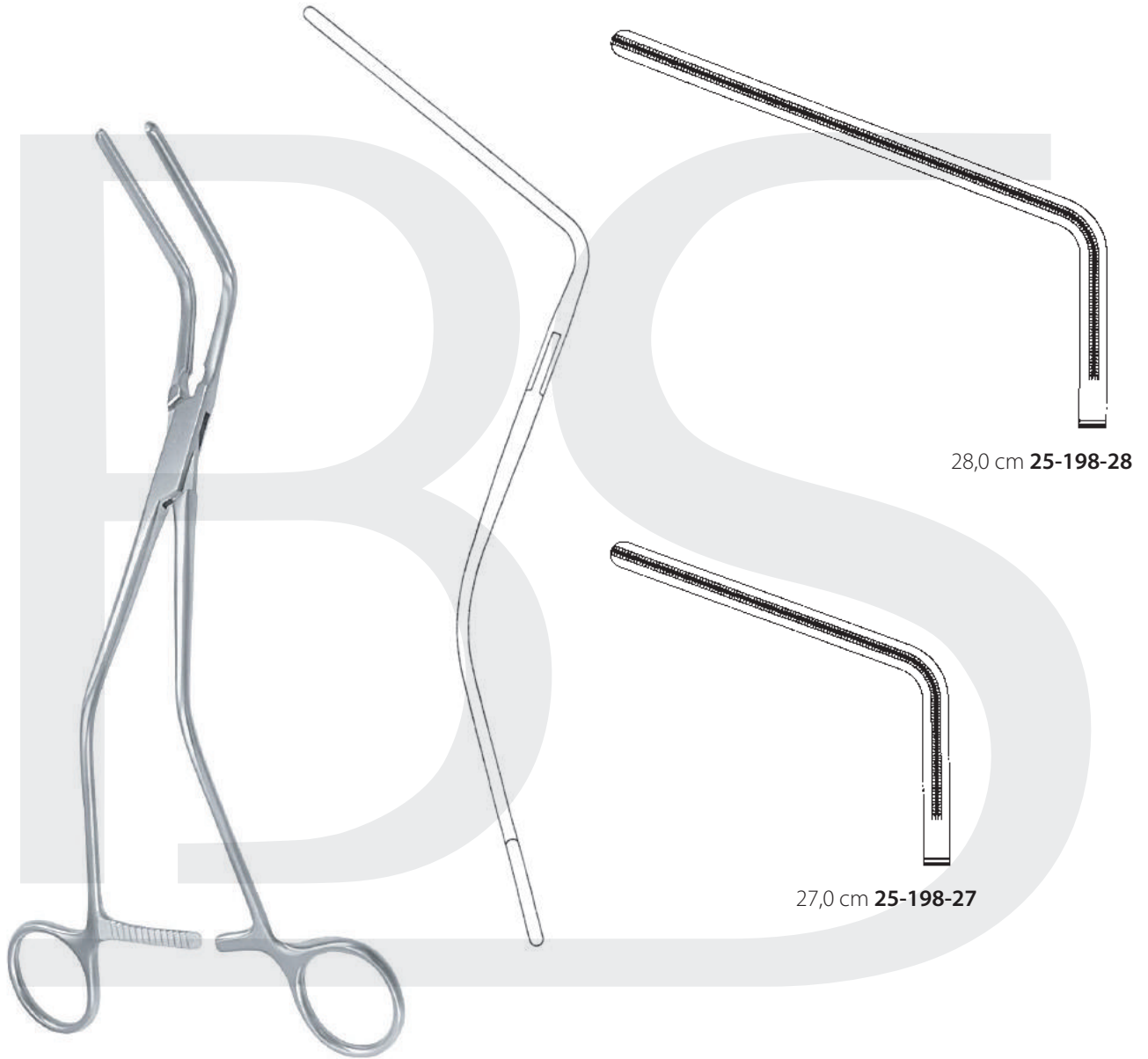

Hayes

28,0 cm 25-198-28

27,0 cm 25-198-27

Mastdarm-Rektum-Spekula
Rectal Specula



Sims
16,0 cm **25-300-16**

Sims
16,0 cm **25-302-16**

Czerny
22,5 cm **25-305-22**

Pratt
20,5 cm **25-308-20**



Sims

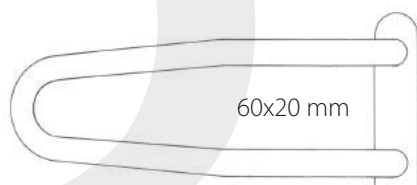

60x20 mm

19,0 cm **25-310-19**



85x20 mm

23,5 cm **25-310-23**

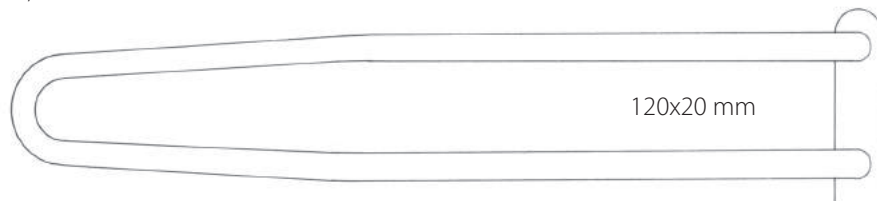

120x20 mm

23,5 cm **25-310-24**

95 x 15 mm



Mathieu
21,5 cm **25-312-21**

90 x 24 mm



Ives-Fansler
8,0 cm, Ø 22 mm **25-316-24**



Kelly
16,0 cm, Ø 21 mm, 50 mm **25-318-21**
16,0 cm, Ø 27 mm, 55 mm **25-318-27**
14,0 cm, Ø 22 mm, 140 mm **25-320-22**

25-330-04 Sphinkter-Blätter 95x22 mm Paar
Sphincter blades 95x22 mm pair



Parks

25-330-03 Rektum-Blätter 70x22 mm Paar
Rectal blades 70x22 mm pair

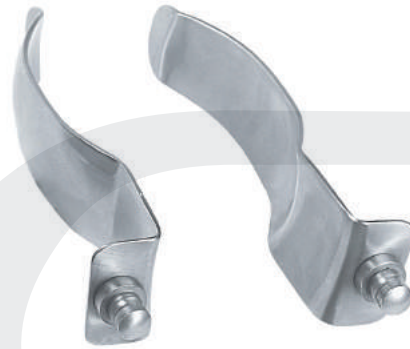

25-330-00 Parks, komplett/complete

bestehend aus/consisting of:

25-330-01 Sperrer, allein/retractor only

25-330-02 Mittelblatt 95 mm/central blade 95 mm

25-330-03 Rektum-Blätter 70x22 mm Paar/Rectal blades 70x22 mm pair

25-330-04 Sphinkter-Blätter 95x22 mm Paar/Sphincter blades 95x22 mm pair

25-331-00 Parks, komplett mit Kaltlicht/complete with fiber optic light carrier

Gummiringe, Pack = 100 St.
Rubber Rings, Pack = 100 pieces
latex-frei / latex-free

25-350-99



Rudd
31,5 cm, Ø 12 mm **25-350-31**

McGinvey
19,0 cm **25-352-18**

Rektum Biopsiezangen
Rectal Biopsy Forceps

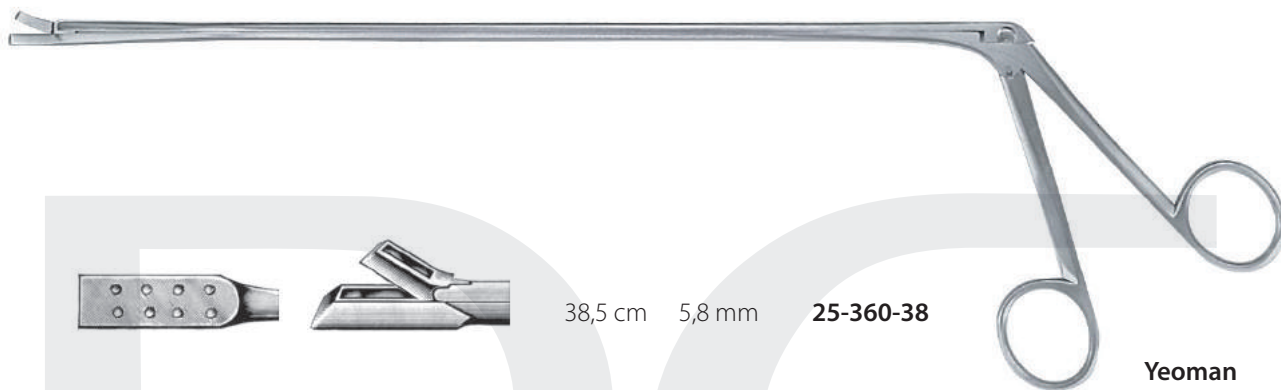

Yeoman



38,5 cm 5,8 mm **25-360-38**



35,0 cm 4,0 mm **25-362-35**
42,0 cm 4,0 mm **25-362-42**

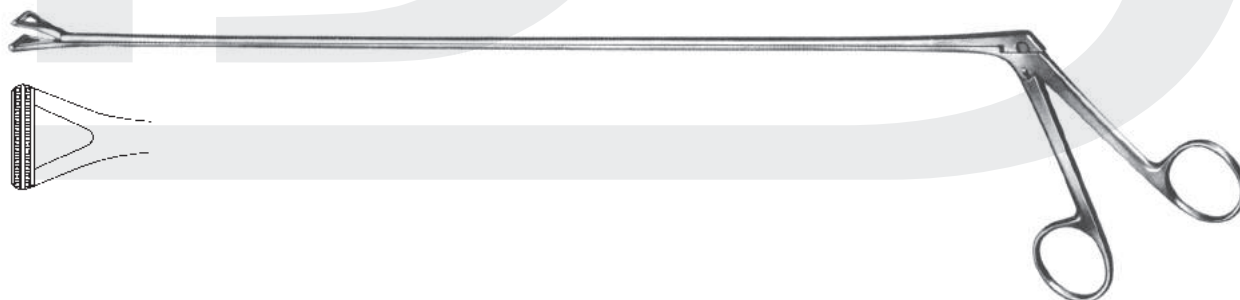

25-370-38
38,0 cm 15 mm

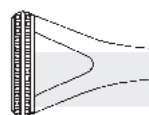

Leber-Galle-Niere
Liver, Gall Bladder, Kidney

26



Schaft biegsam
Shaft malleable

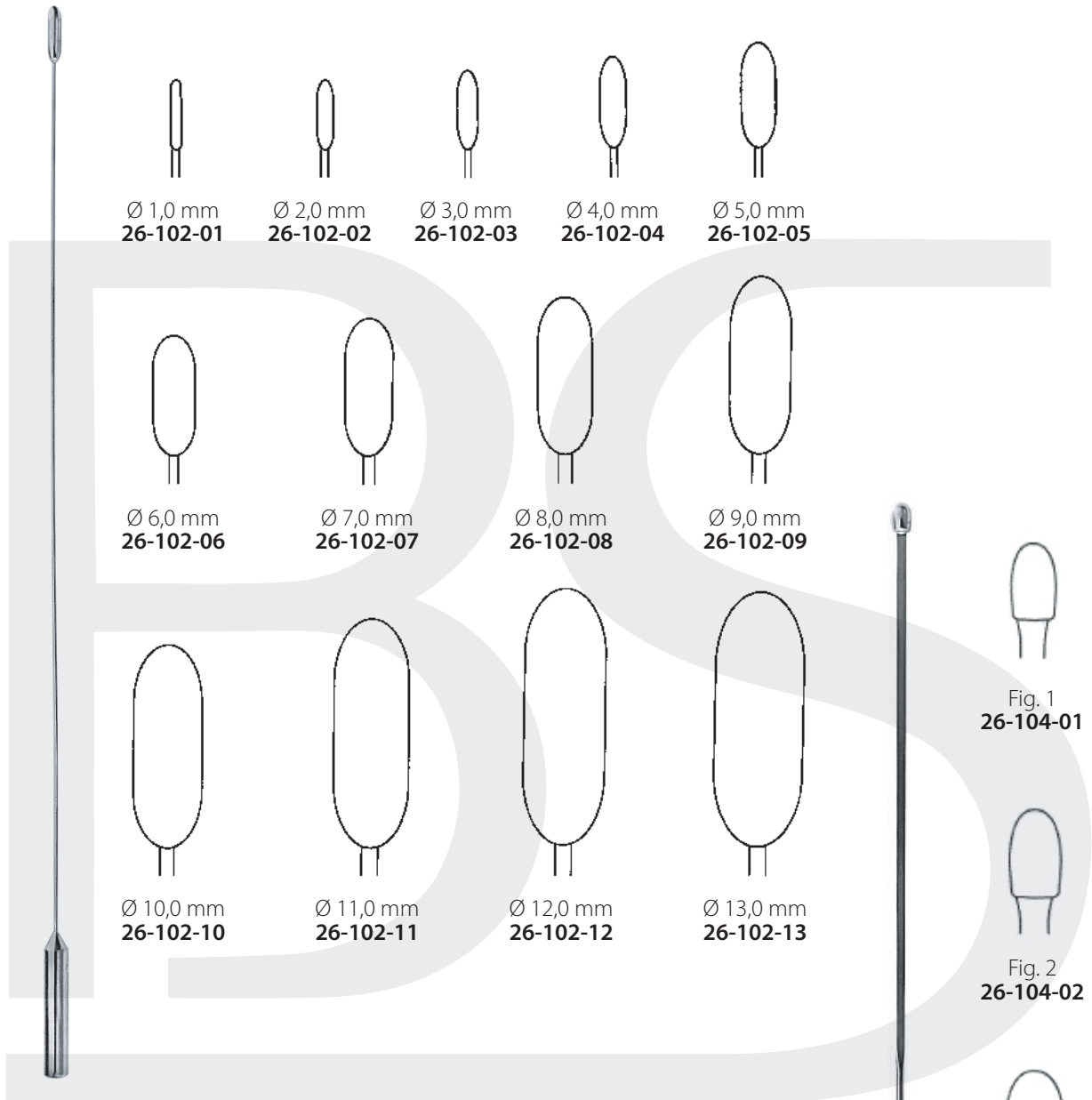

Ø 1,0 mm
26-102-01

Ø 2,0 mm
26-102-02

Ø 3,0 mm
26-102-03

Ø 4,0 mm
26-102-04

Ø 5,0 mm
26-102-05

Ø 6,0 mm
26-102-06

Ø 7,0 mm
26-102-07

Ø 8,0 mm
26-102-08

Ø 9,0 mm
26-102-09

Ø 10,0 mm
26-102-10

Ø 11,0 mm
26-102-11

Ø 12,0 mm
26-102-12

Ø 13,0 mm
26-102-13

Fig. 1
26-104-01

Fig. 2
26-104-02

Bakes, 31,0 cm

Schaft federnd
Shaft flexible

Fig. 3
26-104-03

Dejardins, 30,0 cm

Gallensteinlöffel
Gall Stone Scoops

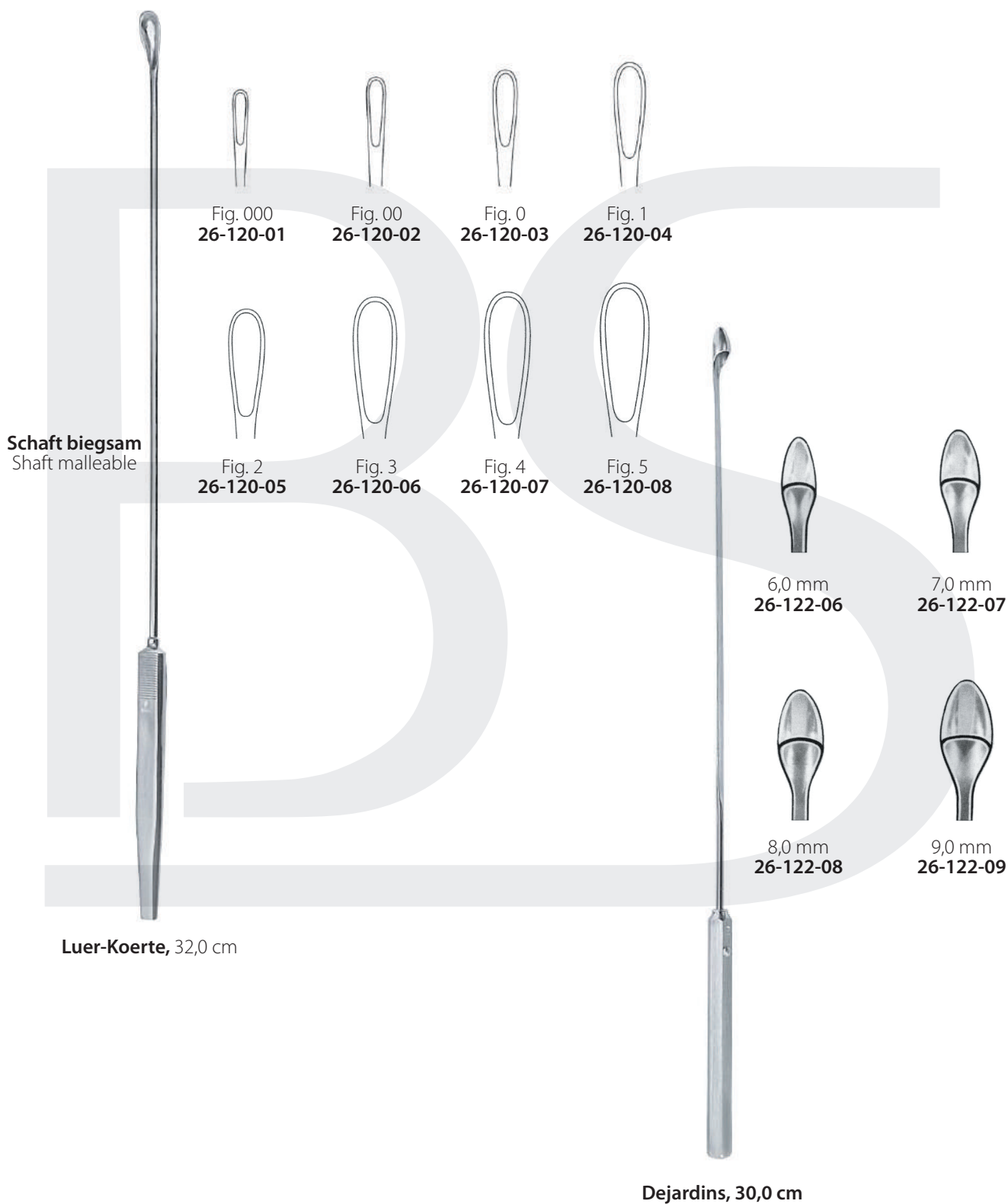

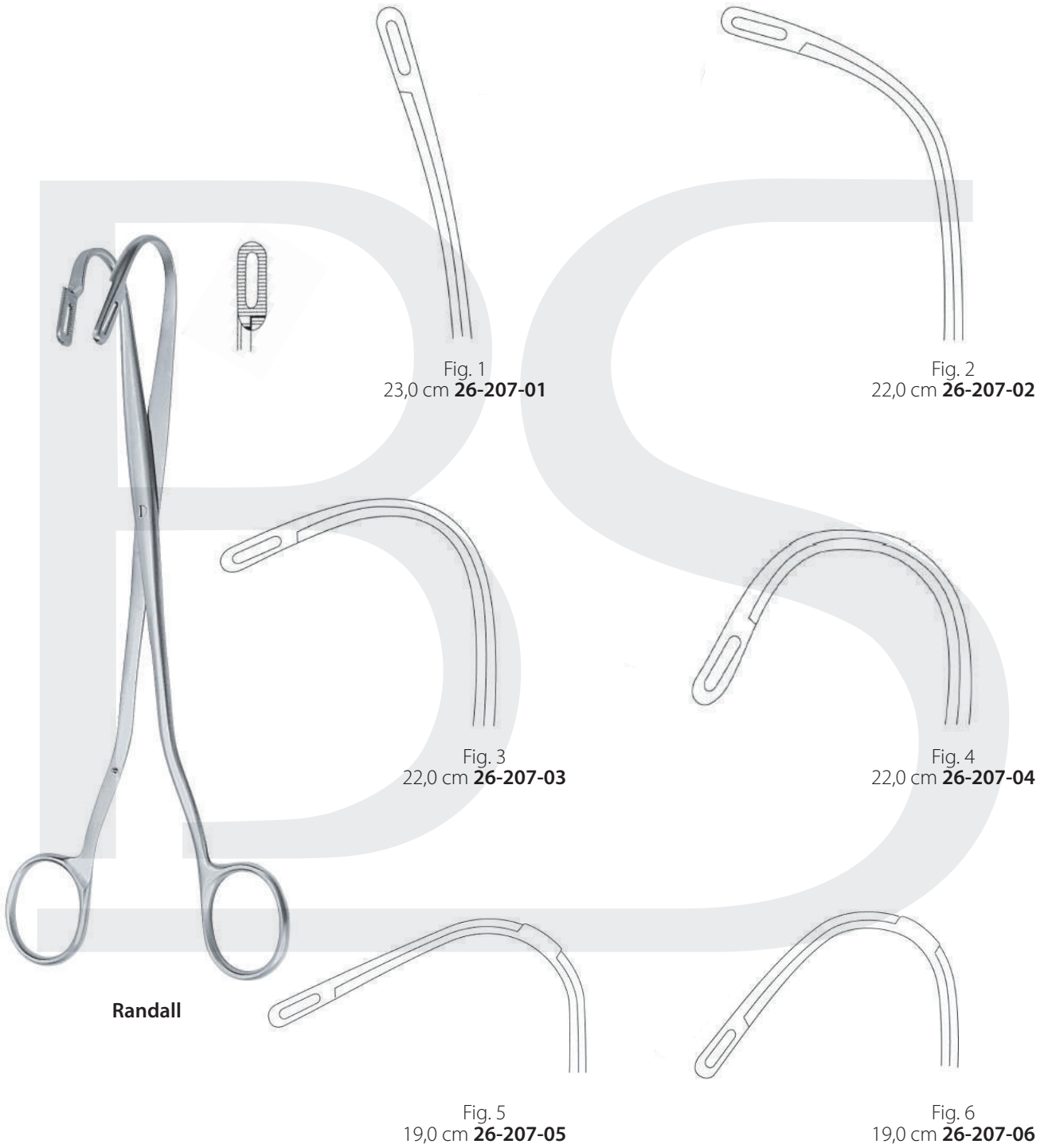

Gallensteinzangen
Gall Stone Forceps



Blake, 20,0 cm



26-240-20



26-241-20



Mayo-Blake
20,0 cm 26-244-20



26-245-20



Mixer
22,0 cm 26-247-22



23,0 cm **Dejardins**



Fig. 1
26-249-01



Fig. 2
26-249-02



schmal /fino
26-249-11



schmal /fino
26-249-12

Gynäkologie
Gynecology

27





Collin für kinder / for children
53x10 mm **27-000-01**



Collin
85x18 mm **27-001-01**
85x30 mm **27-002-01**
100x35 mm **27-002-02**
110x40 mm **27-002-03**



seitliche Stellschraube
lateral fixation screw

Cusco für Jungfrauen / for virgins
75x17 mm **27-003-01**
75x32 mm **27-005-01**
85x35 mm **27-005-02**
100x35 mm **27-005-03**



zentrale Stellschraube
central fixation screw

Cusco
75x17 mm **27-003-02**
75x32 mm **27-006-01**
85x35 mm **27-006-02**
100x35 mm **27-006-03**



seitliche Stellschraube
lateral fixation screw

Cusco, Schweizer Modell
90x22 mm **27-007-01**
100x25 mm **27-007-02**
105x27 mm **27-007-03**



Semm
90x14-18 mm **27-008-01**
100x17-20 mm **27-008-02**
100x25-30 mm **27-008-03**



Seyffert

100x17 mm **27-009-01**
110x33 mm **27-009-02**



Trélat

85x33 mm **27-011-01**
95x33 mm **27-011-02**
115x43 mm **27-011-03**



Grave

75x20 mm **27-013-01**
95x35 mm **27-013-02**
115x35 mm **27-013-03**



Pederson

75x13 mm **27-014-01**
100x22 mm **27-014-02**
120x25 mm **27-014-03**



Sims

65x25/70x30 mm **27-019-01**
70x30/70x35 mm **27-019-02**
85x35/90x40 mm **27-019-03**

Kristeller

Satz/Set 70x15 mm **27-030-00**
Satz/Set 70x27 mm **27-030-01**
Satz/Set 70x30 mm **27-030-02**
Satz/Set 90x36 mm **27-030-03**

unteres Blatt/lower blade
70x15 mm **27-031-00**
70x27 mm **27-031-01**
70x30 mm **27-031-02**
90x36 mm **27-031-03**

oberes Blatt/upper blade
70x15 mm **27-032-00**
70x23 mm **27-032-01**
80x25 mm **27-032-02**
100x32 mm **27-032-03**



Kristeller

unteres Blatt/lower blade
110x18 mm **27-041-01**
110x20 mm **27-041-02**

oberes Blatt/upper blade
115x14 mm **27-042-01**
115x16 mm **27-042-02**

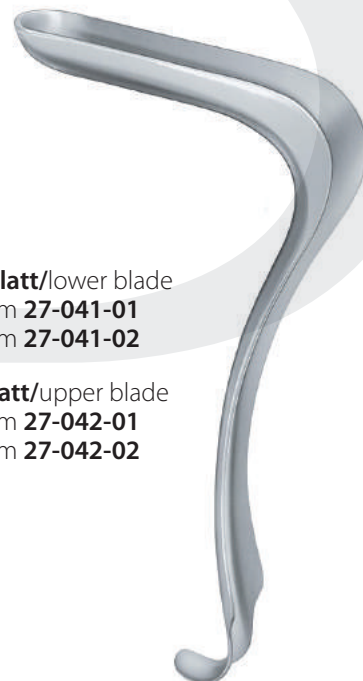

Kristeller

Satz/Set 110x18 mm **27-040-01**
Satz/Set 110x20 mm **27-040-02**

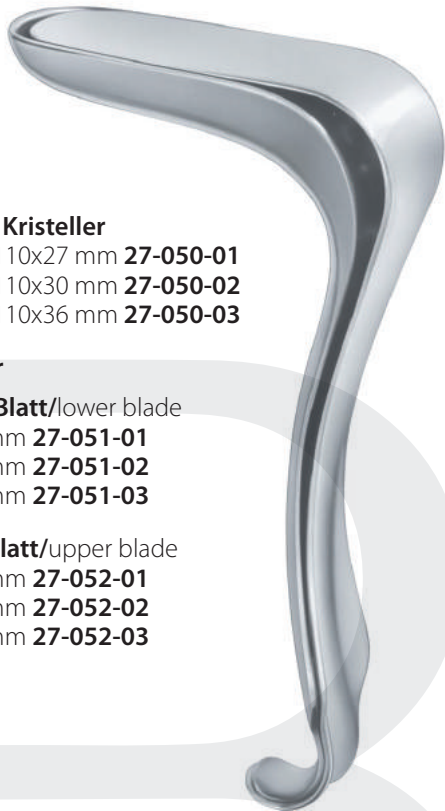

Kristeller
Satz/Set 110x27 mm **27-050-01**
Satz/Set 110x30 mm **27-050-02**
Satz/Set 110x36 mm **27-050-03**

Kristeller

unteres Blatt/lower blade
110x27 mm **27-051-01**
110x30 mm **27-051-02**
110x36 mm **27-051-03**

oberes Blatt/upper blade
115x23 mm **27-052-01**
115x26 mm **27-052-02**
115x32 mm **27-052-03**

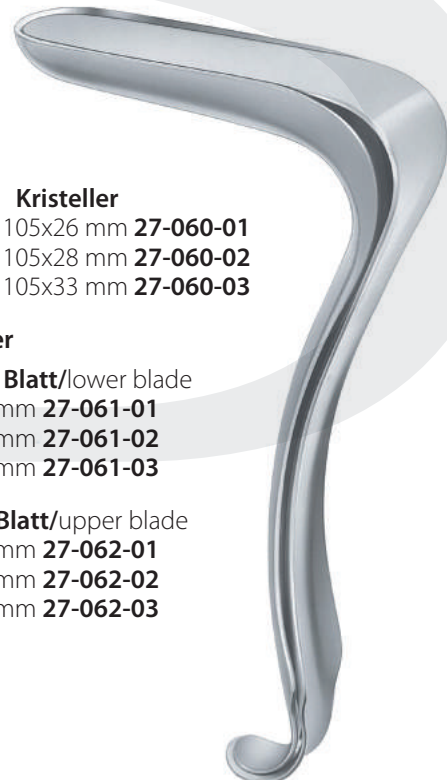
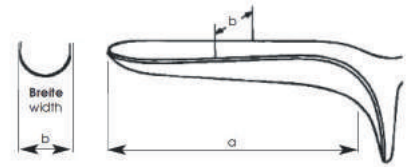

Kristeller
Satz/Set 105x26 mm **27-060-01**
Satz/Set 105x28 mm **27-060-02**
Satz/Set 105x33 mm **27-060-03**

Kristeller

unteres Blatt/lower blade
105x26 mm **27-061-01**
105x28 mm **27-061-02**
105x33 mm **27-061-03**

oberes Blatt/upper blade
115x22 mm **27-062-01**
115x24 mm **27-062-02**
115x29 mm **27-062-03**



Kristeller "Wiener Modell"

unteres Blatt/lower blade

110x20 mm **27-066-01**

110x30 mm **27-066-02**

110x36 mm **27-066-03**

oberes Blatt/upper blade

110x20 mm **27-067-01**

110x30 mm **27-067-02**

110x36 mm **27-067-03**

Kristeller "Wiener Modell"

Satz/Set 110x20 mm 27-065-01

Satz/Set 110x30 mm 27-065-02

Satz/Set 110x36 mm 27-065-03



Kallmorgen

unteres Blatt/lower blade

70x40 mm **27-071-01**

90x40 mm **27-071-02**

oberes Blatt/upper blade

70x37 mm **27-072-01**

90x37 mm **27-072-02**

Kallmorgen

Satz/Set 70x40 mm 27-070-01

Satz/Set 90x40 mm 27-070-02



Doyen
60x45 mm **27-081-01**
90x45 mm **27-081-02**
112x45 mm **27-081-03**

Doyen
60x30 mm **27-081-60**
70x30 mm **27-081-70**
80x30 mm **27-081-80**

Doyen
55x35 mm **27-082-01**
85x35 mm **27-082-02**
115x35 mm **27-082-03**

55x45 mm **27-083-01**
85x45 mm **27-083-02**
115x45 mm **27-083-03**
160x45 mm **27-083-04**

55x60 mm **27-084-01**
85x60 mm **27-084-02**
115x60 mm **27-084-03**
160x60 mm **27-084-04**

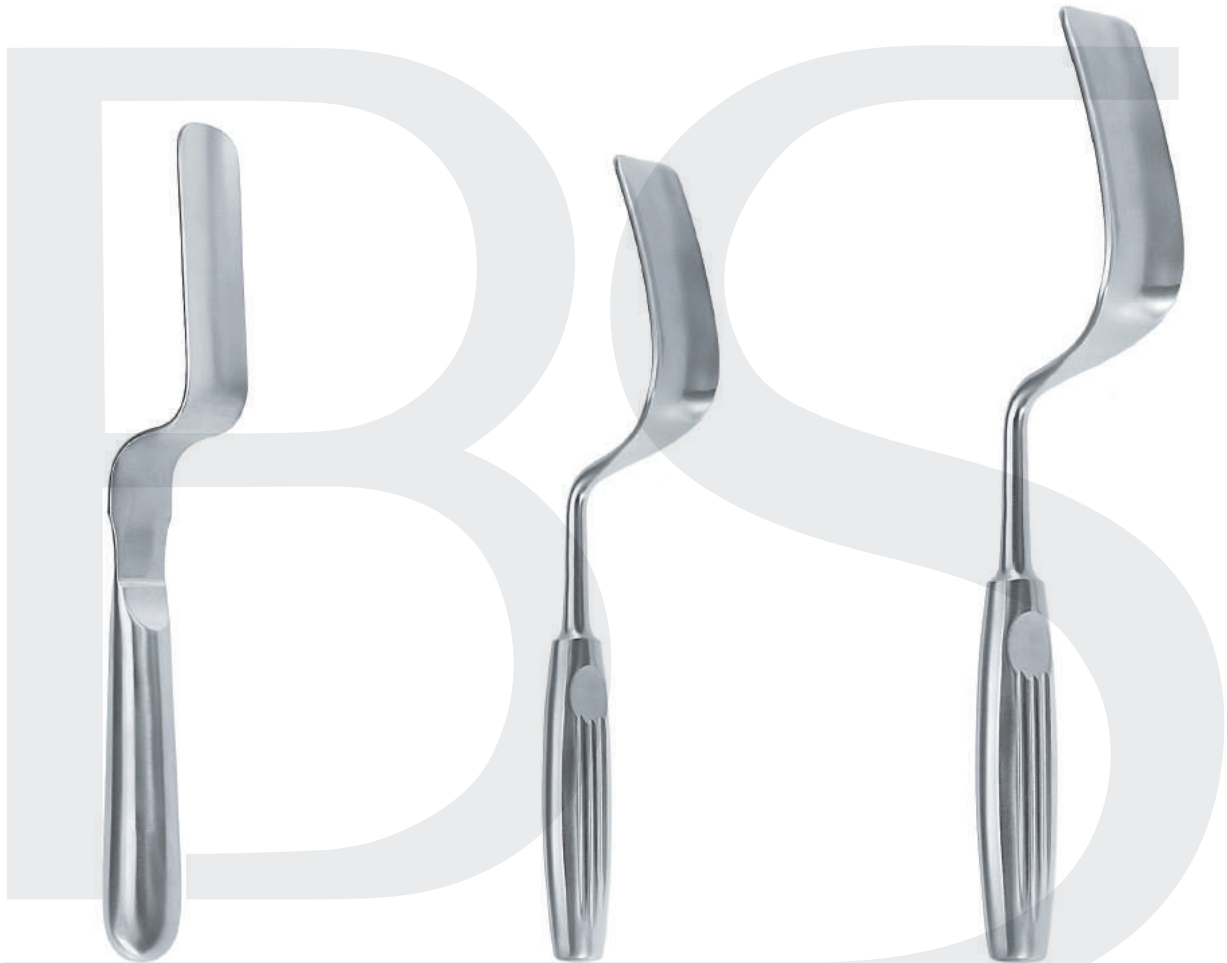

Landau

100x28 mm **27-086-28**
110x38 mm **27-086-38**

Breisky

100x20 mm **27-087-20**
100x25 mm **27-087-25**
100x30 mm **27-087-30**
100x35 mm **27-087-35**
100x40 mm **27-087-40**

Breisky

160x40 mm **27-089-40**
180x40 mm **27-090-40**

130x20 mm **27-088-20**
130x25 mm **27-088-25**
130x30 mm **27-088-30**
130x35 mm **27-088-35**
130x40 mm **27-088-40**

Scheidenspekula
Vaginal Specula



80x30 mm **27-092-01**



55x40/60 mm **27-092-04**



85x35 mm **27-092-02**



70x45/70 mm **27-092-05**



90x40 mm **27-092-03**



Gewicht, allein
Weight only
400 gr. **27-092-10**
800 gr. **27-092-11**



Griff, alleine
Handle only
27-092-12

Scherback, komplett/complete

27-092-00

Satz bestehend aus:
Set consisting of:

- 27-092-01 Blatt/blade**
- 27-092-02 Blatt/blade**
- 27-092-03 Blatt/blade**
- 27-092-04 Blatt/blade**
- 27-092-10 Gewicht/weight**
- 27-092-12 Griff/handle**



Auvard
75x42-40 mm **27-093-01**
105x43-40 mm **27-093-02**



21,0 cm Weissbarth, komplett
80x28 mm **27-094-28**
85x42 mm **27-094-42**

Auffangsieb, allein
collecting filter only
27-094-99



O'Sullivan-O'Connor, komplett
27-095-00



Friedmann
15,5 cm 27-096-00

6,0 mm



Kogan
24,0 cm 27-097-24



**Kogan
mit Sperre/with ratchet**
24,0 cm 27-098-24

Uterus-Dilatatoren
Uterine Dilators



Hegar			
Ø	Ø		
1,0 mm	27-100-01	1,5 mm	27-105-01
2,0 mm	27-100-02	2,5 mm	27-105-02
3,0 mm	27-100-03	3,5 mm	27-105-03
4,0 mm	27-100-04	4,5 mm	27-105-04
5,0 mm	27-100-05	5,5 mm	27-105-05
6,0 mm	27-100-06	6,5 mm	27-105-06
7,0 mm	27-100-07	7,5 mm	27-105-07
8,0 mm	27-100-08	8,5 mm	27-105-08
9,0 mm	27-100-09	9,5 mm	27-105-09
10,0 mm	27-100-10	10,5 mm	27-105-10
11,0 mm	27-100-11	11,5 mm	27-105-11
12,0 mm	27-100-12	12,5 mm	27-105-12
13,0 mm	27-100-13	13,5 mm	27-105-13
14,0 mm	27-100-14	14,5 mm	27-105-14
15,0 mm	27-100-15	15,5 mm	27-105-15
16,0 mm	27-100-16	16,5 mm	27-105-16
17,0 mm	27-100-17	17,5 mm	27-105-17
18,0 mm	27-100-18		
19,0 mm	27-100-19		
20,0 mm	27-100-20		
21,0 mm	27-100-21		
22,0 mm	27-100-22		
23,0 mm	27-100-23		
24,0 mm	27-100-24		
25,0 mm	27-100-25		
26,0 mm	27-100-26		
27,0 mm	27-100-27		
28,0 mm	27-100-28		
29,0 mm	27-100-29		
30,0 mm	27-100-30		
32,0 mm	27-100-32		
34,0 mm	27-100-34		



27-106-14
Satz mit 14 Stück
Set with 14 pieces
4,0 - 17,0 mm
im Metalletui/in metal case

27-106-26
Satz mit 26 Stück
Set with 26 pieces
1,0 - 26,0 mm
im Metalletui/in metal case



Hegar

Ø

1- 2 mm	27-110-02
3- 4 mm	27-110-04
5- 6 mm	27-110-06
7- 8 mm	27-110-08
9-10 mm	27-110-10
11-12 mm	27-110-12
13-14 mm	27-110-14
15-16 mm	27-110-16
17-18 mm	27-110-18
19-20 mm	27-110-20
21-22 mm	27-110-22
23-24 mm	27-110-24
25-26 mm	27-100-26



27-111-08

Satz mit 8 Stück

Set with 8 pieces

Ø3,0/4,0 - 17,0/18,0 mm

mit Stoffrolle

in canvas roll

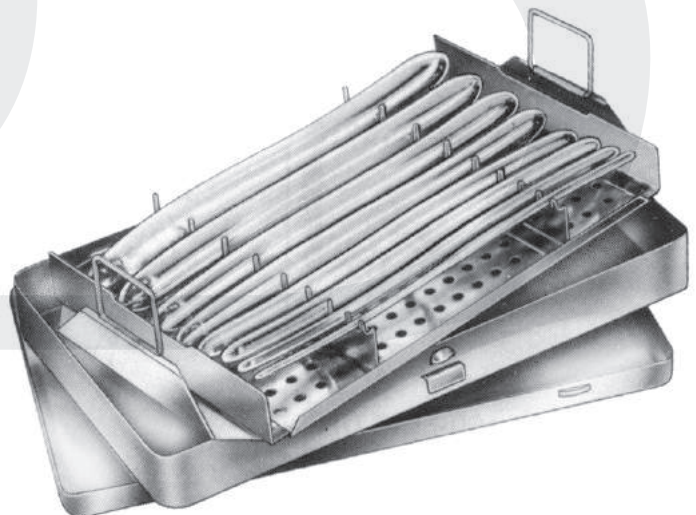

27-112-08

Satz mit 8 Stück

Set with 8 pieces

Ø3,0/4,0 - 17,0/18,0 mm

im Metalletui/in metal case



Hank

Fig.	Ø	
1	4,5/ 5,0 mm	27-117-01
2	5,5/ 6,0 mm	27-117-02
3	6,5/ 7,0 mm	27-117-03
4	7,5/ 8,0 mm	27-117-04
5	8,5/ 9,0 mm	27-117-05
6	9,5/10,0 mm	27-117-06

Hank
27-117-01 - 27-117-06

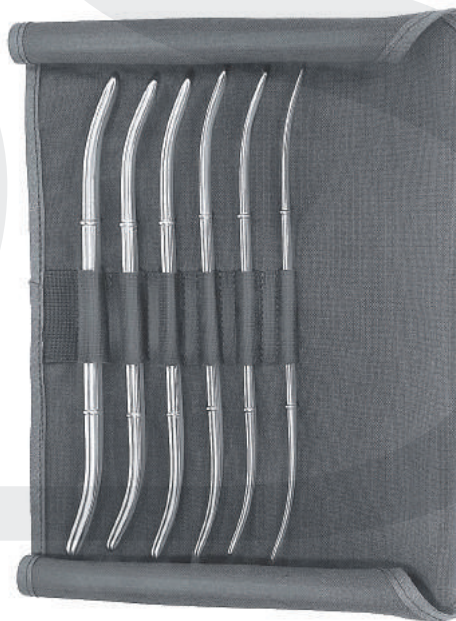

Hank
27-117-99
Satz Fig. 1-6, in Stoffrollentasche
Set Fig. 1-6 in canvas roll



Sims
33,0 cm **27-120-33**
33,0 cm **27-121-33**
biegsam/flexible

Martin
30,0 cm **27-122-32**
30,0 cm **27-123-32**
biegsam/flexible

Braun
27,5 cm **27-200-26**

Blake
26,0 cm **27-202-27**



Schröder
25,0 cm 27-204-25

Braun
25,0 cm 27-206-25



Pozzi
17,0 cm 27-208-17

Duplay
28,0 cm 27-209-28



Pozzi
26,0 cm **27-210-26**



Skene
24,0 cm **27-211-24**



Beacham
26,0 cm **27-212-26**

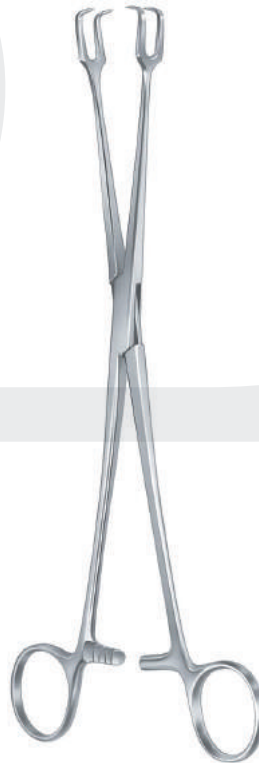

Schröder
24,0 cm **27-214-24**



Schröder
24,0 cm **27-215-24**



Teale
23,0 cm **27-217-23**

3x4 Zähne
3x4 teeth



IOWA
26,0 cm **27-219-26**



Museux, 26,0 cm
27-220-06 - 27-221-10



6,0 mm
gerade/straight **27-220-06**
seitwärts gebogen/curved sideways **27-221-06**



8,0 mm
gerade/straight **27-220-08**
seitwärts gebogen/curved sideways **27-221-08**



10,0 mm
gerade/straight **27-220-10**
seitwärts gebogen/curved sideways **27-221-10**

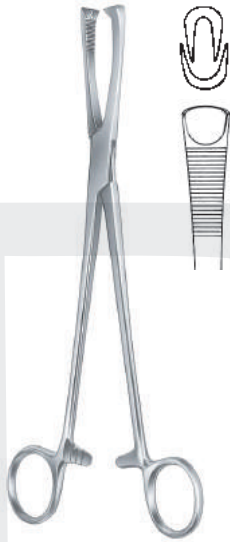

Jacobs
21,0 cm 27-222-21



Pratt
26,0 cm 27-224-28

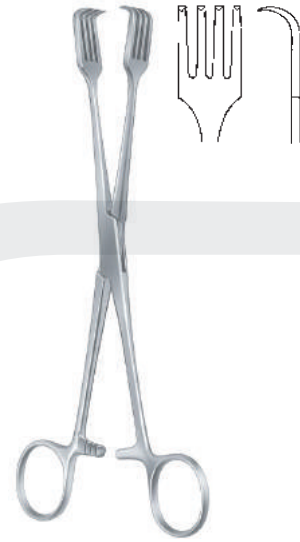

Czerny
21,0 cm 27-226-21

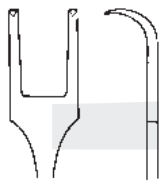

Lahey, 2x2
15,5 cm 27-228-01

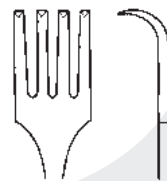

Braun, 4x4
15,5 cm 27-228-03

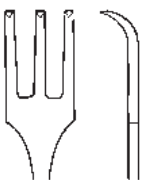

Lahey, 3x3
15,5 cm 27-228-02

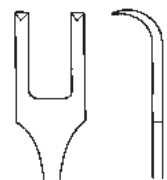

Museux, 2x2
20,0 cm 27-228-04

bewegliche Maulteile
movable jaws



Dartigues
25,5 cm 27-230-22



Sommer
23,5 cm 27-231-23



Collin
25,5 cm 27-232-25

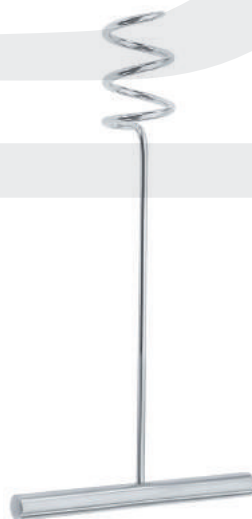

Doyen
16,5 cm 27-233-17



Doyen
17 cm 27-234-17

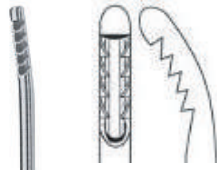

Novak, 24,0 cm
Ø 1,0 mm **27-301-01**
Ø 2,0 mm **27-301-02**
Ø 3,0 mm **27-301-03**
Ø 4,0 mm **27-301-04**

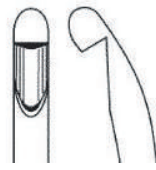

Randall, 24 cm
Ø 4,0 mm **27-303-04**



Kevorkian, 30,0 cm
Ø 4,0 mm **27-305-04**

Absaugküretten
Aspirating Curettes

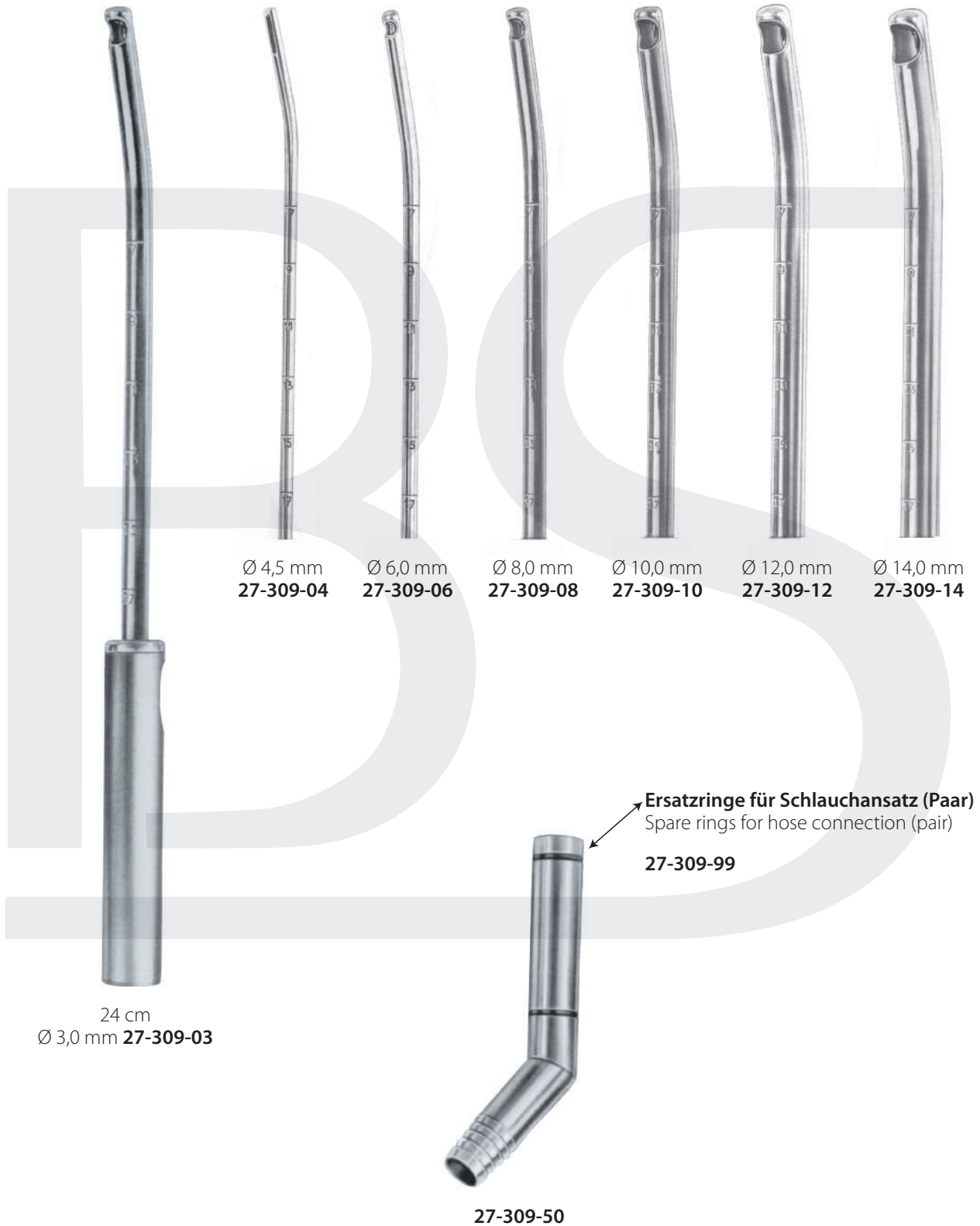

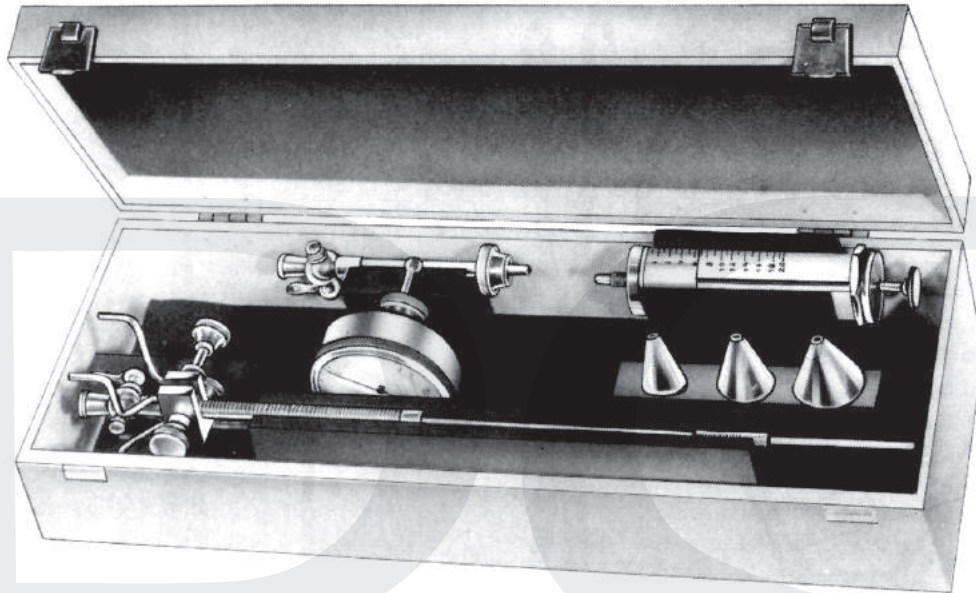

- 27-320-00 Schulze, komplett in Holzetui**
complete in wooden case
- 27-330-00 ohne Manometer**
without Manometer
- 27-340-00 Manometer, allein**
Manometer only
- 27-330-01 Schulze Salpingograph, nur Hauptteil**
Schulze Salpingograph, only main part
- 27-330-02 Schulze Salpingograph, Hauptteil mit 2 Schieber und je 1 Kegel Ø 16/20/25 mm**
Schulze Salpingograph, only main part with 3 conus Ø 16/20/25 mm
- 27-320-07 Kegel allein, klein Ø 16 mm, PTFE**
Cone only, small Ø 16 mm, PTFE
- 27-320-08 Kegel allein, mittel Ø 20 mm, PTFE**
Cone only, medium Ø 20 mm, PTFE
- 27-320-09 Kegel allein, groß Ø 25 mm, PTFE**
Cone only, large Ø 25 mm, PTFE
- 00-844-20 Luer-Spritze, 20ml**
Luer Hypodermic Syringe, 20ml



Faure
21,0 cm **27-401-21**
24,0 cm **27-401-24**



Schubert
21,0 cm **27-402-21**
29,0 cm **27-402-29**



Schubert
26,0 cm **27-403-26**

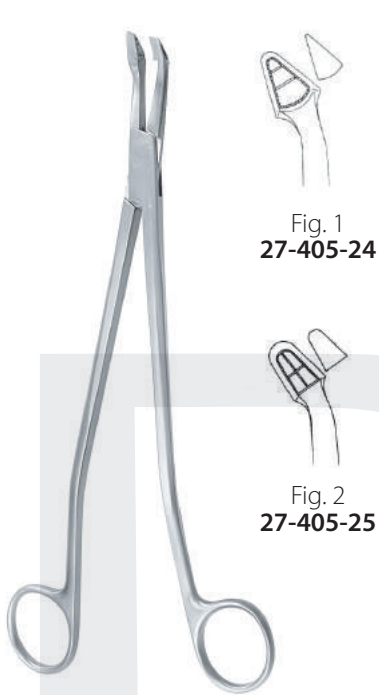

Schumacher, 24,0 cm



Van Doren
mit Sperre/with ratchet
25,0 cm 27-406-25

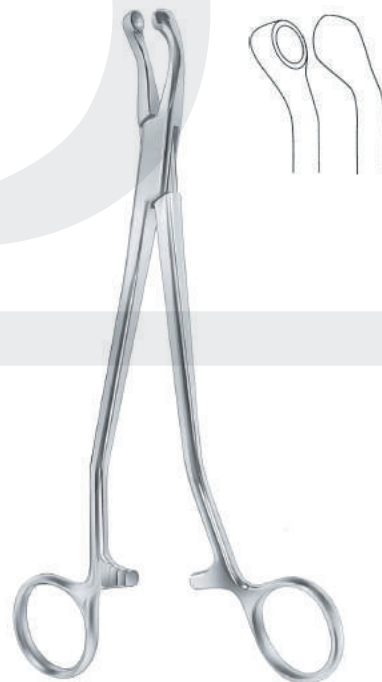

Thoms-Gaylor
S-gebogen/s-curved
24,0 cm 27-407-24



Gelhorn
23,0 cm 27-409-23

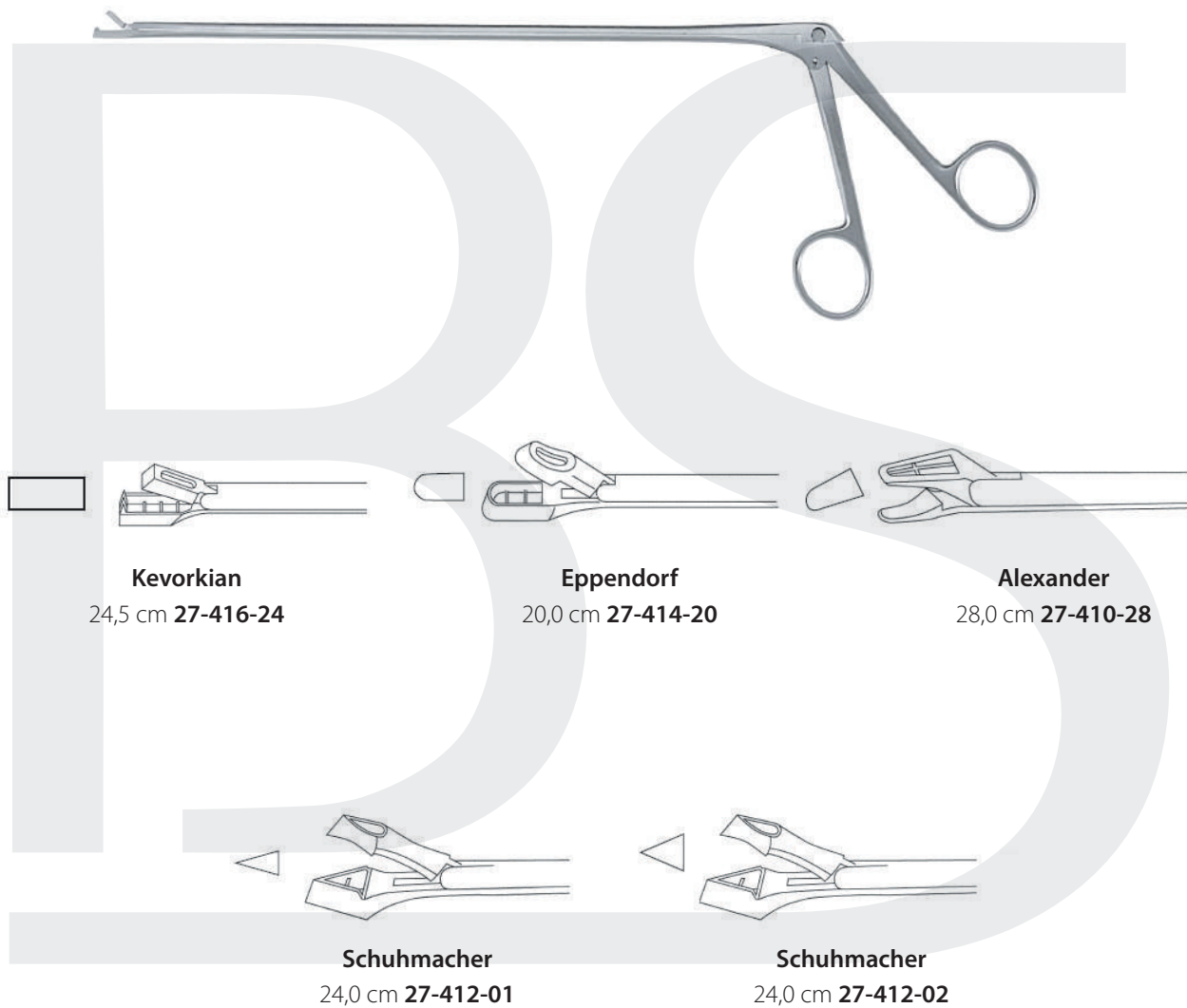

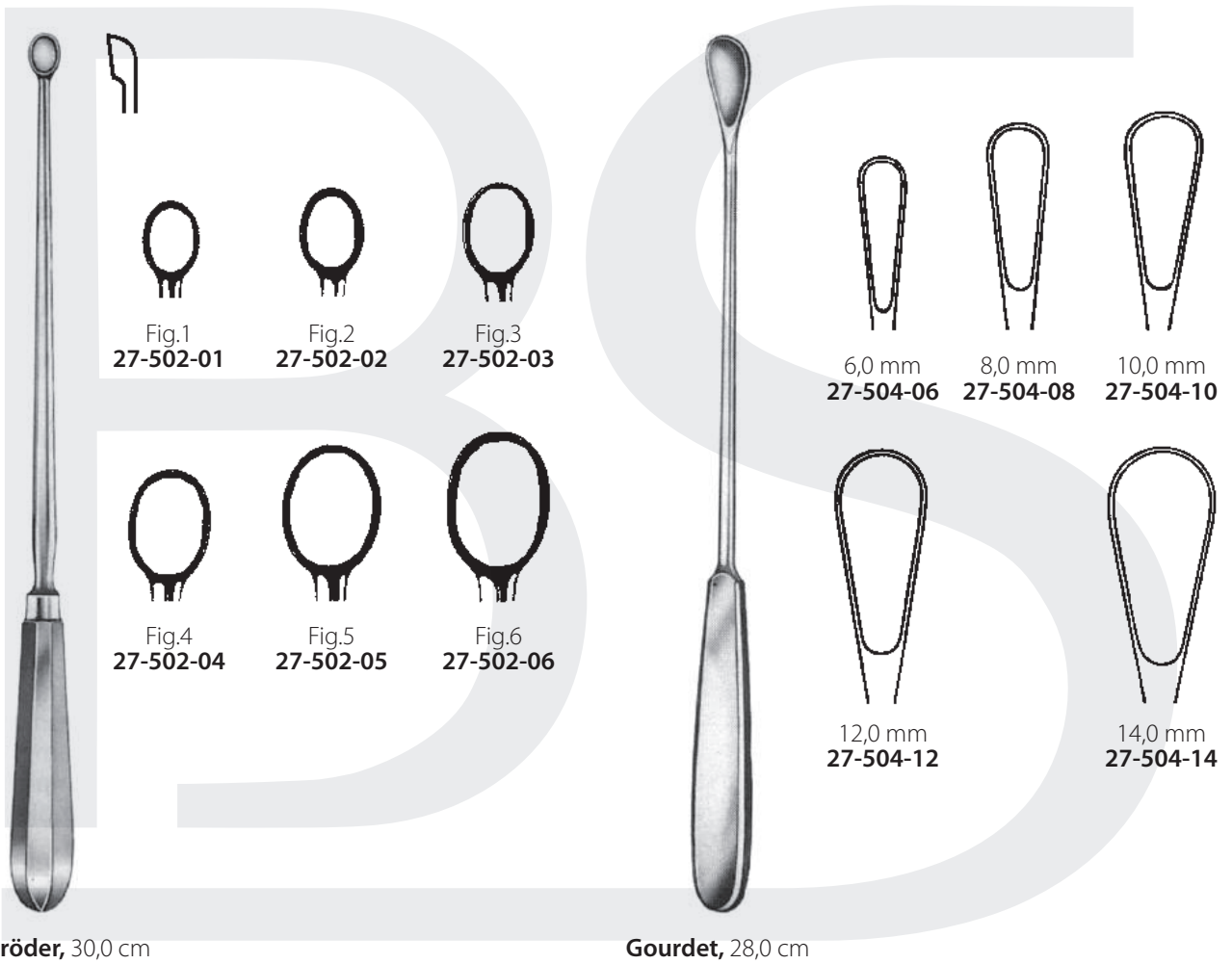

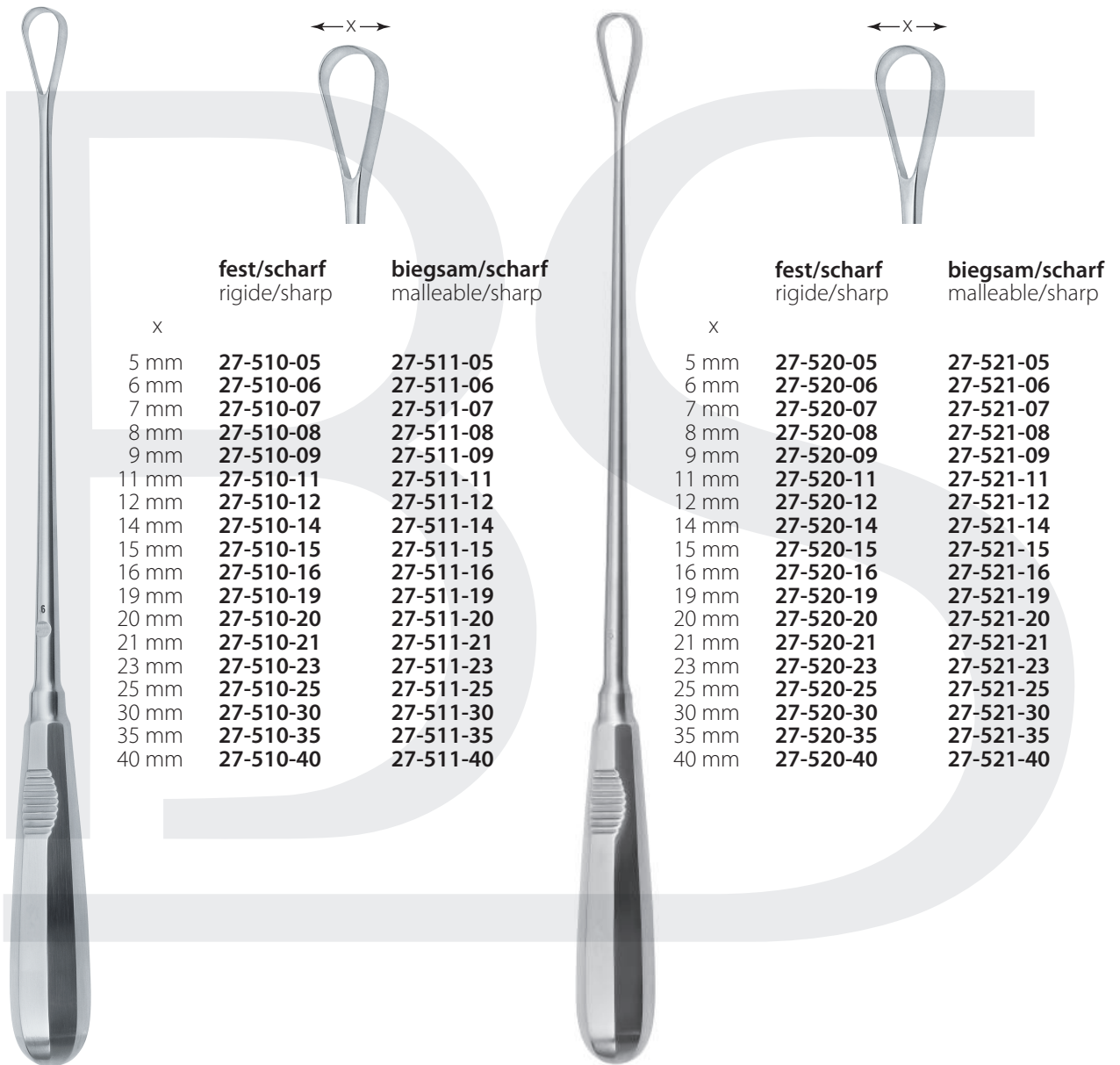

Recamier, ~ 28,0 cm

Sims, ~ 28,0 cm



Martin
34,0 cm 27-701-34



Collin
35,0 cm 27-703-35



Nägele
36,0 cm **27-711-36**
40,0 cm **27-711-40**



Simpson
30,0 cm **27-713-30**
36,0 cm **27-713-36**



Kielland
41,0 cm **27-715-41**

Geburtslöffel
Obstetric Lever



Sellheim
30,0 cm 27-731-28



Green-Armytage
22,0 cm 27-732-21



Collin
9,0 cm 27-737-09



Kane
8,5 cm 27-739-09

Nabelschnurklemmen
Umbilical Cord Clamps



Fig.1

27-750-01
27-751-01
-



Fig.2

27-750-02
27-751-02
27-751-12



Fig.3

27-750-03
27-751-03
27-751-13

ohne Sperre/without ratched
ohne Sperre/without ratched
mit Sperre/with ratched

gerade/straight
gebogen/curved
gebogen/curved



Winter, 29,0 cm
27-750-01 - 27-750-03



Winter, 29,0 cm
27-751-01 - 27-751-03



Winter, 29,0 cm
27-751-12 - 27-751-13



Saenger, 27,5 cm

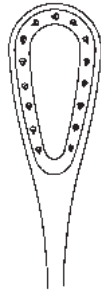

27-752-27

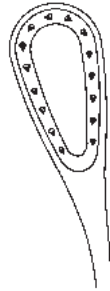

27-753-27



Cuzzi, 30,0 cm



14,0 mm 27-754-14 18,0 mm 27-754-18 20,0 mm 27-754-20

stumpf, Rückseite gerieft
blunt, backside serrated



Pestalozza
30,0 cm 27-756-30

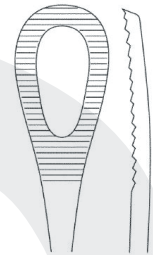

Urologie
Genito-Urinary

28





15,0 cm
28-001-15



20,0 cm
28-001-20



25,0 cm
28-001-25



Magill

Kapsel­f­ass­z­an­gen
Lobe Grasping Forceps



24,5 cm
28-011-24



22,0 cm
28-012-22

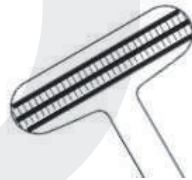

23,5 cm
28-013-23

Faden­f­üh­rungs­z­an­ge
Ligature Carrying Forceps

Kapsel­f­ass­z­an­gen
Lobe Grasping Forceps

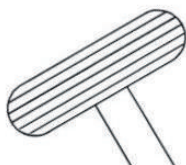

24,0 cm
28-014-24

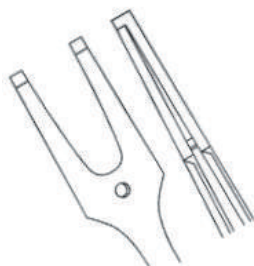

24,5 cm
28-015-24

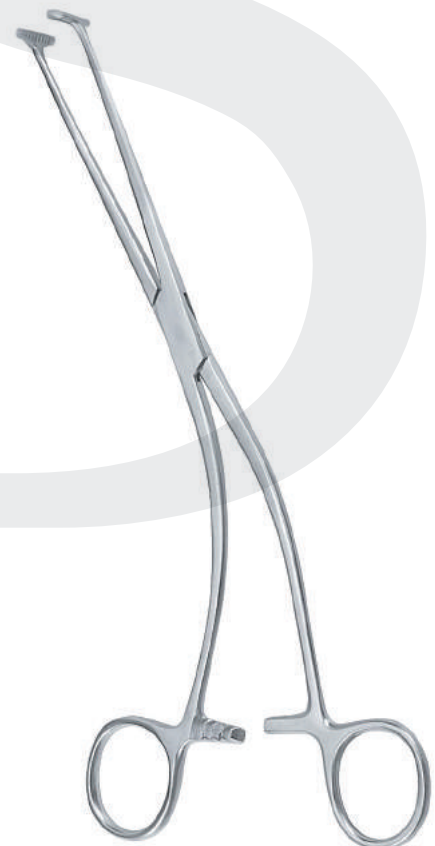

Millin



Blasenhalsspreizer
Bladder Neck Retractor

Millin
28,0 cm **28-020-00**



Blasenspatel
Bladder Spatula

Legueu
27,0 cm **28-021-27**



Stockmann
8,0 cm **28-050-08**



Penisklemme
Penis Seizing Forceps

Strauss
13,0 cm **28-052-13**



COMCO

Ø 8,0 mm	28-062-08
Ø 11,0 mm	28-062-11
Ø 13,0 mm	28-062-13
Ø 16,0 mm	28-062-16
Ø 21,0 mm	28-062-21
Ø 26,0 mm	28-062-26
Ø 32,0 mm	28-062-32

Guyon
Besteck mit 21 Bougies im Etui (Fig. 10-30)
Set of 21 bougies in case (Fig. 10-30)
28-100-00



Maßtabelle Metall Bougies, 25,5 cm
Table of measurements

Charrière	Art.-Nr.
8	28-100-08
9	28-100-09
10	28-100-10
11	28-100-11
12	28-100-12
13	28-100-13
14	28-100-14
15	28-100-15
16	28-100-16
17	28-100-17
18	28-100-18
19	28-100-19
20	28-100-20
21	28-100-21
22	28-100-22
23	28-100-23
24	28-100-24
25	28-100-25
26	28-100-26
27	28-100-27
28	28-100-28
29	28-100-29
30	28-100-30

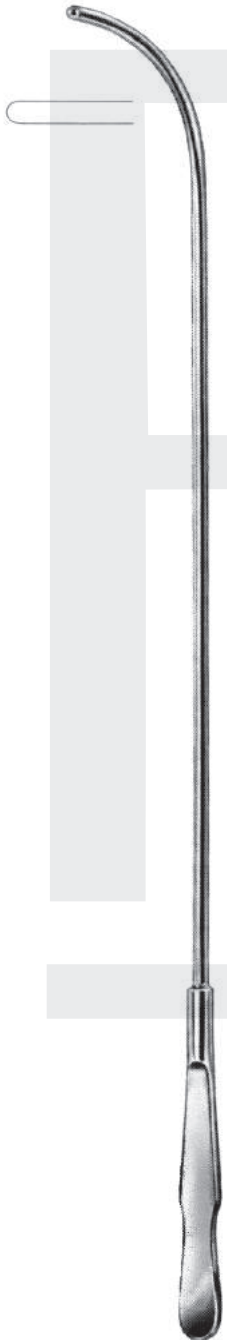

Dittel
Besteck mit 15 Bougies (gerade Nummern)
Set of 15 bougies (even numbers)
28-102-00

Maßtabelle Metall Bougies, 34,5 cm
Table of measurements

Charrière	Art.-Nr.
8	28-102-08
9	28-102-09
10	28-102-10
11	28-102-11
12	28-102-12
13	28-102-13
14	28-102-14
15	28-102-15
16	28-102-16
17	28-102-17
18	28-102-18
19	28-102-19
20	28-102-20
21	28-102-21
22	28-102-22
23	28-102-23
24	28-102-24
25	28-102-25
26	28-102-26
27	28-102-27
28	28-102-28
29	28-102-29
30	28-102-30
32	28-102-32
34	28-102-34
36	28-102-36

Dittel, 34,5 cm



Maßtabelle Metall Bougies, Größe 19,5 cm
Table of measurements

Charrière	Art.-Nr.
8	28-104-08
9	28-104-09
10	28-104-10
11	28-104-11
12	28-104-12
13	28-104-13
14	28-104-14
15	28-104-15
16	28-104-16
17	28-104-17
18	28-104-18
19	28-104-19
20	28-104-20
21	28-104-21
22	28-104-22
23	28-104-23
24	28-104-24
25	28-104-25
26	28-104-26
27	28-104-27
28	28-104-28
29	28-104-29
30	28-104-30

Dittel, 19,0 cm

Maßtabelle
Metall Katheter für Frauen, 15,0 cm
Table of measurements
Female Catheters, metal, 15,0 cm

Charrière Art.-Nr.

6	28-110-06
7	28-110-07
8	28-110-08
9	28-110-09
10	28-110-10
11	28-110-11
12	28-110-12
14	28-110-14
16	28-110-16
18	28-110-18
20	28-110-20
22	28-110-22
24	28-110-24

Maßtabelle
Metall Katheter für Männer, 29,0 cm
Table of measurements
Male Catheters, metal, 29,5 cm

Charrière Art.-Nr.

8	28-112-08
10	28-112-10
12	28-112-12
14	28-112-14
16	28-112-16
18	28-112-18
20	28-112-20

Katheter-Einführinstrument
Catheter introducer
36,0 cm **28-115-02**

Knochenchirurgie
Bone Surgery

31





Citelli, 17,0 cm

- n 1,0 mm **31-000-10**
- n 2,0 mm **31-000-20**
- n 3,5 mm **31-000-35**

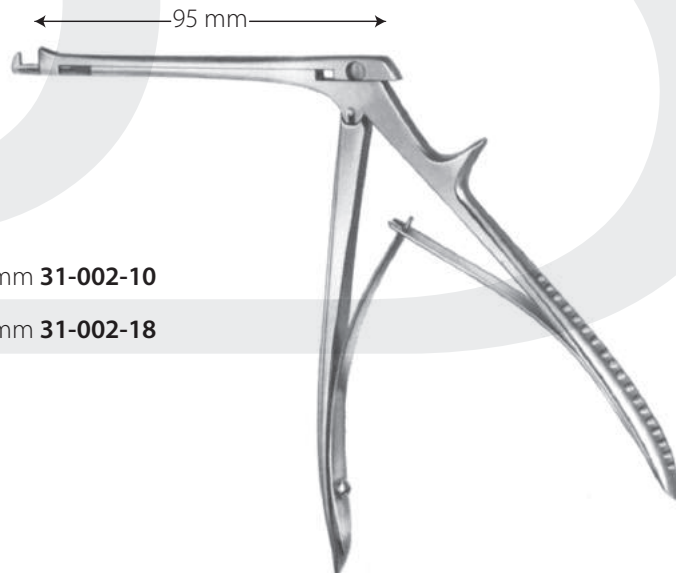



- n 1,0 mm **31-002-10**
- n 1,8 mm **31-002-18**

Citelli-Beyer





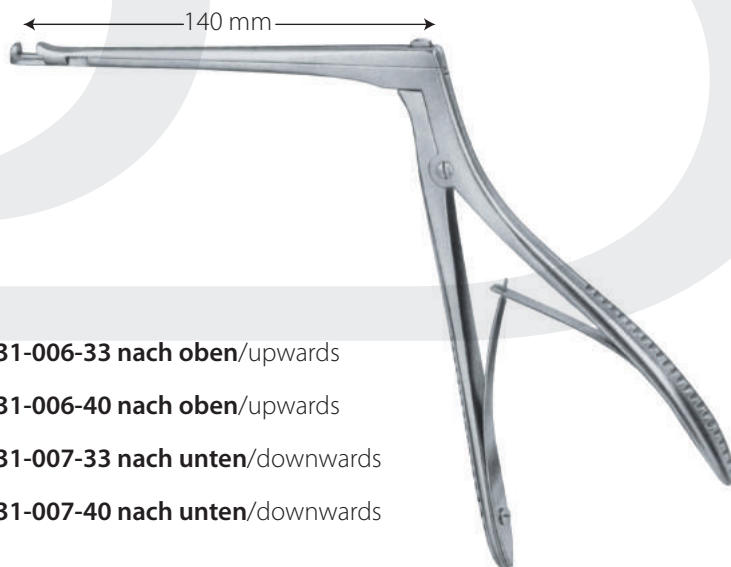

Kerrison, 17,0 cm

-  3,0 mm **31-004-03**
-  4,0 mm **31-004-04**
-  5,0 mm **31-004-05**
-  6,0 mm **31-004-06**



Hajek-Kofler, 14,0 cm

-  3,3 mm **31-006-33 nach oben/upwards**
-  4,0 mm **31-006-40 nach oben/upwards**
-  3,3 mm **31-007-33 nach unten/downwards**
-  4,0 mm **31-007-40 nach unten/downwards**

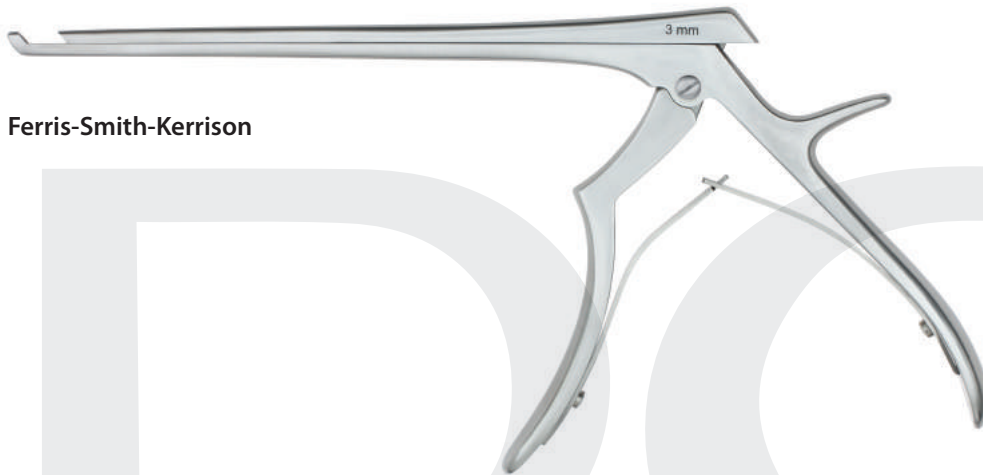

Ferris-Smith-Kerrison

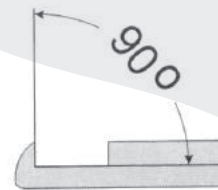
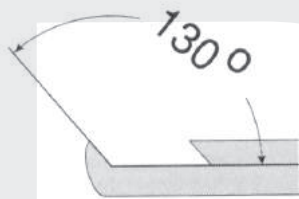
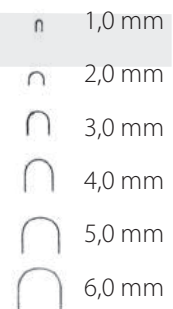

Art.-Nr. item no. standard	Art.-Nr. item no. black coated	Arbeitslänge length of shaft	Schnittbreite bite	Art.-Nr. item no. standard	Art.-Nr. item no. black coated	Arbeitslänge length of shaft	Schnittbreite bite
31-014-01	31-014-01 B	180 mm	1,0 mm	31-016-01	31-016-01 B	180 mm	1,0 mm
31-014-02	31-014-02 B	180 mm	2,0 mm	31-016-02	31-016-02 B	180 mm	2,0 mm
31-014-03	31-014-03 B	180 mm	3,0 mm	31-016-03	31-016-03 B	180 mm	3,0 mm
31-014-04	31-014-04 B	180 mm	4,0 mm	31-016-04	31-016-04 B	180 mm	4,0 mm
31-014-05	31-014-05 B	180 mm	5,0 mm	31-016-05	31-016-05 B	180 mm	5,0 mm
31-014-06	31-014-06 B	180 mm	6,0 mm	31-016-06	31-016-06 B	180 mm	6,0 mm
31-014-11	31-014-11 B	200 mm	1,0 mm	31-016-11	31-016-11 B	200 mm	1,0 mm
31-014-12	31-014-12 B	200 mm	2,0 mm	31-016-12	31-016-12 B	200 mm	2,0 mm
31-014-13	31-014-13 B	200 mm	3,0 mm	31-016-13	31-016-13 B	200 mm	3,0 mm
31-014-14	31-014-14 B	200 mm	4,0 mm	31-016-14	31-016-14 B	200 mm	4,0 mm
31-014-15	31-014-15 B	200 mm	5,0 mm	31-016-15	31-016-15 B	200 mm	5,0 mm
31-014-16	31-014-16 B	200 mm	6,0 mm	31-016-16	31-016-16 B	200 mm	6,0 mm
31-014-21	31-014-21 B	230 mm	1,0 mm	31-016-21	31-016-21 B	230 mm	1,0 mm
31-014-22	31-014-22 B	230 mm	2,0 mm	31-016-22	31-016-22 B	230 mm	2,0 mm
31-014-23	31-014-23 B	230 mm	3,0 mm	31-016-23	31-016-23 B	230 mm	3,0 mm
31-014-24	31-014-24 B	230 mm	4,0 mm	31-016-24	31-016-24 B	230 mm	4,0 mm
31-014-25	31-014-25 B	230 mm	5,0 mm	31-016-25	31-016-25 B	230 mm	5,0 mm
31-014-26	31-014-26 B	230 mm	6,0 mm	31-016-26	31-016-26 B	230 mm	6,0 mm

zerlegbar
detachable

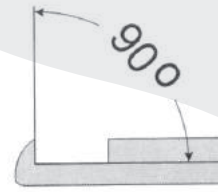
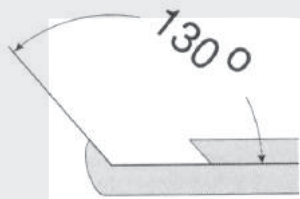
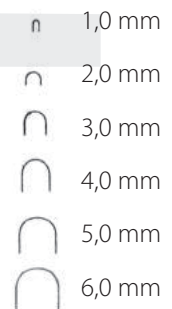

Art.-Nr. item no. standard	Art.-Nr. item no. black coated	Arbeitslänge length of shaft	Schnittbreite bite	Art.-Nr. item no. standard	Art.-Nr. item no. black coated	Arbeitslänge length of shaft	Schnittbreite bite
31-014-51	31-014-51 B	180 mm	1,0 mm	31-016-51	31-016-51 B	180 mm	1,0 mm
31-014-52	31-014-52 B	180 mm	2,0 mm	31-016-52	31-016-52 B	180 mm	2,0 mm
31-014-53	31-014-53 B	180 mm	3,0 mm	31-016-53	31-016-53 B	180 mm	3,0 mm
31-014-54	31-014-54 B	180 mm	4,0 mm	31-016-54	31-016-54 B	180 mm	4,0 mm
31-014-55	31-014-55 B	180 mm	5,0 mm	31-016-55	31-016-55 B	180 mm	5,0 mm
31-014-56	31-014-56 B	180 mm	6,0 mm	31-016-56	31-016-56 B	180 mm	6,0 mm
31-014-71	31-014-71 B	200 mm	1,0 mm	31-016-71	31-016-71 B	200 mm	1,0 mm
31-014-72	31-014-72 B	200 mm	2,0 mm	31-016-72	31-016-72 B	200 mm	2,0 mm
31-014-73	31-014-73 B	200 mm	3,0 mm	31-016-73	31-016-73 B	200 mm	3,0 mm
31-014-74	31-014-74 B	200 mm	4,0 mm	31-016-74	31-016-74 B	200 mm	4,0 mm
31-014-75	31-014-75 B	200 mm	5,0 mm	31-016-75	31-016-75 B	200 mm	5,0 mm
31-014-76	31-014-76 B	200 mm	6,0 mm	31-016-76	31-016-76 B	200 mm	6,0 mm
31-014-81	31-014-81 B	230 mm	1,0 mm	31-016-81	31-016-81 B	230 mm	1,0 mm
31-014-82	31-014-82 B	230 mm	2,0 mm	31-016-82	31-016-82 B	230 mm	2,0 mm
31-014-83	31-014-83 B	230 mm	3,0 mm	31-016-83	31-016-83 B	230 mm	3,0 mm
31-014-84	31-014-84 B	230 mm	4,0 mm	31-016-84	31-016-84 B	230 mm	4,0 mm
31-014-85	31-014-85 B	230 mm	5,0 mm	31-016-85	31-016-85 B	230 mm	5,0 mm
31-014-86	31-014-86 B	230 mm	6,0 mm	31-016-86	31-016-86 B	230 mm	6,0 mm

← 250 mm →

5,5 mm



Syvert
130°, 5,5 mm **31-026-55**

← 180 mm →

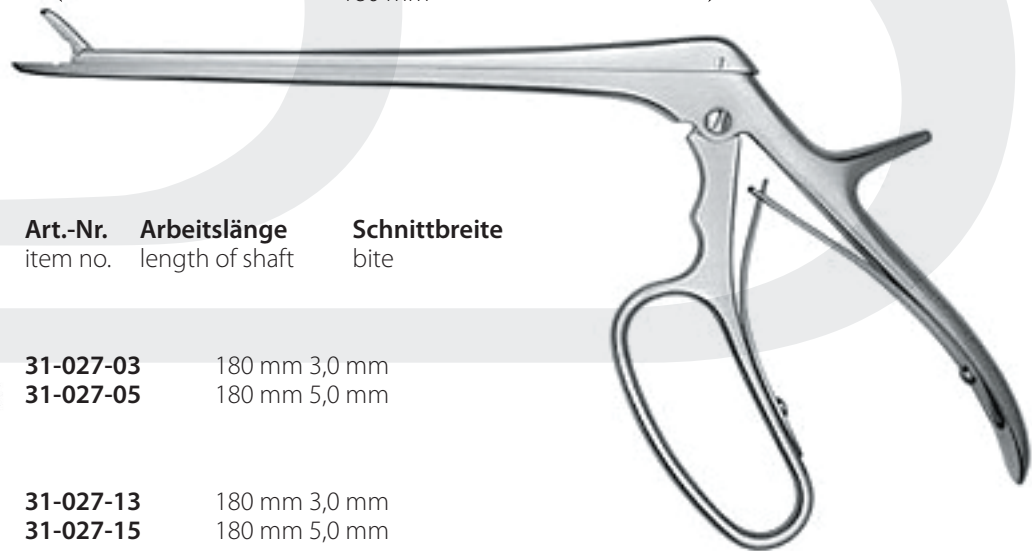

Art.-Nr. item no.	Arbeitslänge length of shaft	Schnittbreite bite
----------------------	---------------------------------	-----------------------



31-027-03	180 mm	3,0 mm
31-027-05	180 mm	5,0 mm



31-027-13	180 mm	3,0 mm
31-027-15	180 mm	5,0 mm



31-027-23	180 mm	3,0 mm
31-027-25	180 mm	5,0 mm

Ferris-Smith-Kerrison

180 mm

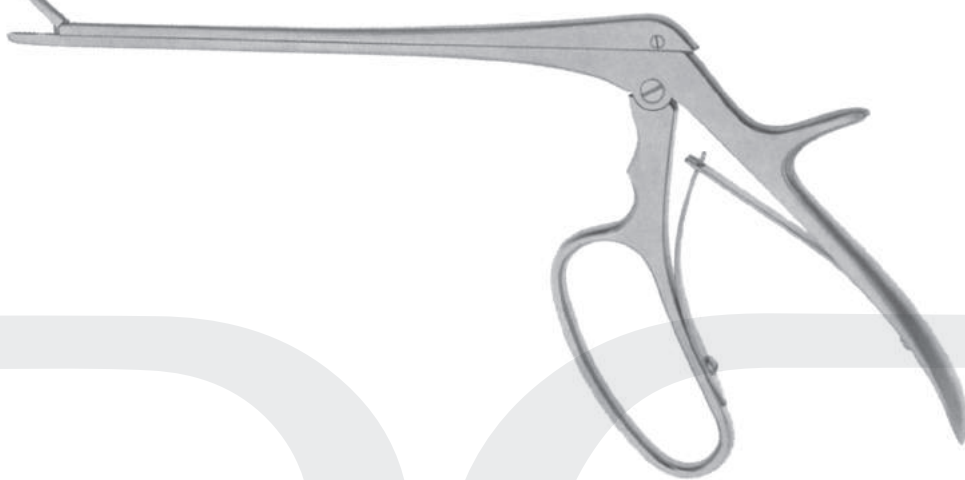

Ferris-Smith-Cushing

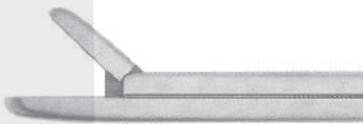

gerade
straight

- 31-028-02** 2 x 10 mm
- 31-028-03** 3 x 10 mm
- 31-028-04** 4 x 10 mm
- 31-028-05** 5 x 10 mm

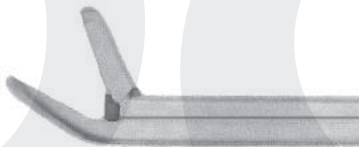

aufgebogen
curved on flat

- 31-028-12** 2 x 10 mm
- 31-028-13** 3 x 10 mm
- 31-028-14** 4 x 10 mm



abwärts gebogen
curved down

- 31-028-22** 2 x 10 mm
- 31-028-23** 3 x 10 mm
- 31-028-24** 4 x 10 mm

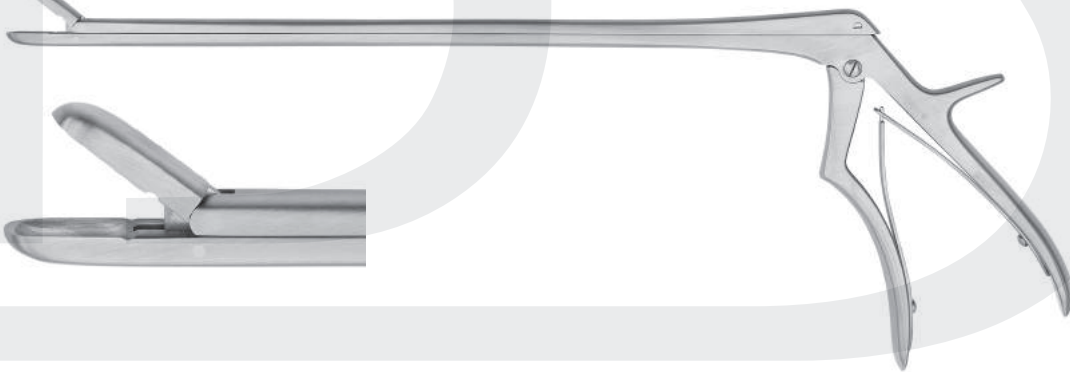

31-029-80

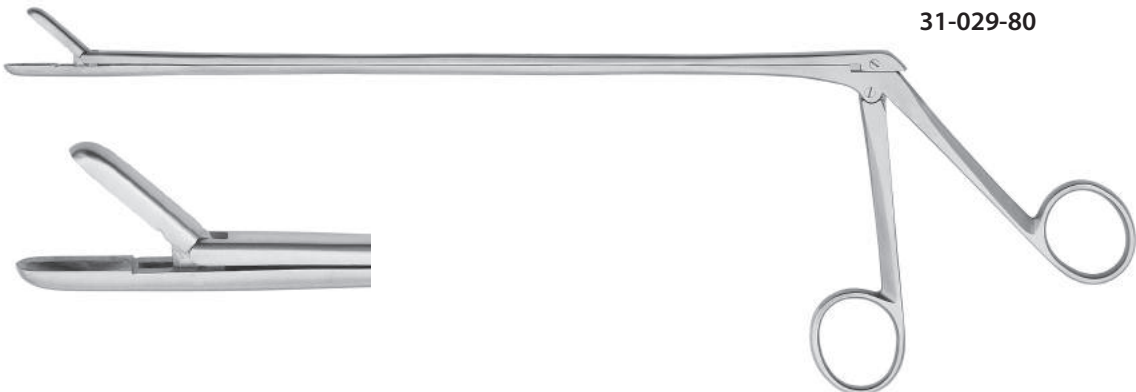

31-030-25

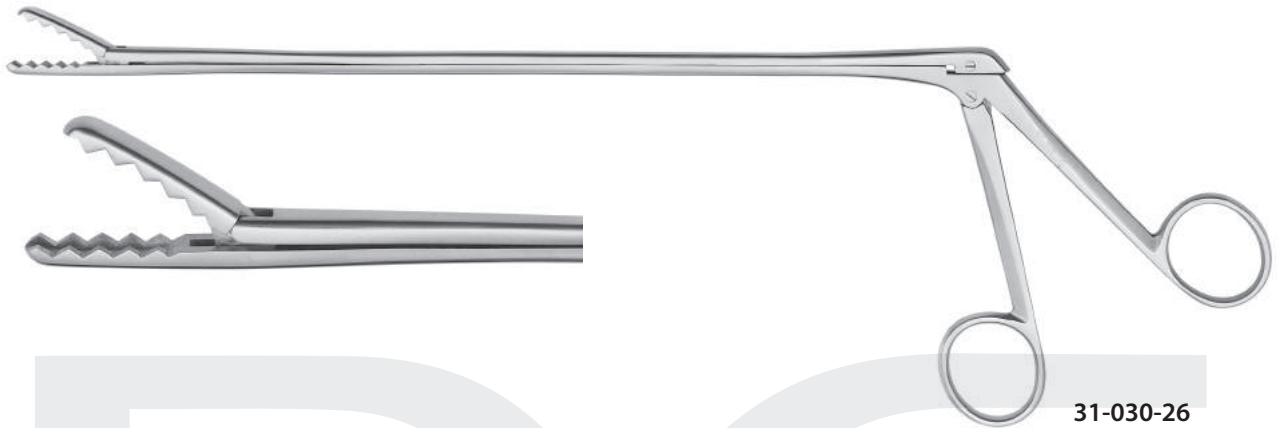

31-030-26

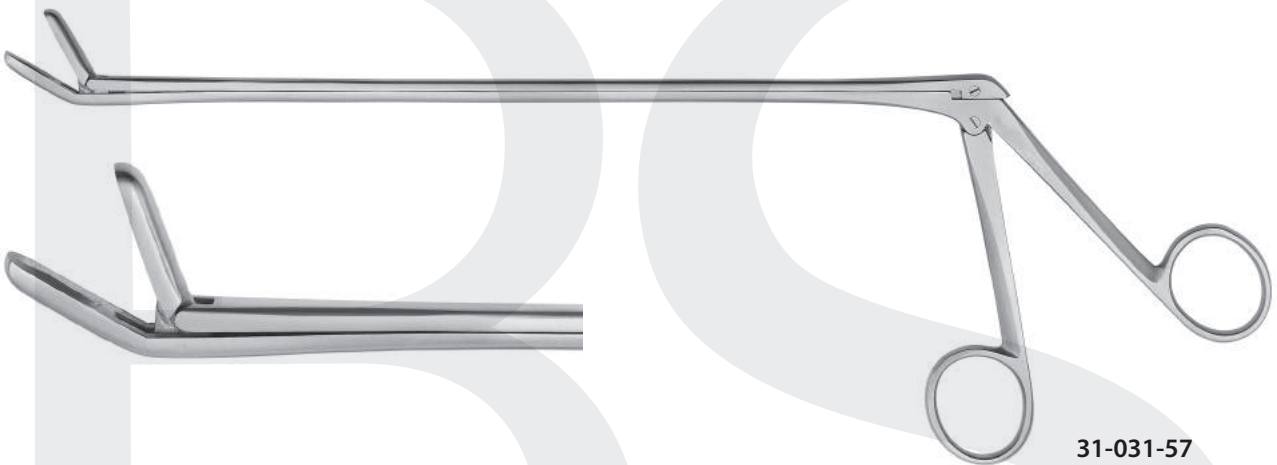

31-031-57

← 120 mm →



Weil-Blakesley



2,5 mm



3,0 mm



3,6 mm



4,2 mm



4,8 mm



5,8 mm



gerade
straight

31-036-25

31-036-30

31-036-36

31-036-42

31-036-48

31-036-58



45°

31-037-25

31-037-30

31-037-36

31-037-42

31-037-48

31-037-58



90°

31-037-63

31-037-66

31-037-72

31-037-78

Nasenzangen, Tonsillenzangen
Nasal Forceps, Tonsil Forceps



Myles

 2,0 mm **31-038-02**

 3,0 mm **31-038-03**

 4,0 mm **31-038-04**



Hajek

 2,5 mm **31-039-25**

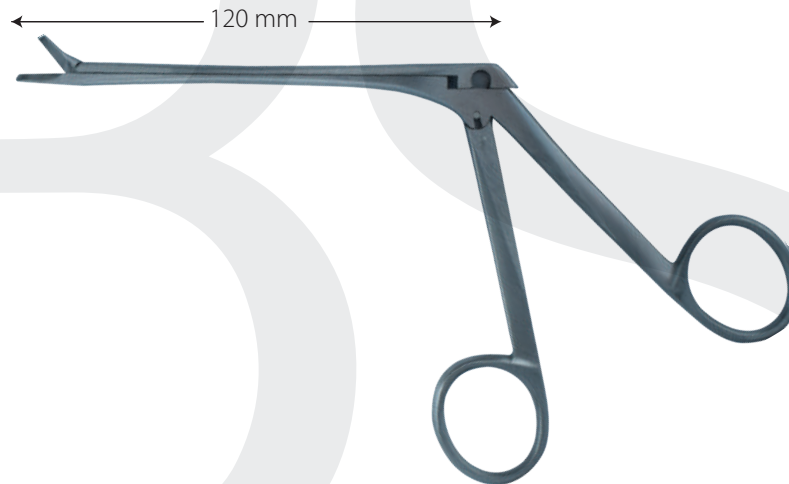



Hartmann



Schmeden

 5,0 mm **31-040-05**

 7,0 mm **31-040-07**

 9,0 mm **31-040-09**

 11,0 mm **31-040-11**

 13,0 mm **31-040-13**

 15,0 mm **31-040-15**

 17,0 mm **31-040-17**

 6,0 mm **31-041-12**

 8,0 mm **31-041-14**



Watson-Williams
31-042-01



Weil
31-042-02



Watson-Williams
31-042-03



31-044-03



31-045-03



Takahashi

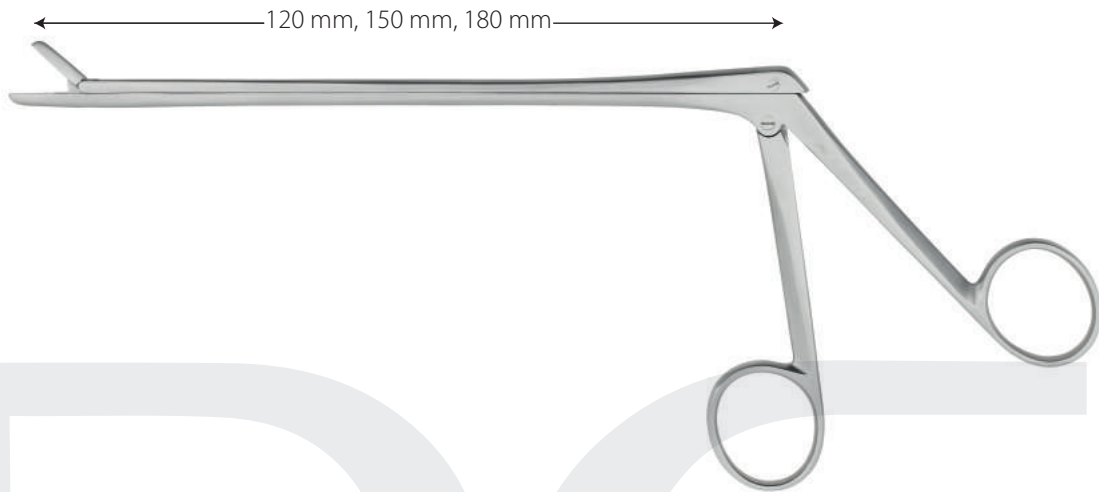

Art.-Nr. item-no.	Bezeichnung description	Maulgröße size of jaws	Schaftlänge length of shaft
31-046-02	Cushing	2 x 10 mm	120 mm
31-050-02	Cushing	2 x 10 mm	150 mm
31-066-02	Cushing	2 x 10 mm	180 mm
31-046-03	Love Grünewald	3 x 10 mm	120 mm
31-050-03	Love Grünewald	3 x 10 mm	150 mm
31-066-03	Love Grünewald	3 x 10 mm	180 mm
31-046-04	Spurling	4 x 10 mm	120 mm
31-050-04	Spurling	4 x 10 mm	150 mm
31-066-04	Spurling	4 x 10 mm	180 mm
31-047-02	Cushing	2 x 10 mm	120 mm
31-051-02	Cushing	2 x 10 mm	150 mm
31-067-02	Cushing	2 x 10 mm	180 mm
31-047-03	Love Grünewald	3 x 10 mm	120 mm
31-051-03	Love Grünewald	3 x 10 mm	150 mm
31-067-03	Love Grünewald	3 x 10 mm	180 mm
31-047-04	Spurling	4 x 10 mm	120 mm
31-051-04	Spurling	4 x 10 mm	150 mm
31-067-04	Spurling	4 x 10 mm	180 mm

31-049-02	Cushing	2 x 10 mm	120 mm
31-053-02	Cushing	2 x 10 mm	150 mm
31-069-02	Cushing	2 x 10 mm	180 mm
31-049-03	Love Grünewald	3 x 10 mm	120 mm
31-053-03	Love Grünewald	3 x 10 mm	150 mm
31-069-03	Love Grünewald	3 x 10 mm	180 mm
31-049-04	Spurling	4 x 10 mm	120 mm
31-053-04	Spurling	4 x 10 mm	150 mm
31-069-04	Spurling	4 x 10 mm	180 mm

Instrumente auch erhältlich in zerlegbarer Ausführung und/oder mit blendfreier schwarzen Beschichtung.
Instruments also available as a detachable design, and/or with a non-reflecting coating.

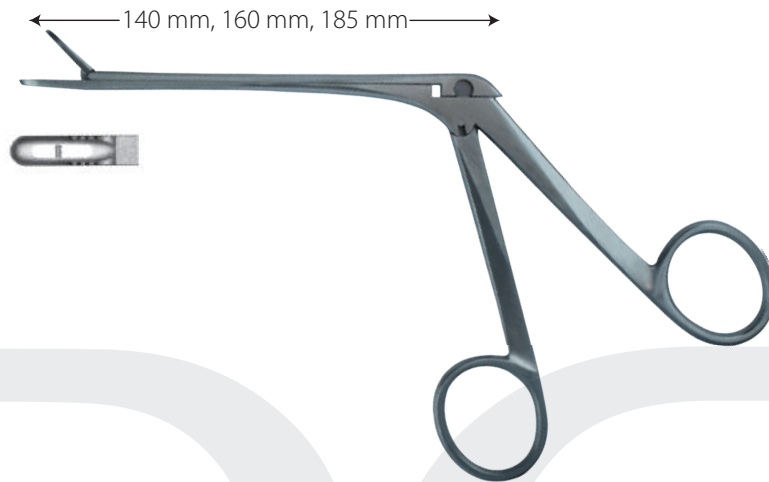

Art.-Nr. item-no.	Bezeichnung description	Maulgröße size of jaws	Schaftlänge length of shaft
31-054-02	Caspar	2 x 12 mm	140 mm
31-056-02	Caspar	2 x 12 mm	160 mm
31-058-02	Caspar	2 x 12 mm	185 mm
31-054-03	Caspar	3 x 13 mm	140 mm
31-056-03	Caspar	3 x 13 mm	160 mm
31-058-03	Caspar	3 x 13 mm	185 mm
31-054-04	Caspar	4 x 14 mm	140 mm
31-056-04	Caspar	4 x 14 mm	160 mm
31-058-04	Caspar	4 x 14 mm	185 mm
31-054-05	Caspar	5 x 14 mm	140 mm
31-056-05	Caspar	5 x 14 mm	160 mm
31-058-05	Caspar	5 x 14 mm	185 mm
31-054-06	Caspar	6 x 16 mm	140 mm
31-056-06	Caspar	6 x 16 mm	160 mm
31-058-06	Caspar	6 x 16 mm	185 mm



31-055-03	Caspar	3 x 13 mm	140 mm
31-057-03	Caspar	3 x 13 mm	160 mm
31-059-03	Caspar	3 x 13 mm	185 mm
31-055-04	Caspar	4 x 14 mm	140 mm
31-057-04	Caspar	4 x 14 mm	160 mm
31-059-04	Caspar	4 x 14 mm	185 mm
31-055-05	Caspar	5 x 14 mm	140 mm
31-057-05	Caspar	5 x 14 mm	160 mm
31-059-05	Caspar	5 x 14 mm	185 mm



31-061-03	Caspar	3 x 13 mm	140 mm
31-063-03	Caspar	3 x 13 mm	160 mm
31-065-03	Caspar	3 x 13 mm	185 mm
31-061-04	Caspar	4 x 14 mm	140 mm
31-063-04	Caspar	4 x 14 mm	160 mm
31-065-04	Caspar	4 x 14 mm	185 mm



← 180 mm, 190 mm, 200 mm →



Oldberg
18,0 cm Ø 7,0 mm **31-072-07**



Landolt
20,0 cm Ø 9,0 mm **31-074-09**



Yasargil
19,0 cm Ø 2,2 mm **31-076-22**



Yasargil
19,0 cm Ø 3,5 mm **31-076-35**

← 120 mm →

1,0 mm



31-078-10

1,5 mm



31-078-15

Struycken, 12,0 cm

31-083-02

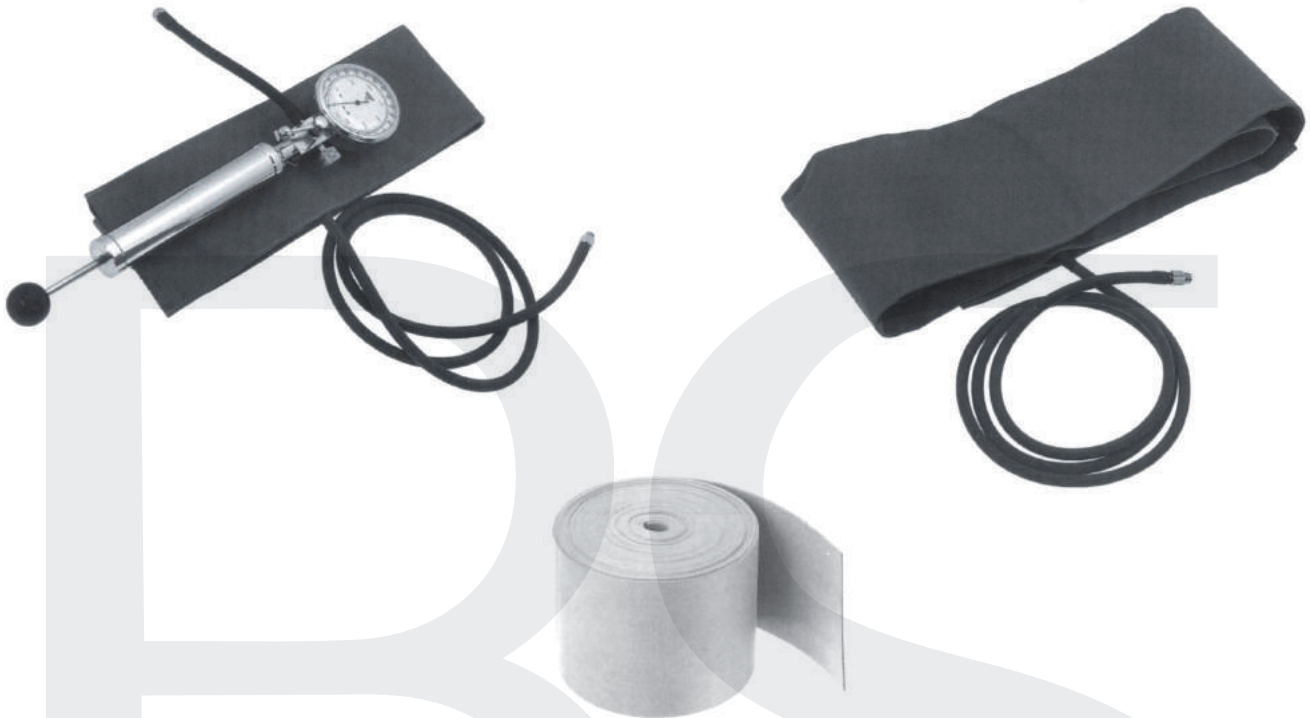

31-110-00 Komprimeter zur Erzeugung einer Blutleere in den Gliedmaßen komplett bestehend aus:

Manometer mit Membrane, Skala bis 700 mmHg,
Stabile Pumpe,
je 1 Oberarm- und Oberschenkelmanschette

31-110-00 High precision instrument for causing lack of blood in the limbs. complete consisting of:

Manometer with diaphragm, scale graduated to 700 mmHg,
Resistant pump.
1 each upper arm and upper thigh cuff

31-110-02 Luftpumpe mit Manometer

Pump with manometer

31-110-03 Oberschenkel-Manschette 120x13cm

Cuff for the leg

31-110-04 Unterarm-Manschette

Cuff for the lower arm

31-110-10 Esmarch Staubinde 5 m

Compression bandage, 5 m

31-110-14 Oberarm-Manschette 80x10cm

Cuff for the upper arm

31-110-23 Oberschenkel-Manschette 120x13cm

Cuff for the upper leg

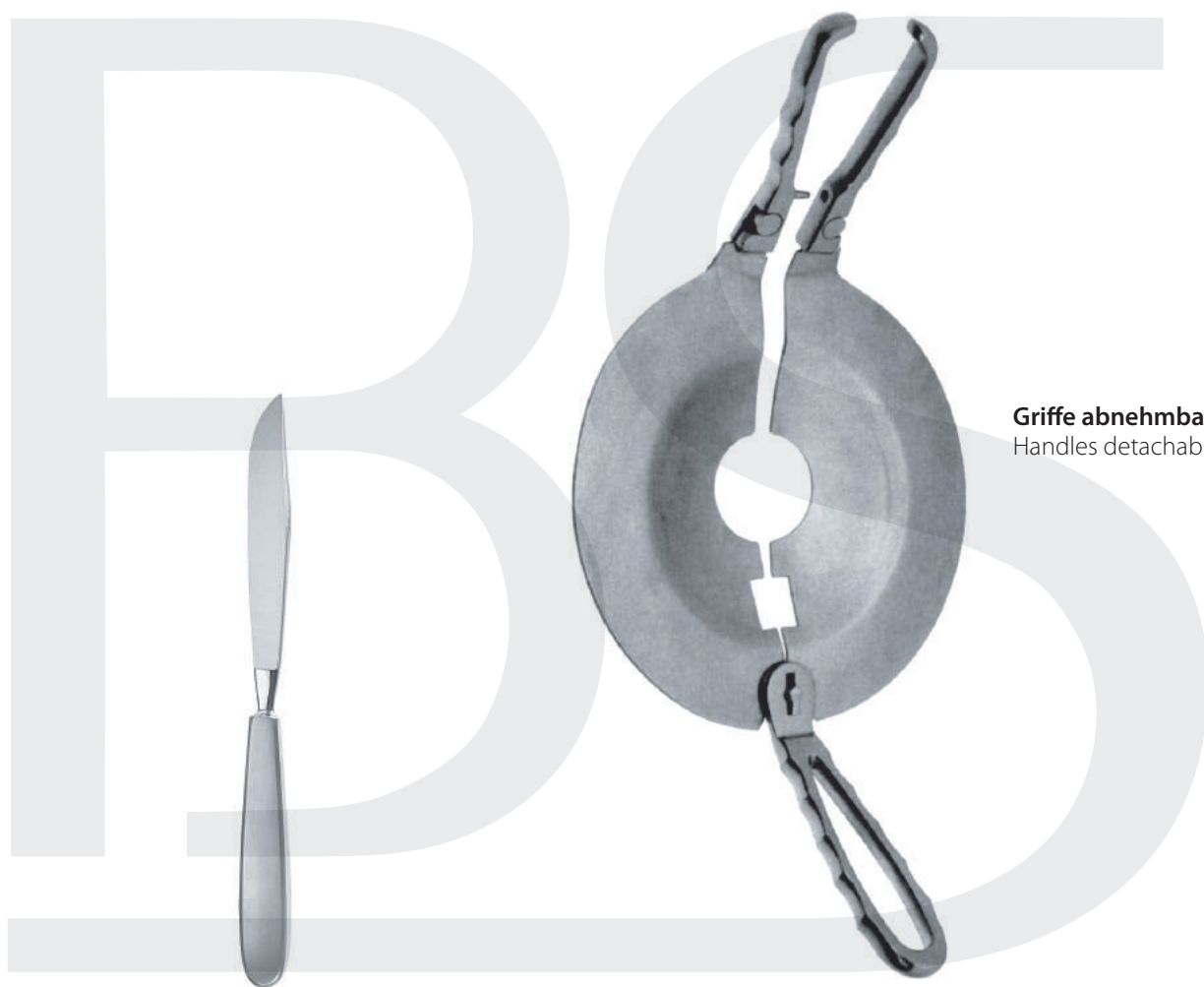

Griffe abnehmbar
Handles detachable

Langenbeck
31-114-55

Percy
31-117-01

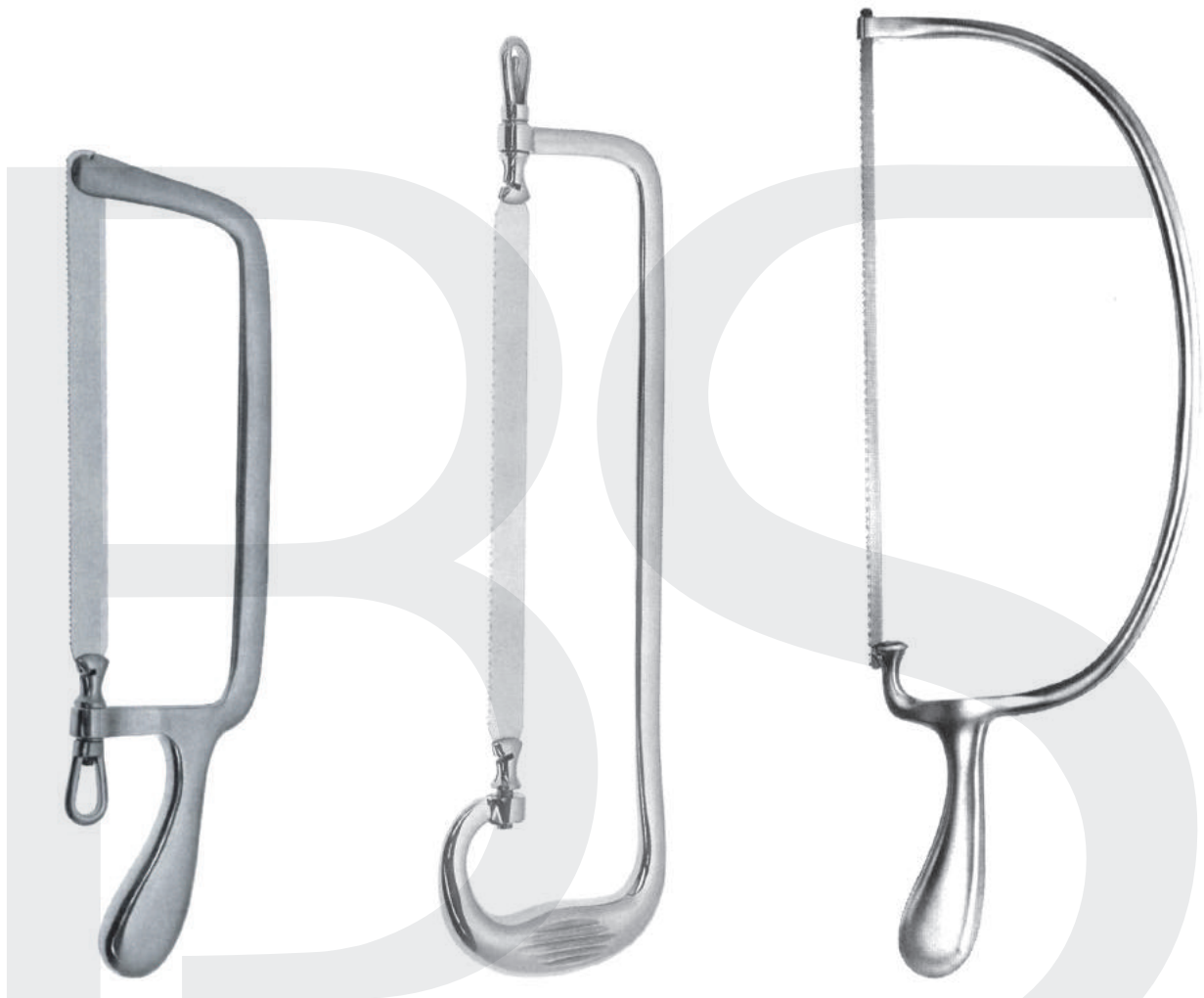

Charrière

35,0 cm **31-120-00**

Set aus 2 Blätter
set out of 2 blades

Ersatzsägeblätter/
Spare saw blades

12,0 mm **31-120-12**

15,0 mm **31-120-15**

18,0 mm **31-120-18**

Rust

39,0 cm **31-121-00**

Ersatzsägeblätter/
Spare saw blades

6,0 mm **31-121-06**

8,0 mm **31-121-08**

15,0 mm **31-121-15**

20,0 mm **31-121-20**

Helferich-Bier

42,0 cm **31-122-00**

Ersatzsägeblätter/
Spare saw blades

4,0 mm **31-122-04**

6,0 mm **31-122-06**

8,0 mm **31-122-08**



Charrière
27,0 cm **31-124-00**
Blatt 180 mm
blade 180 mm



Satterlee
29,0 cm **31-126-00**
Blatt 200 mm
blade 200 mm



Langenbeck
23,0 cm **31-128-00**
Blatt 115 mm
blade 150 mm

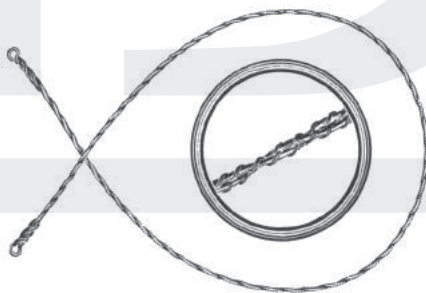

Olivecrona

2-teilig 2 wires twisted	fein, 6-teilig fine, 6 wires twisted
30,0 cm 31-130-30	31-132-30
40,0 cm 31-130-40	31-132-40
50,0 cm 31-130-50	31-132-50
60,0 cm 31-130-60	
70,0 cm 31-130-70	



Gigli
Griff für Drahtsägen
Handle for wire saws
31-135-00



Fingerringsäge
Finger Ring Saw

17,0 cm **31-137-00**



Fingerringsäge
Finger Ring Saw

17,0 cm **31-139-00**



Pfriem, vierkant
Reimer, 4-edge

14,0 cm **31-150-14**



Knochenbohrer, vierkant
Reimer, 4-edge

14,0 cm **31-152-14**

Sägeblatt (nur für gold/silber Ringe)
Saw Blade (only for gold/silver rings)

31-137-01

Sägeblatt (nur für gold/silber Ringe)
Saw Blade (only for gold/silver rings)

31-139-01



Perthes
Pfriem/Reamer
18,0 cm **31-154-18**



Perthes
Pfriem/Reamer
21,0 cm **31-156-21**



Mead
19,0 cm, Ø 20 mm, 185 g
31-200-20
Ersatzbackenpaar
Spare jaws, pair
31-200-22



18,5 cm, Ø 25 mm, 140 g
31-201-25
Ersatzbackenpaar
Spare jaws, pair
31-201-27



Cottle
19,0 cm, Ø 30 mm, 240 g
31-202-30

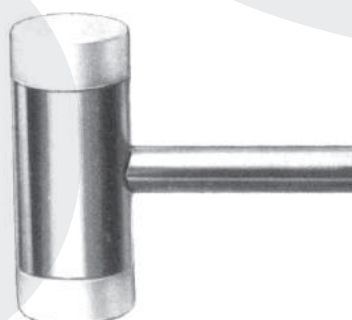

24,5 cm, Ø 30 mm, 215 g
31-206-30
Paar
Pair
31-206-32



Ferrozell
25,0 cm, Ø 35 mm **31-210-35**
25,0 cm, Ø 42 mm **31-210-42**
25,0 cm, Ø 50 mm **31-210-50**
mit Bleifüllung/lead filled
25,0 cm, Ø 42 mm, 400 g
31-224-42



26,0 cm, Ø 28/42 mm, 530 g
31-228-42



Heath
18,5 cm, Ø 40 mm, 700 g
31-214-40

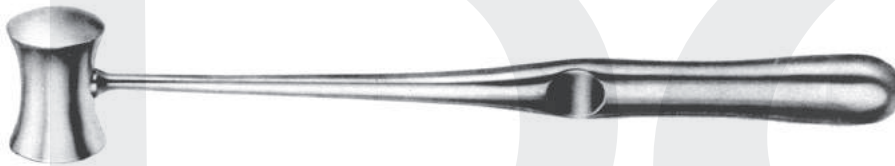

Williger
24,0 cm, Ø 30 mm, 400 g **31-215-30**



DOYEN
21,0 cm, Ø 25 mm, 120 g **31-216-25**
21,0 cm, Ø 30 mm, 180 g **31-216-30**
21,0 cm, Ø 35 mm, 260 g **31-216-35**



Collin
20,0 cm, Ø 30 mm, 220 g
31-217-30



Lucae
mit Bleifüllung/lead filled
19,0 cm, Ø 19 mm, 230 g **31-218-19**
25,0 cm, Ø 25 mm, 260 g **31-218-25**



mit Bleifüllung/lead filled
16,5 cm, Ø 22 mm, 140 g
31-219-20

Hämmer
Mallets

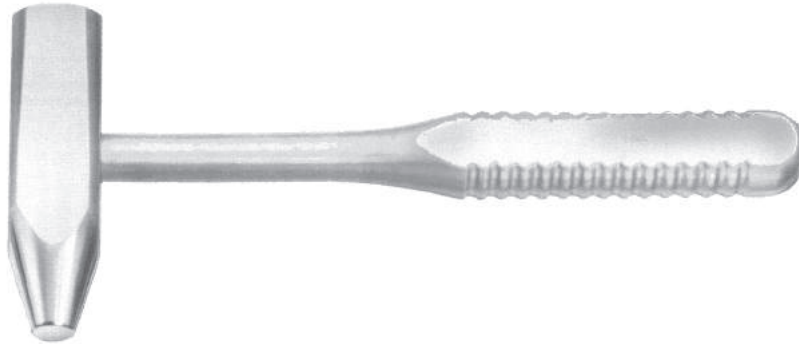

23,5 cm, 27 mm/Ø 13,5 mm
31-220-27

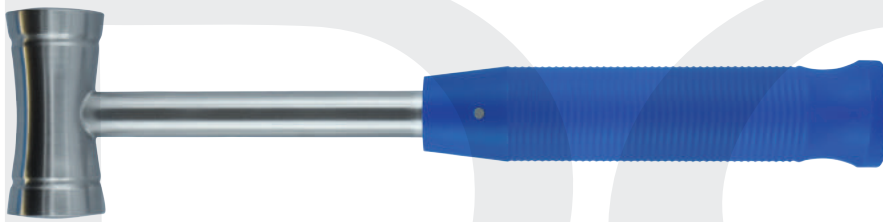

26,0 cm, Ø 30 mm, 510 g
31-221-30



Partsch
18,0 cm, Ø 22 mm
31-222-22



Ferrozell mit Bleifüllung/lead filled
26,0 cm, Ø 42 mm, 400 g
31-226-42



Ferrozell
18,0 cm, Ø 30 mm, 125 g
31-227-30

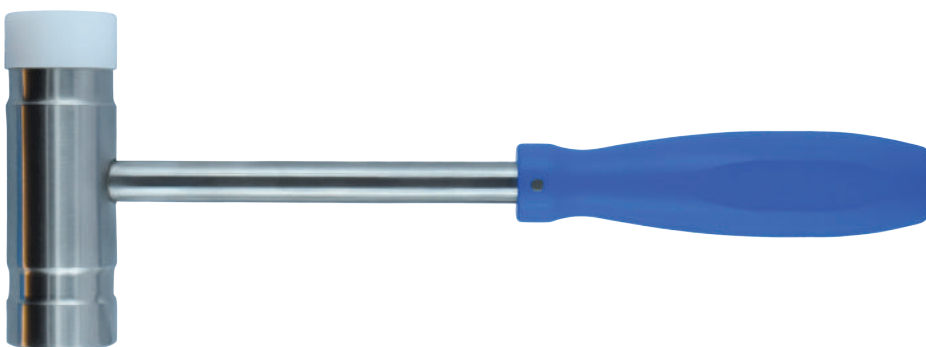

26,0 cm, Ø 32 mm, 675 g
rückschlagfrei/no rebound
31-229-29

eine Seite: **Stahl konvex**
eine Seite: **Nylon plan**
one side: Steel convex
one side: Nylon plane

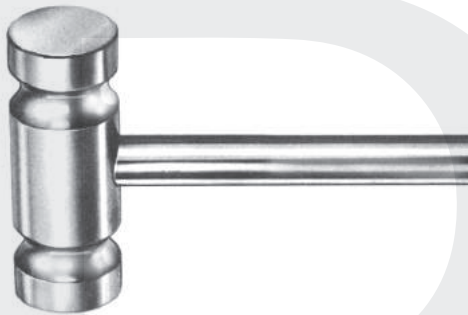

26,0 cm, Ø 30 mm, 450 g
31-230-45



26,0 cm, Ø 50 mm, 900 g
31-230-90



24,0 cm, Ø 30 mm, 480 g
31-231-48



Passow, 12,0 cm



Stößel, 15,5 cm

Ø 2 mm
31-251-02

Ø 4 mm
31-251-04

Ø 6 mm
31-251-06

Ø 10 mm
31-251-10

Ø 3 mm
31-251-02

Ø 5 mm
31-251-05

Ø 8 mm
31-251-08



Freer, 4,0 mm



16,0 cm **31-254-04**



16,0 cm **31-255-04**



Osteotom
Osteotome
14,0 cm

4 mm **31-262-04** 6 mm **31-262-06** 8 mm **31-262-08**

10 mm
31-262-10

12 mm
31-262-12

14 mm
31-262-14

16 mm
31-262-16



Flachmeißel
Chisel
14,0 cm

4 mm **31-263-04** 6 mm **31-263-06** 8 mm **31-263-08**

10 mm
31-263-10

12 mm
31-263-12

14 mm
31-263-14

16 mm
31-263-16

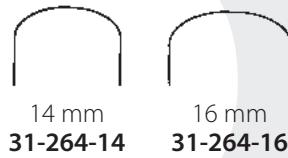
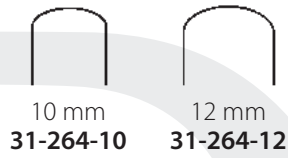

Hohlmeißel
Gouge
14,0 cm

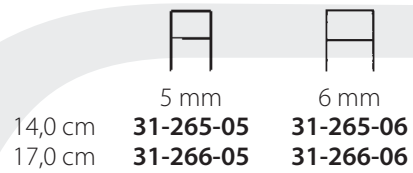
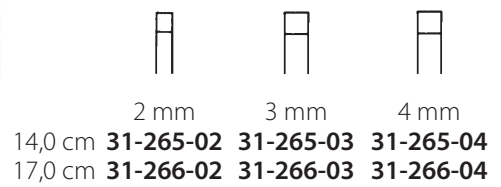

Partsch
Flachmeißel/Chisel

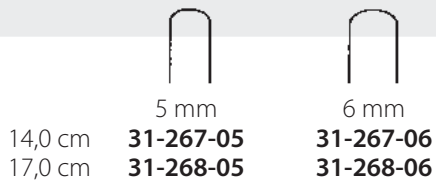
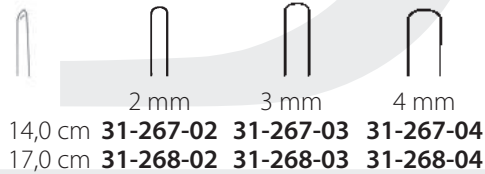

Partsch
Hohlmeißel/Gouge

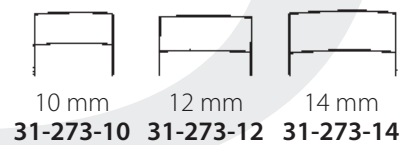

Alexander
Flachmeißel/Chisel
18,0 cm

Product	Width (mm)	Length (cm)	Part Number
Alexander Hohlmeißel/Gouge	4 mm	18,0	31-274-04
	6 mm	18,0	31-274-06
	8 mm	18,0	31-274-08
	10 mm	18,0	31-274-10
	14 mm	18,0	31-274-14
Mini-Lambotte Osteotom/Osteotome	2 mm	12,5	31-276-02
	3 mm	12,5	31-276-03
	4 mm	12,5	31-276-04
	-	17,0	31-277-03
	-	17,0	31-277-04
	6 mm	12,5	31-276-06
	8 mm	12,5	31-276-08
	10 mm	12,5	31-276-10
	6 mm	17,0	31-277-06
	8 mm	17,0	31-277-08
	10 mm	17,0	31-277-10
	12 mm	12,5	31-276-12
15 mm	12,5	31-276-15	
12 mm	17,0	31-277-12	
15 mm	17,0	31-277-15	

Alexander Hohlmeißel/Gouge
18,0 cm

Mini-Lambotte Osteotom/Osteotome

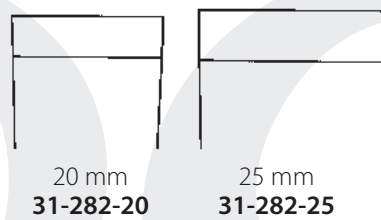
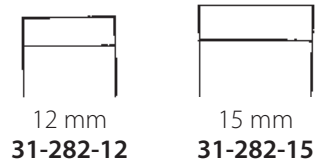
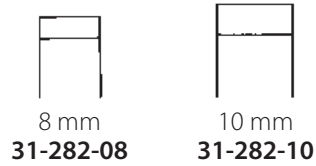

Stille
Flachmeißel/Chisel
20,0 cm



Stille
Osteotom/Osteotome
31-284-08 - 31-286-25
20,0 cm



gerade/straight
gebogen/curved
fein/small

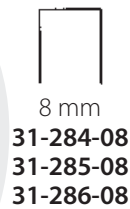

gerade/straight
gebogen/curved
fein/small



gerade/straight
gebogen/curved
fein/small

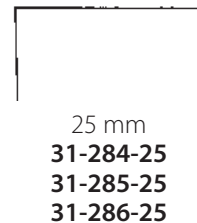
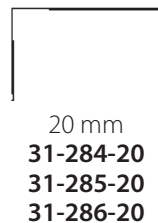

Meißel, Osteotome
Bone Chisels and Gouges



31-288-10



31-289-10

31-288-12



31-289-12

31-288-15



31-289-15

31-288-20

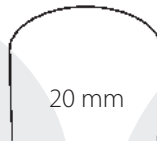

31-289-20

31-288-25

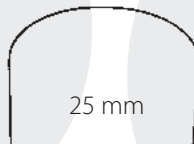

31-289-25

Stille
Hohlmeißel/Gouge
20,0 cm

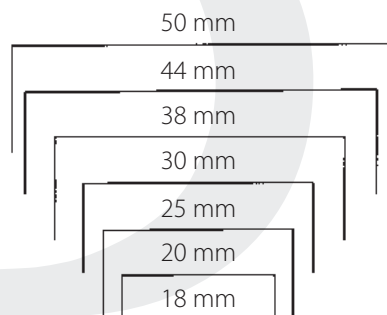

- 4,0 mm 31-292-04
- 5,0 mm 31-292-05
- 6,0 mm 31-292-06
- 8,0 mm 31-292-08
- 10,0 mm 31-292-10
- 13,0 mm 31-292-13
- 15,0 mm 31-292-15
- 18,0 mm 31-292-18
- 20,0 mm 31-292-20
- 25,0 mm 31-292-25
- 30,0 mm 31-292-30
- 38,0 mm 31-292-38
- 44,0 mm 31-292-44
- 50,0 mm 31-292-50

- 4,0 mm 31-293-04
- 5,0 mm 31-293-05
- 6,0 mm 31-293-06
- 8,0 mm 31-293-08
- 10,0 mm 31-293-10
- 13,0 mm 31-293-13
- 15,0 mm 31-293-15
- 18,0 mm 31-293-18
- 20,0 mm 31-293-20
- 25,0 mm 31-293-25
- 30,0 mm 31-293-30
- 38,0 mm 31-293-38
- 44,0 mm 31-293-44
- 50,0 mm 31-293-50



Lambotte
Osteotom/Osteotome
24,0 cm









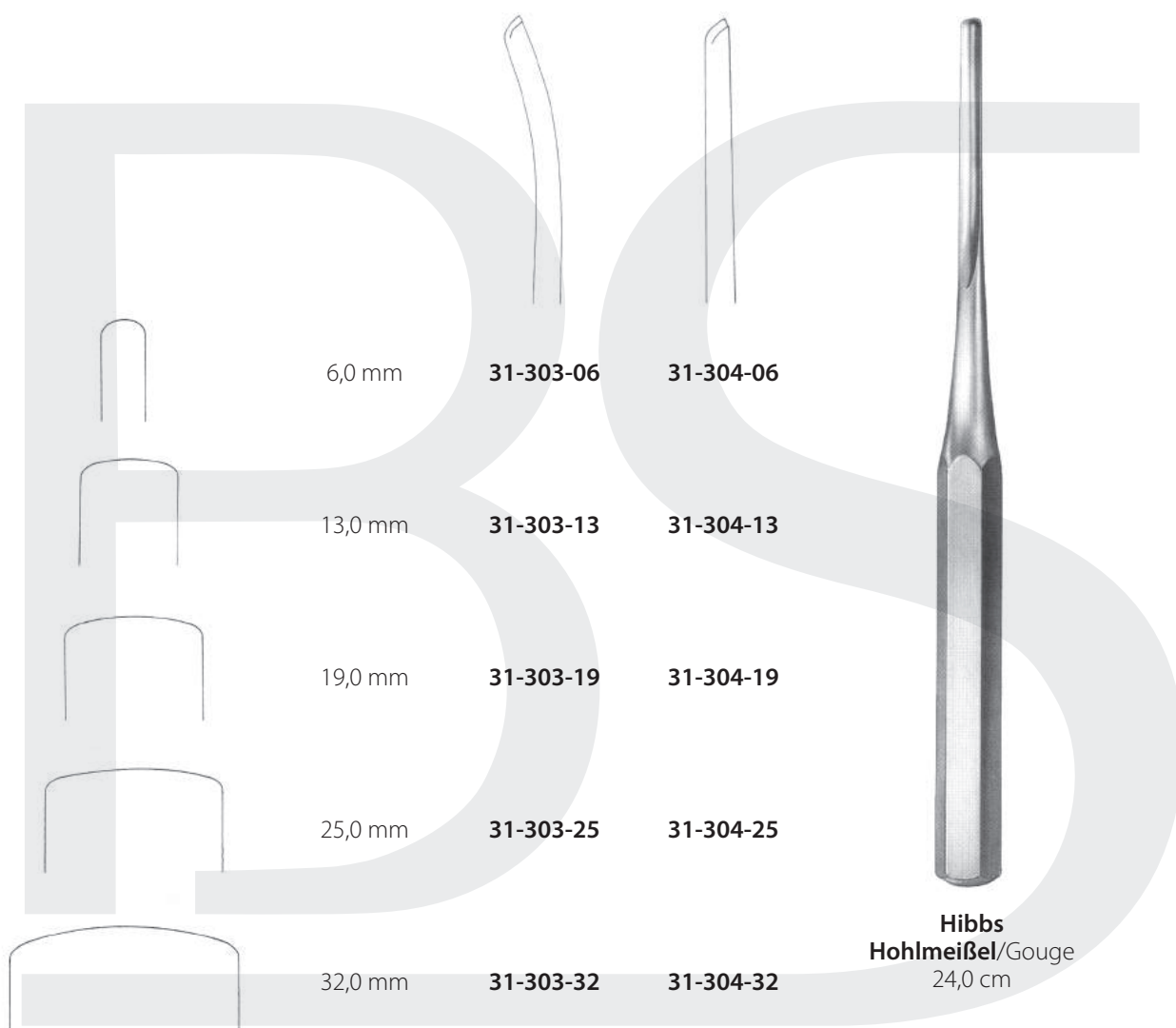





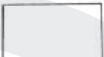

Hoke Flachmeißel/Chisel
17,0 cm

	3,0 mm 31-298-03		5,0 mm 31-298-05
	6,0 mm 31-298-06		8,0 mm 31-298-08
	9,0 mm 31-298-09		

	Osteotom	Flachmeißel	
	31-300-06	31-301-06	31-302-06
	31-300-13	31-301-13	31-302-13
	31-300-19	31-301-19	31-302-19
	31-300-25	31-301-25	31-302-25
	31-300-32	31-301-32	31-302-32

Hibbs Flachmeißel/Chisel
24,0 cm



 <p>Smith-Petersen, 20,0 cm</p>		6,0 mm		31-306-06		31-307-06
		9,0 mm	31-306-09	31-307-09		
		13,0 mm	31-306-13	31-307-13		
		16,0 mm	31-306-16	31-307-16		
		19,0 mm	31-306-19	31-307-19		
		25,0 mm	31-306-25	31-307-25		
		32,0 mm	31-306-32	31-307-32		
		6,0 mm	31-308-06	31-309-06		
		9,0 mm	31-308-09	31-309-09		
		13,0 mm	31-308-13	31-309-13		
		16,0 mm	31-308-16	31-309-16		
		19,0 mm	31-308-19	31-309-19		
		25,0 mm	31-308-25	31-309-25		
		32,0 mm	31-308-32	31-309-32		



Smith-Petersen, 20,0 cm



Meißelgriff mit Schlüssel
Handle for blades, with key
31-310-00

Ersatzschraube
Spare screw
31-310-99

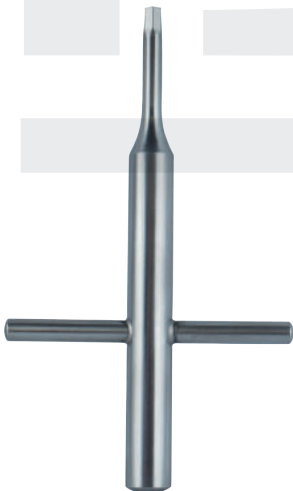

Spannschlüssel
Key
31-310-80

Wechselklingen
Interchangeable blades

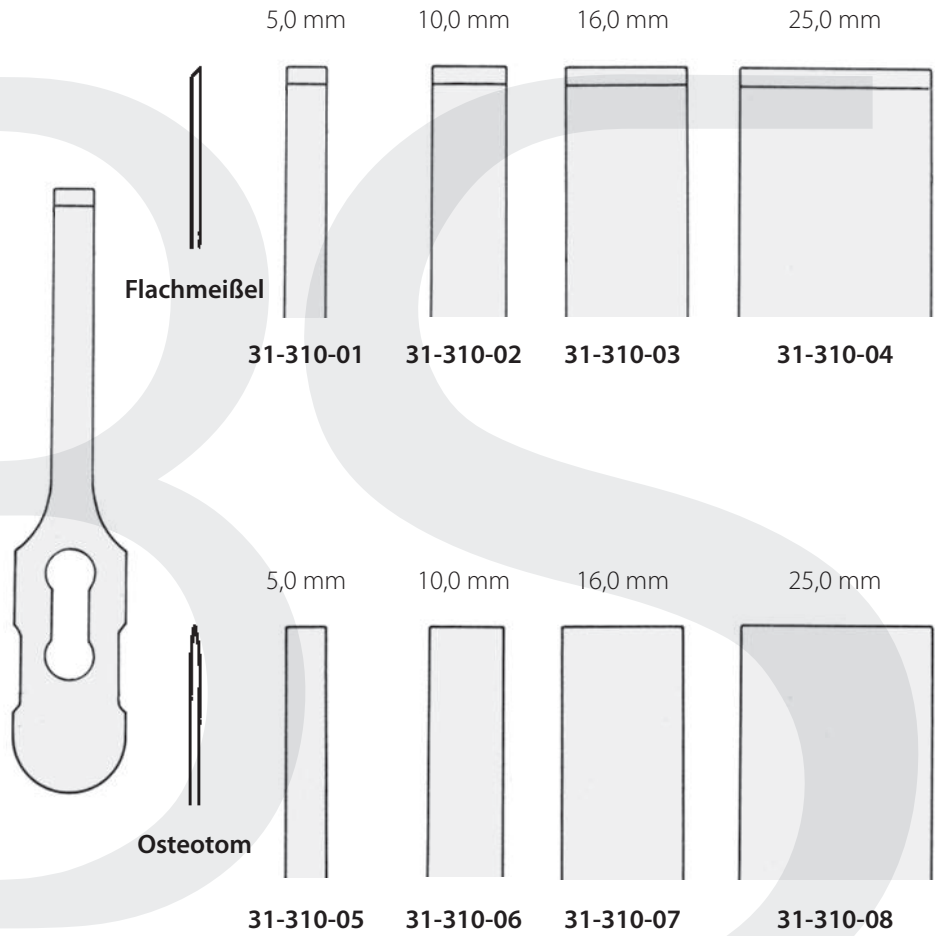



10,0 mm **31-313-10**

15,0 mm **31-313-15**

20,0 mm **31-313-20**

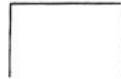

10,0 mm **31-314-10**

15,0 mm **31-314-15**

20,0 mm **31-314-20**



Osteotom, 20,0 cm

Osteotom, 20,0 cm



4,0 mm
31-316-04

6,0 mm
31-316-06

8,0 mm
31-316-08

10,0 mm
31-316-10

12,0 mm
31-316-12

Lexer-Mini, 18,0 cm



4,0 mm
31-318-04

6,0 mm
31-318-06

8,0 mm
31-318-08

10,0 mm
31-318-10

12,0 mm
31-318-12

Lexer-Mini, 18,0 cm

Meißel, Osteotome
Bone Chisels and Gouges

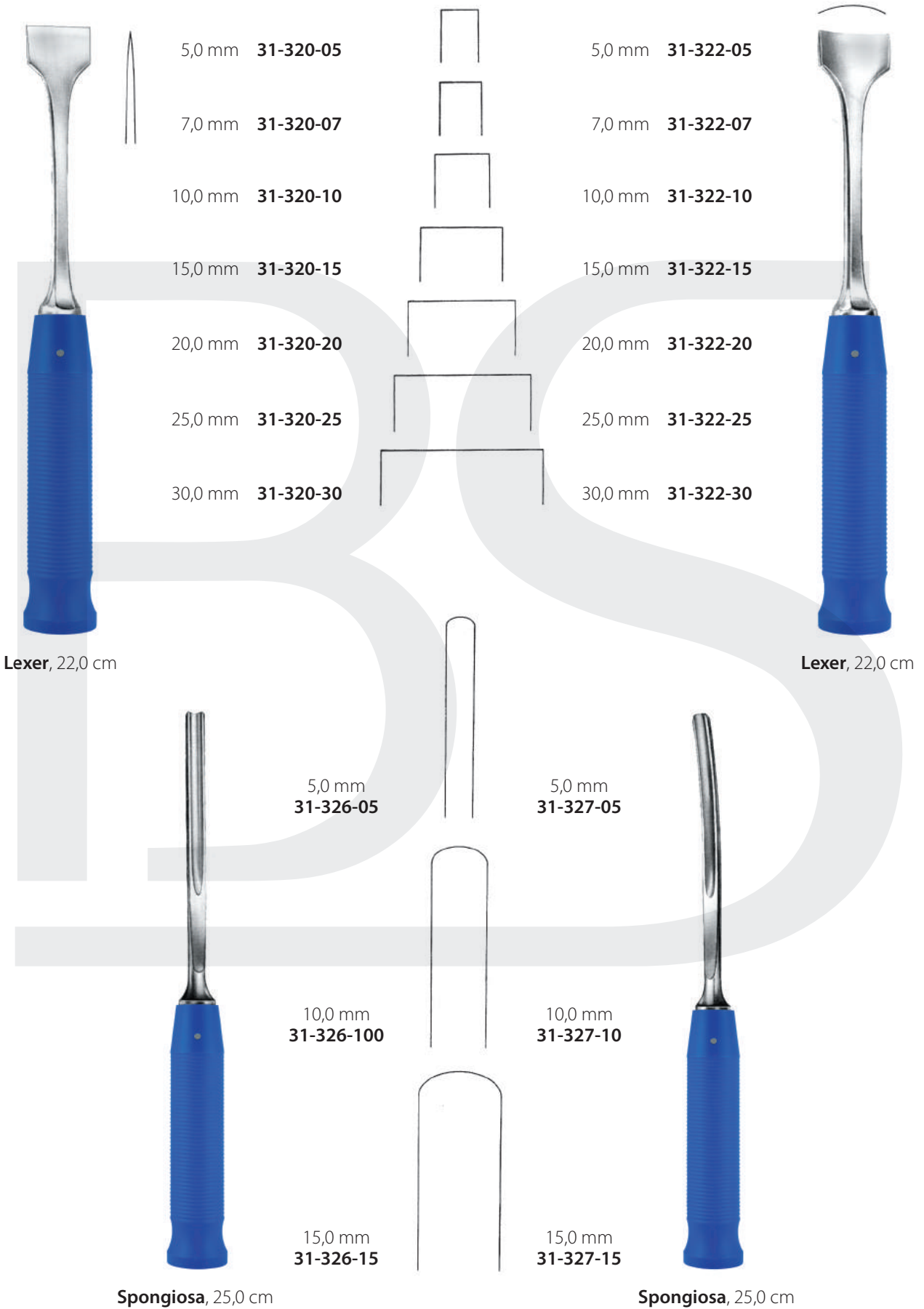



Lexer-Spongiosa, 28,0 cm



7,0 mm
31-334-07



10,0 mm
31-334-10

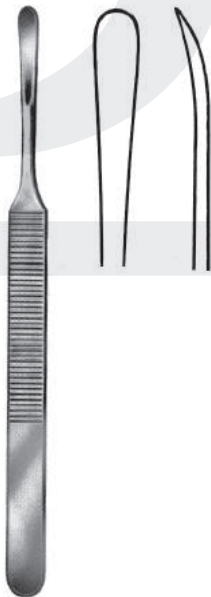

König, 5,0 mm
15,5 cm **31-353-15**

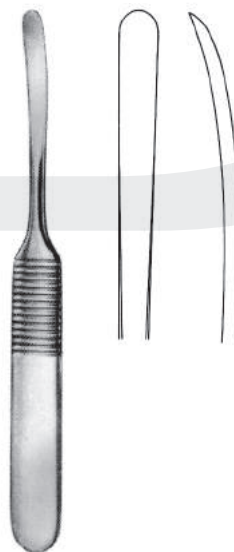

Williger, 5,0 mm
13,0 cm **31-355-14**



Williger, 6,0 mm
16,0 cm **31-355-16**

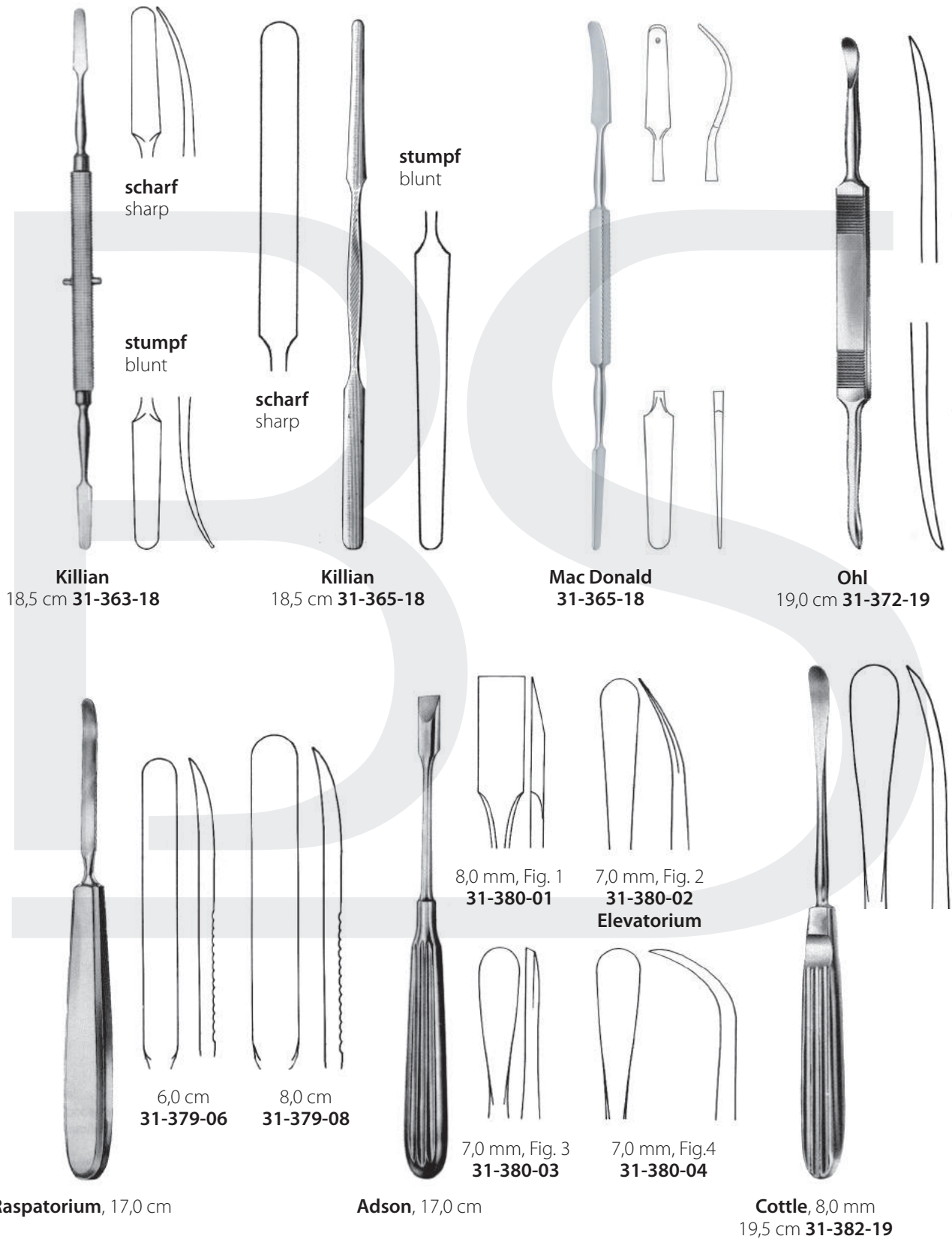

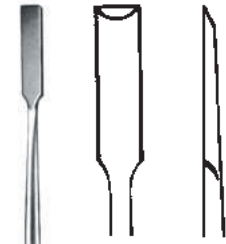

19,0 cm, 6 mm
31-390-01



18,5 cm, 3 mm
31-390-02



19,0 cm, 6 mm
31-390-03



19,0 cm, 6 mm
31-390-04

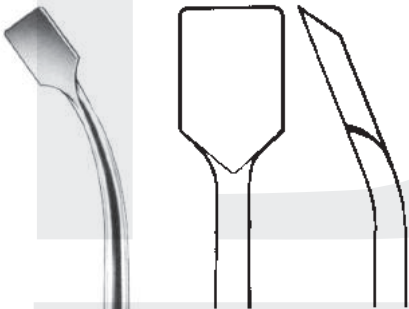

18,5 cm, 13 mm
31-391-01

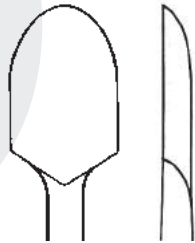

19,5 cm, 14 mm
31-391-02

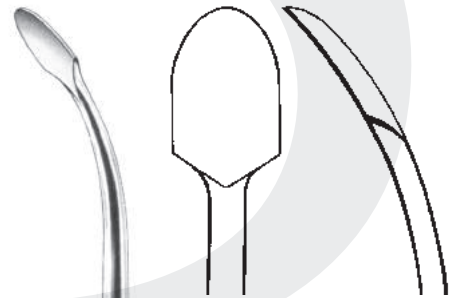

19,0 cm, 14 mm
31-391-03

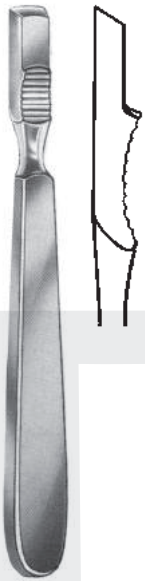

Farabeuf, 12,5 mm
15,0 cm **31-392-14**

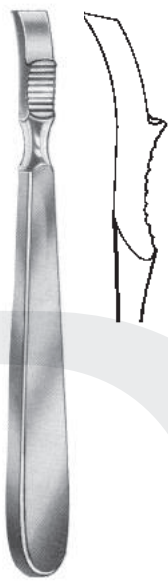

Farabeuf, 12,5 mm
15,0 cm **31-393-14**



Farabeuf-Collin, 11,0 mm

16,0 cm
31-394-16



16,0 cm
31-395-16



Langenbeck, 14 mm
16,5 cm **31-401-01**



Langenbeck, 16 mm
19,0 cm **31-401-02**

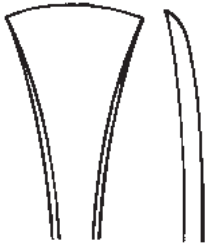

Sedillot, 14 mm
21,0 cm **31-404-21**



Lambotte, 21,5 cm
5 mm **31-405-05**
10 mm **31-405-10**
15 mm **31-405-15**
20 mm **31-405-20**
25 mm **31-405-25**



Alexander, 12 mm
21,0 cm **31-406-21**

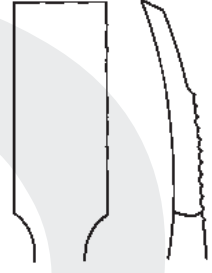



12 mm, 18 cm 31-408-01 13 mm, 18 cm 31-408-02 12 mm, 21 cm 31-408-03 13 mm, 21 cm 31-408-04 13 mm, 18 cm 31-408-05 15 mm, 21 cm 31-408-06 10 mm, 21 cm 31-408-07

Semb

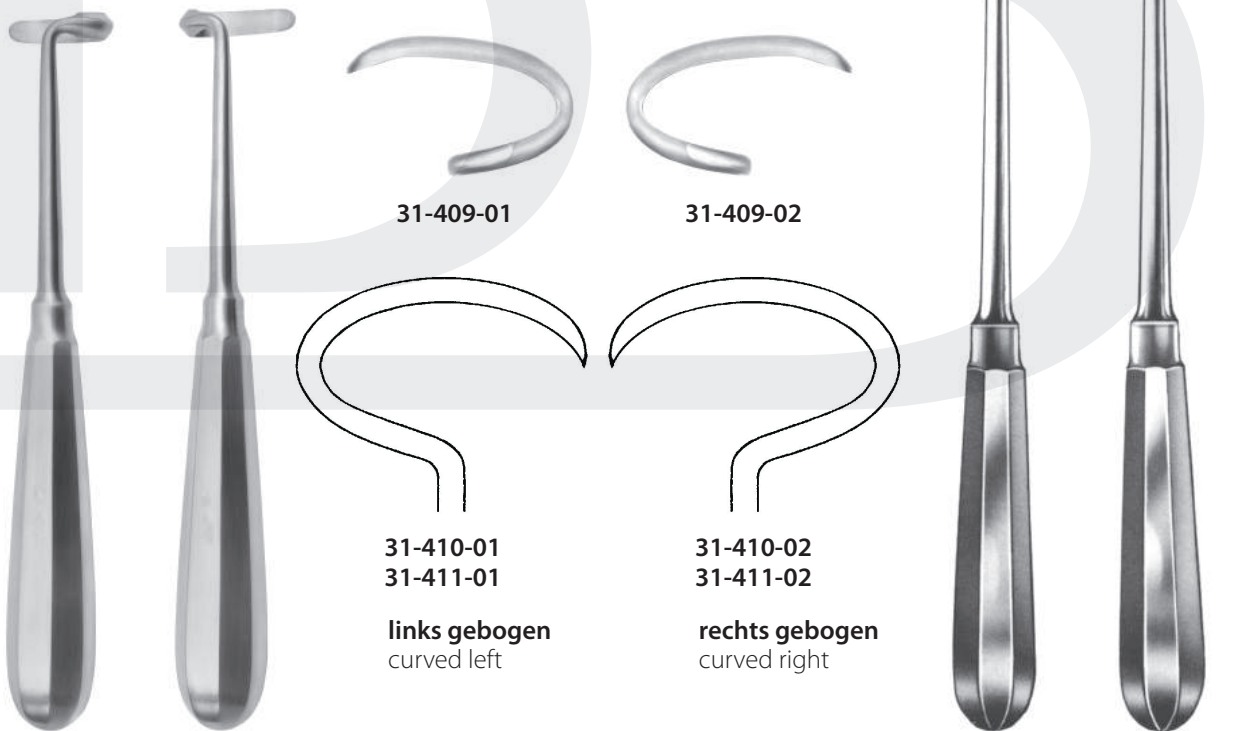

31-409-01

31-409-02

31-410-01
31-411-01

links gebogen
curved left

31-410-02
31-411-02

rechts gebogen
curved right

Doyen, 17,5 cm

31-409-01 - 31-409-02 **Kinder/children**
31-410-01 - 31-410-02 **Erwachsene/adults**

Doyen, 24,0 cm

31-411-01 - 31-411-02



16 mm, 19 cm
31-412-01

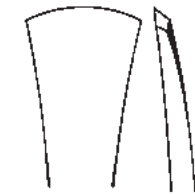

16 mm, 19 cm
31-412-02

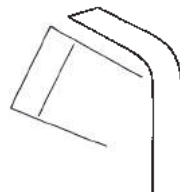

12 mm, 19 cm
31-412-03

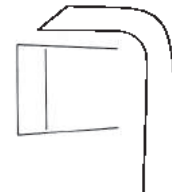

12 mm, 18 cm
31-412-04

Langenbeck



Hoer



7 mm, 16 cm
31-412-10



15 mm, 18,5 cm
31-412-11

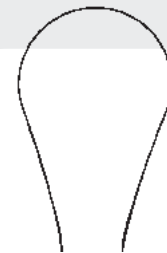

20 mm, 19 cm
31-412-23



Cushing



4 mm, 17 cm
31-412-20



6 mm, 17 cm
31-412-21



5 mm, 19,5 cm
31-412-25



7 mm, 19,5 cm
31-412-26



8 mm, 17 cm
31-412-30



Raspatorium, 16,0 cm

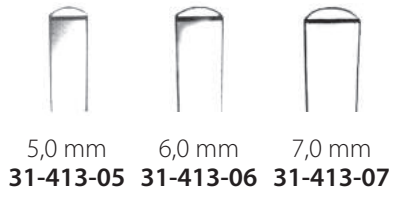

Obwegeser, 15,0 cm

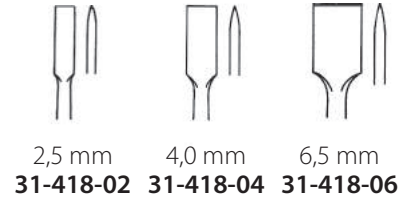

Raspatorium
27,5 cm 31-415-27 20 mm 33,0 cm 31-416-01 8 mm
33,0 cm 31-416-02 17 mm

Elevatorien/Knochenheber
Elevators/Bone Levers



König, 4,5 mm
15,5 cm **31-420-01**



König, 4,5 mm
15,5 cm **31-420-02**



5,5 mm
15,5 cm **31-421-16**



16,5 cm, 5,0 mm
31-422-01



17,0 cm, 5,5 mm
31-422-02

Williger



Sebileau, 5,0 mm
17,5 cm **31-423-01**



Quervain, 6,0 mm
20,0 cm **31-423-02**



19,5 cm, 8,0 mm
31-423-03



19,5 cm, 10,0 mm
31-423-04



Langenbeck



Langenbeck, 11,0 mm
23,0 cm **31-423-05**



17,0 cm, 5,0 mm
31-423-15



17,0 cm, 7,0 mm
31-423-17



17,0 cm, 8,0 mm
31-423-18



20,0 cm, 10,0 mm
31-423-19

Martin-Langenbeck



2,8 mm
16,0 cm **31-424-01**



15,0 cm
4,5 mm **31-424-02** 6,0 mm **31-424-03**



16,0 cm
2/6 mm **31-425-02** 2/8 mm **31-425-03**



2/15 mm
12,5 cm **31-425-04**

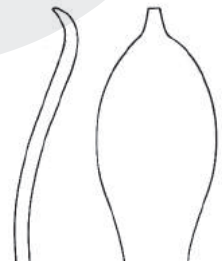

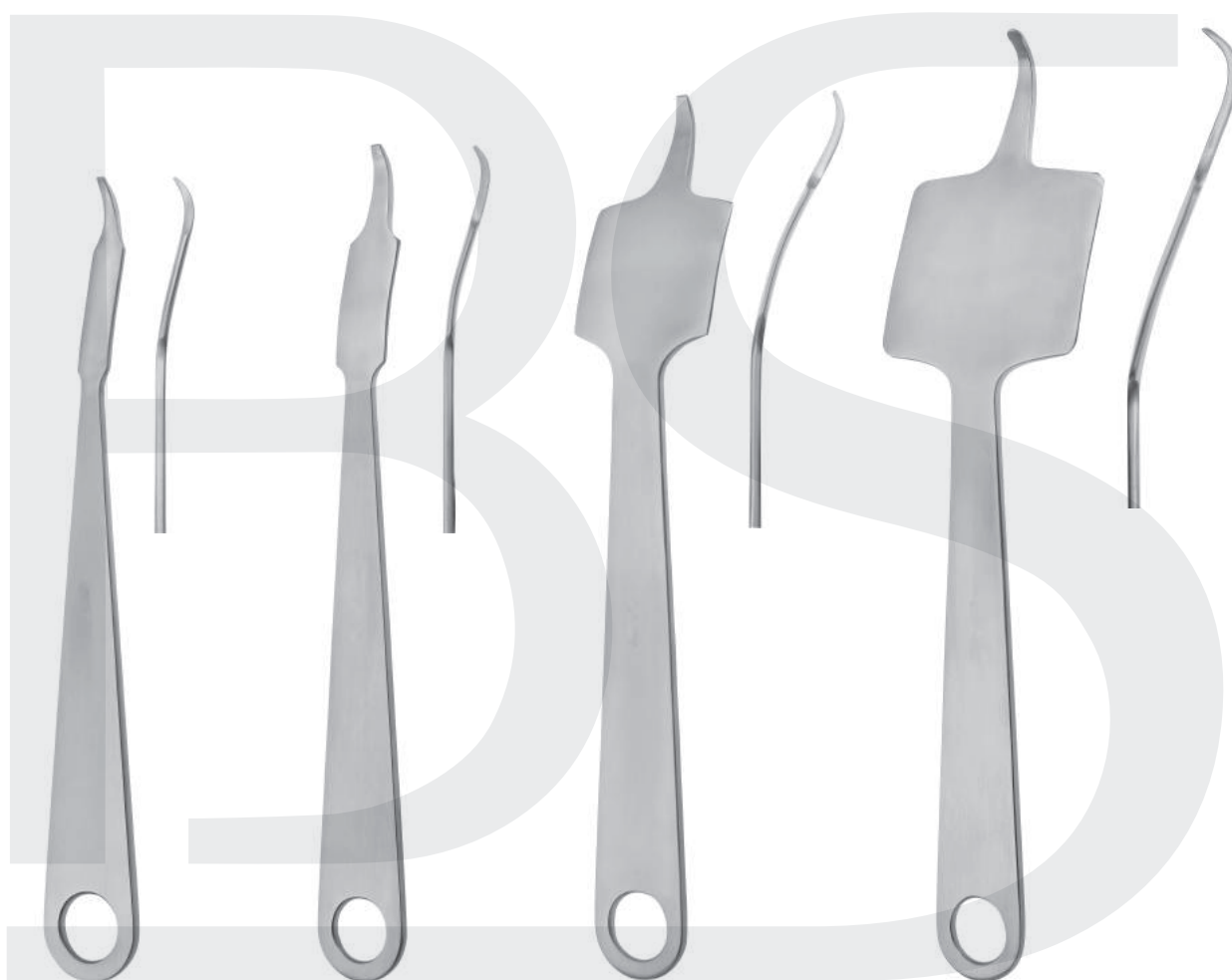

Hohmann, 10 mm
22,0 cm **31-428-01**

Hohmann, 17 mm
24,0 cm **31-428-02**

Hohmann, 44 mm
24,0 cm **31-428-03**

Hohmann, 65 mm
25,5 cm **31-428-04**

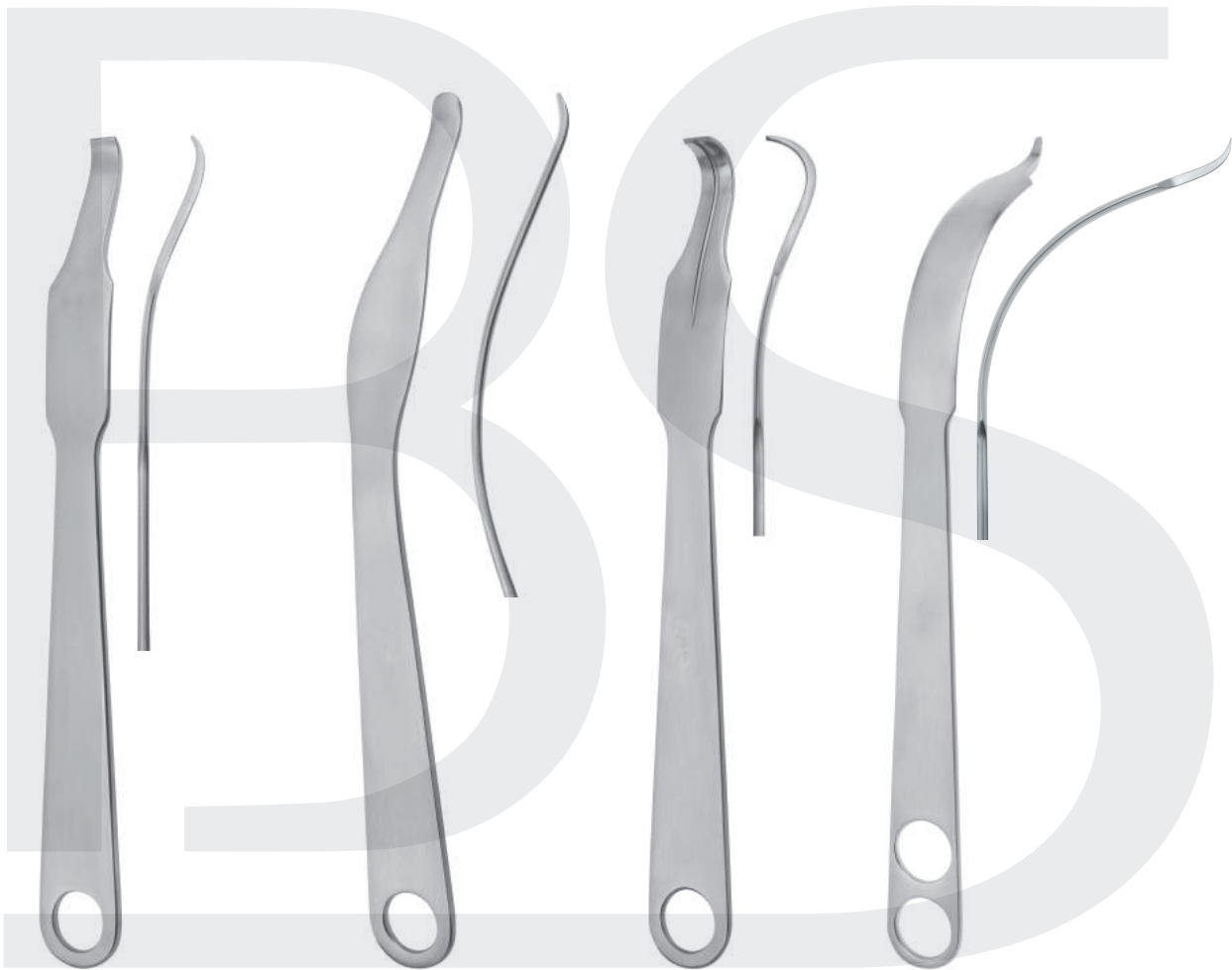

Hohmann, 24 mm
26,0 cm **31-428-06**

Hohmann, 25 mm
26,0 cm **31-428-08**

31-428-09

31-428-12

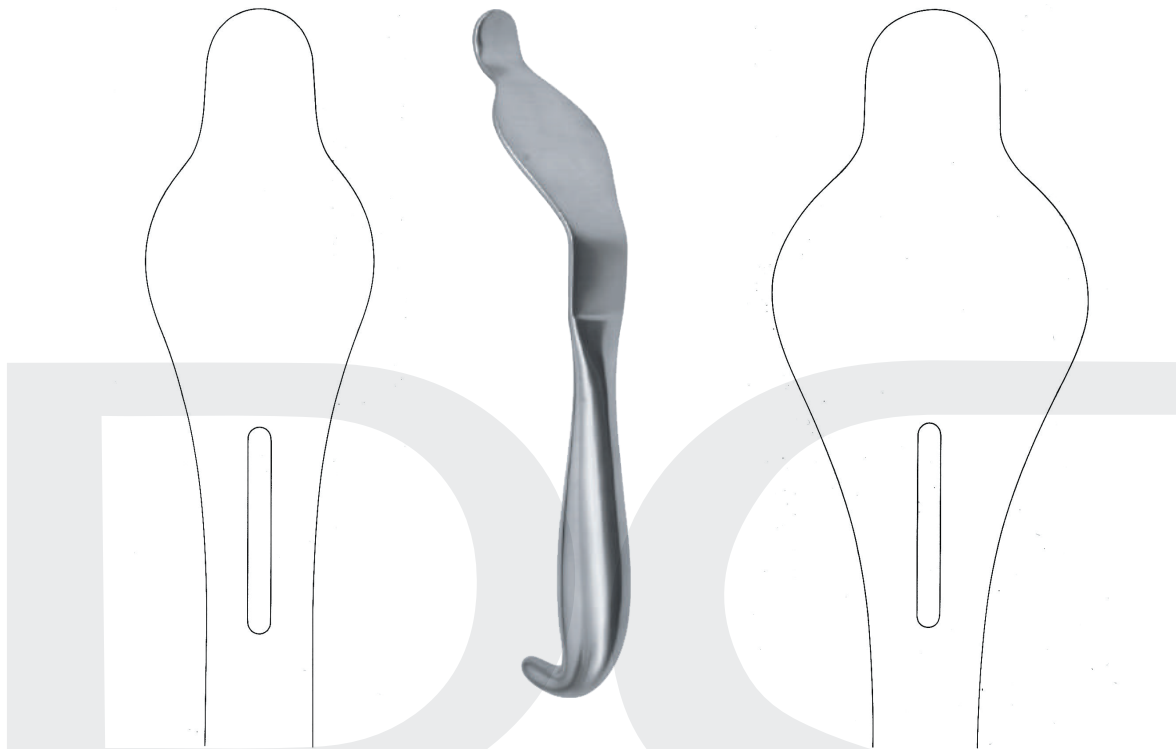

Bennet

23,5 cm 20/45 mm **31-434-23**

Bennet

23,5 cm 25/65 mm **31-434-24**

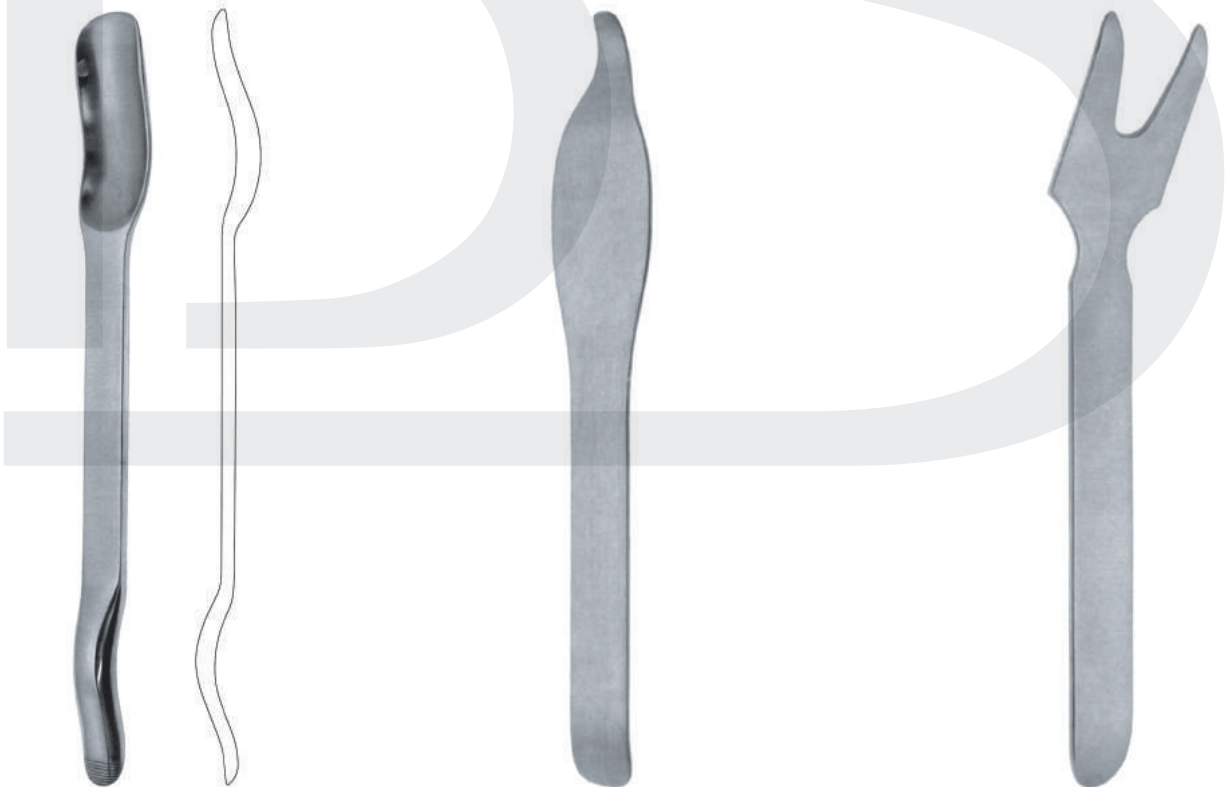

Murphy-Lane, 30,0 cm

31-435-34

Blount, 38,0 mm

26,0 cm **31-436-26**

Blount, 2-zinkig, 38,0 mm
double pronged

26,0 cm, **31-437-26**

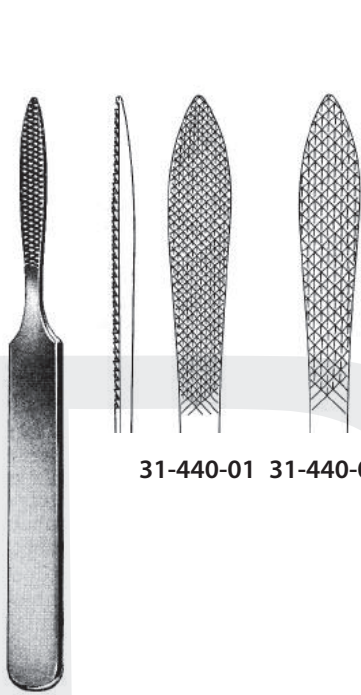

31-440-01 31-440-02

Josef, 16,5 cm



Lewis, 17,5 cm

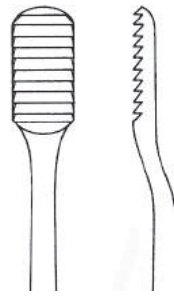

31-441-01

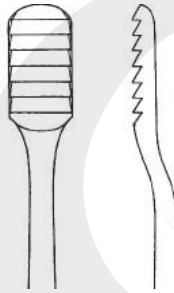

31-441-02



Maltz, 9,0 mm
17,5 cm 31-442-18

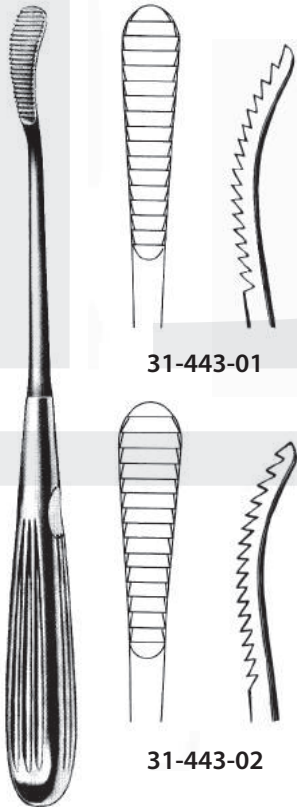

31-443-01

31-443-02

Aufricht, 22,0 cm



Fig. 1
31-444-01



Fig. 2 Fig. 3
31-444-02 31-444-03



Gallaher, 19,0 cm

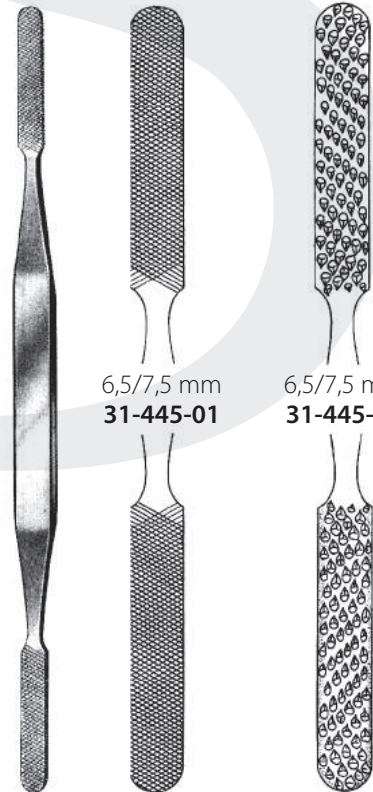

6,5/7,5 mm
31-445-01

6,5/7,5 mm
31-445-02

Fomon, 21,5 cm

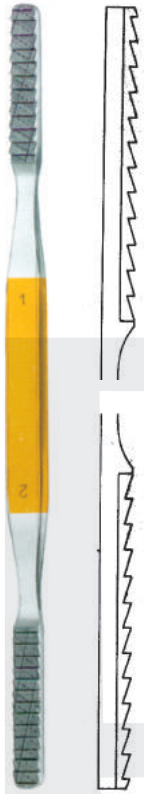

Raspel, 21,0 cm

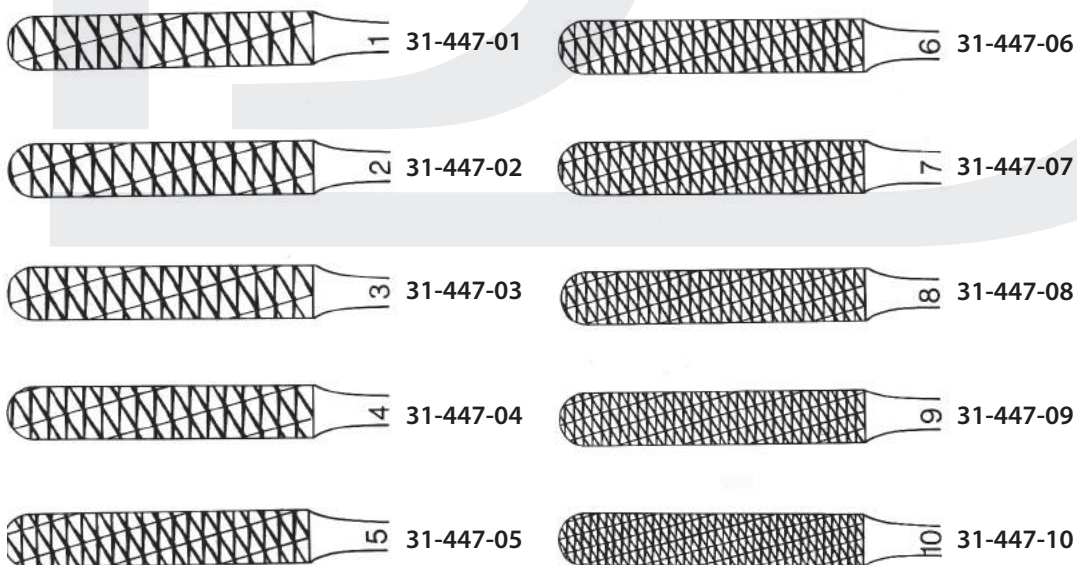
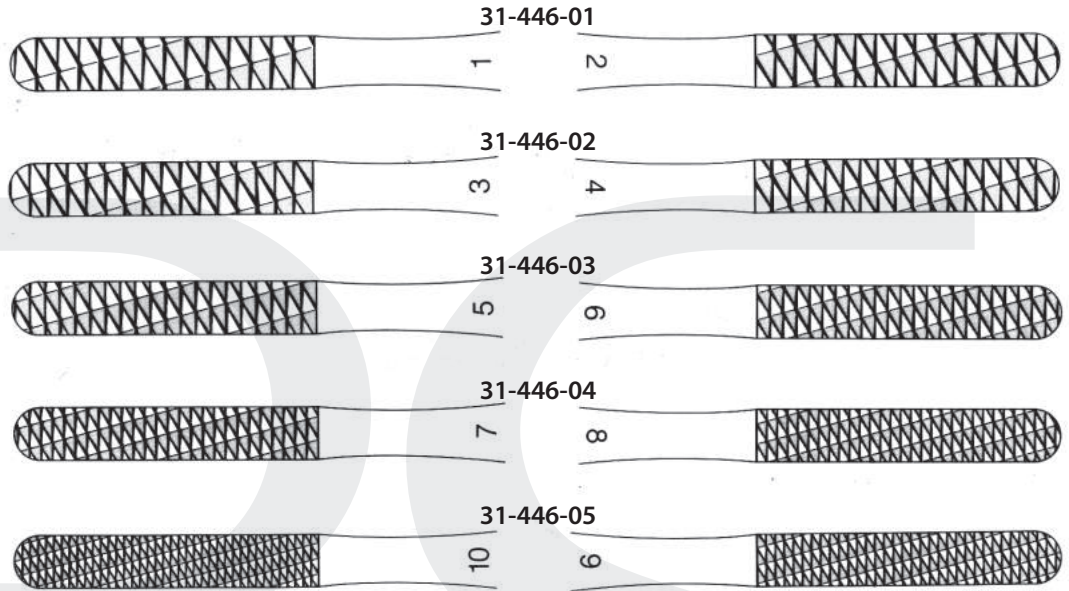

Maltz, 21,0 cm



22,0 cm, 20 mm
31-448-22

22,0 cm, 13 mm
31-449-24

28,0 cm, 20 mm
31-449-28

Putti
27,0 cm, 18/20 mm
31-451-27

Putti
30,0 cm
31-452-30



31-453-01 31-453-02

Wiener, 18,0 cm

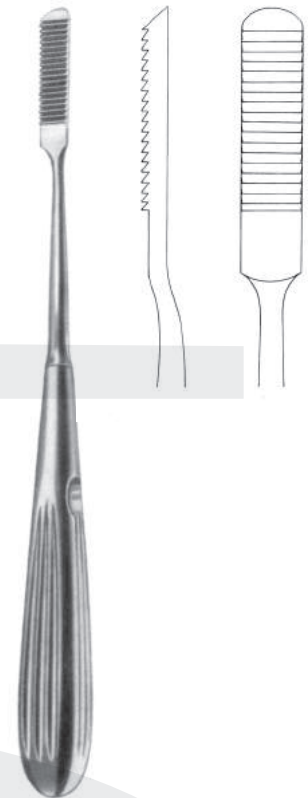

Cottle
21,0 cm 31-454-21



Miller, 19,0 cm

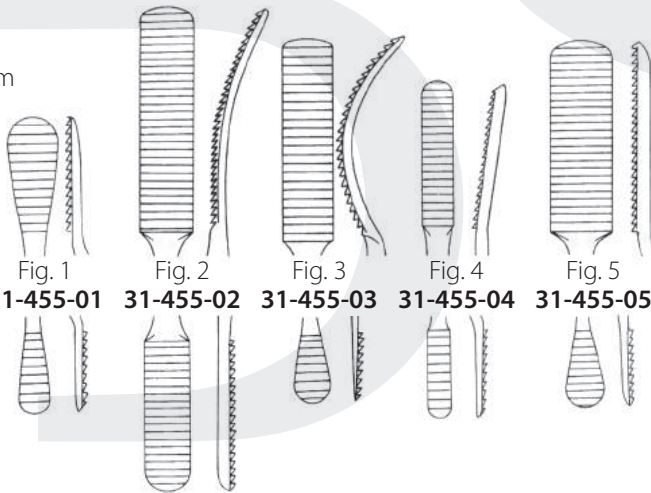

Fig. 1 31-455-01 Fig. 2 31-455-02 Fig. 3 31-455-03 Fig. 4 31-455-04 Fig. 5 31-455-05

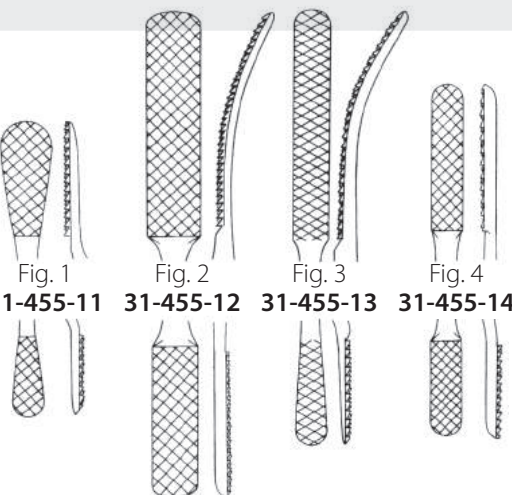
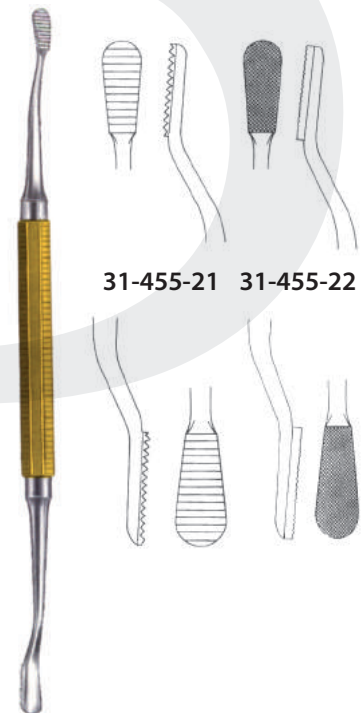
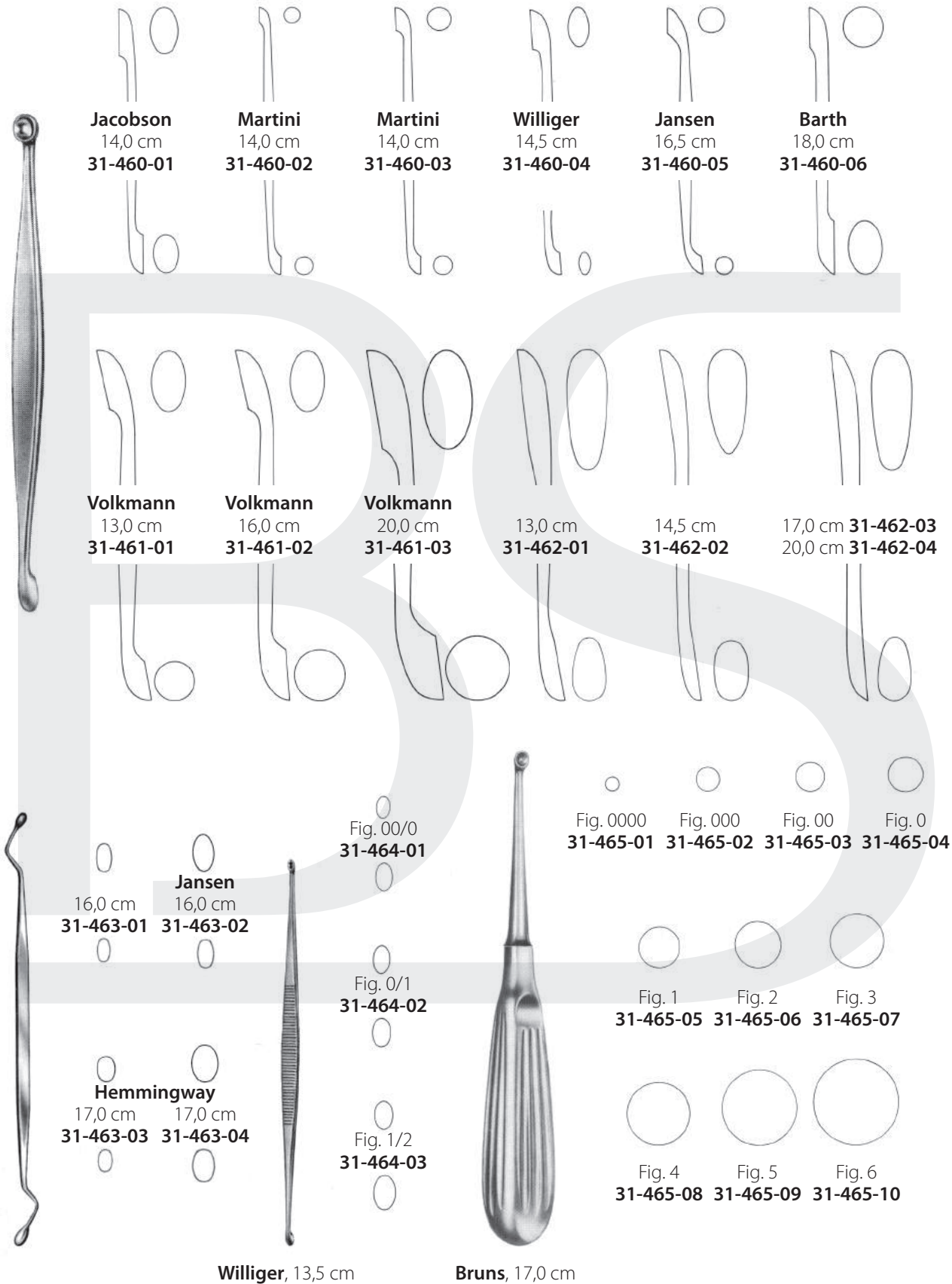

Fig. 1 31-455-11 Fig. 2 31-455-12 Fig. 3 31-455-13 Fig. 4 31-455-14



Miller, 19,0 cm

31-455-21 31-455-22



Scharfe Löffel
Bone Curettes

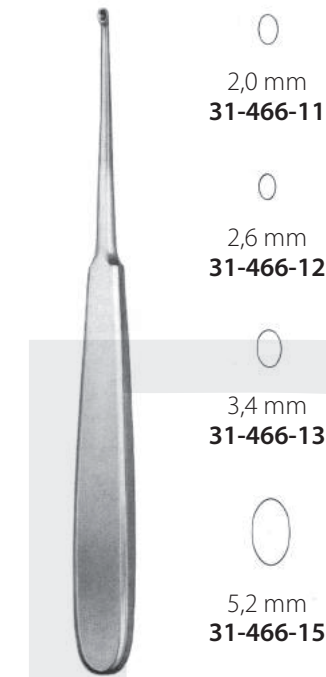

Williger, 17,0 cm



Volkman, 17,0 cm



Spratt, 17,0 cm



Lempert

- | | | |
|----------------------------|-------------------------------|----------------------------|
| 2,0 mm
31-466-11 | Fig. 0000
31-467-01 | Fig. 1
31-467-05 |
| 2,6 mm
31-466-12 | Fig. 000
31-467-02 | Fig. 2
31-467-06 |
| 3,4 mm
31-466-13 | Fig. 00
31-467-03 | Fig. 3
31-467-07 |
| 5,2 mm
31-466-15 | Fig. 0
31-467-04 | Fig. 4
31-467-08 |
| | | Fig. 5
31-467-09 |
| | | Fig. 6
31-467-10 |
-
- | | | |
|-------------------------------|----------------------------|---------------------------------------|
| Fig. 0000
31-468-01 | Fig. 1
31-468-05 | 21,0 cm
1,0 mm
31-469-00 |
| Fig. 000
31-468-02 | Fig. 2
31-468-06 | 21,0 cm
1,7 mm
31-469-01 |
| Fig. 00
31-468-03 | Fig. 3
31-468-07 | 21,0 cm
2,0 mm
31-469-02 |
| Fig. 0
31-468-04 | Fig. 4
31-468-08 | 17,0 cm
2,4 mm
31-469-03 |
| | Fig. 5
31-468-09 | 17,0 cm
2,7 mm
31-469-04 |
| | | 17,0 cm
3,0 mm
31-469-05 |
| | | 17,0 cm
3,3 mm
31-469-30 |
| | | 17,0 cm
31-469-33 |

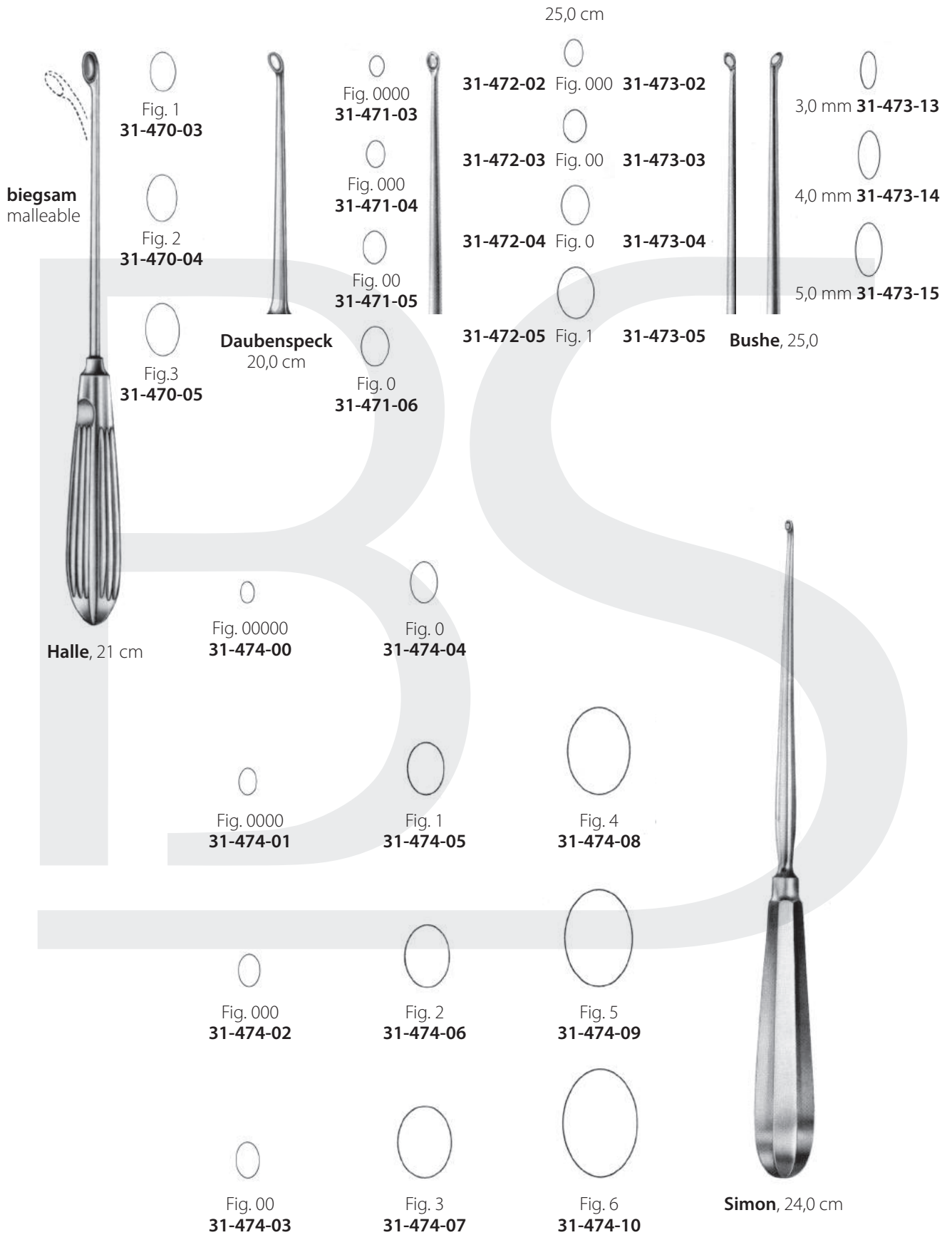

Scharfe Löffel
Bone Curettes

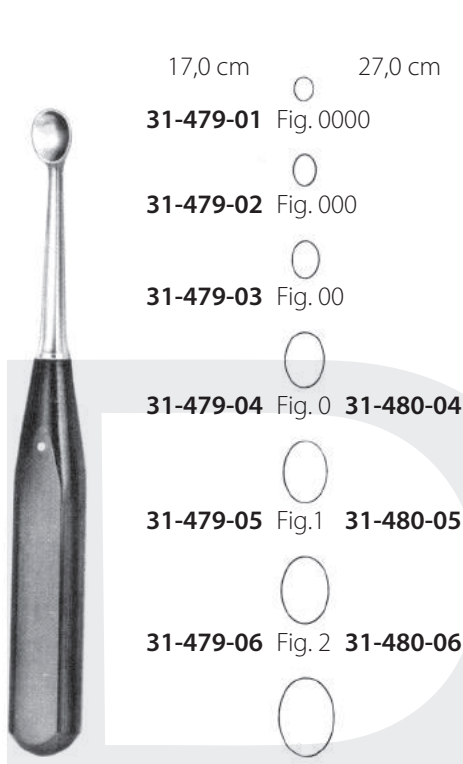

Volkman

- 17,0 cm 27,0 cm
- 31-479-01** Fig. 0000
- 31-479-02** Fig. 000
- 31-479-03** Fig. 00
- 31-479-04** Fig. 0 **31-480-04**
- 31-479-05** Fig. 1 **31-480-05**
- 31-479-06** Fig. 2 **31-480-06**
- 31-479-07** Fig. 3 **31-480-07**

- 17,0 cm 27,0 cm
- 31-479-08** Fig. 4 **31-480-08**
- 31-479-09** Fig. 5
- 31-479-09** Fig. 6



Scoville, 25,0 cm

- 31-481-01**
- 31-481-02**
- 31-481-03**



Bruns, 23,0 cm

- Fig. 0000 Fig. 2
- 31-483-01** **31-483-06**
- Fig. 000 Fig. 3
- 31-483-02** **31-483-07**
- Fig. 00 Fig. 4
- 31-483-03** **31-483-08**
- Fig. 0 Fig. 5
- 31-483-04** **31-483-09**
- Fig. 1 Fig. 6
- 31-483-05** **31-483-10**



Fig. 1	Fig. 2	Fig. 3	Fig. 4	Fig. 5	Fig. 6
31-484-01	31-484-02	31-484-03	31-484-04	31-484-05	31-484-06
31-485-01	31-485-02	31-485-03	31-485-04	31-485-05	31-485-06
31-486-01	31-486-02	31-486-03	31-486-04	31-486-05	31-486-06



14,0 cm **31-502-14**



9,0 cm **31-503-09**
13,0 cm **31-503-13**
18,0 cm **31-503-18**



12,0 cm **31-506-12**



Lewin
17,5 cm **31-508-17**



Reill
17,0 cm **31-511-17**



20,5 cm **31-513-20**

Knochenhaltezangen
Bone Holding Forceps

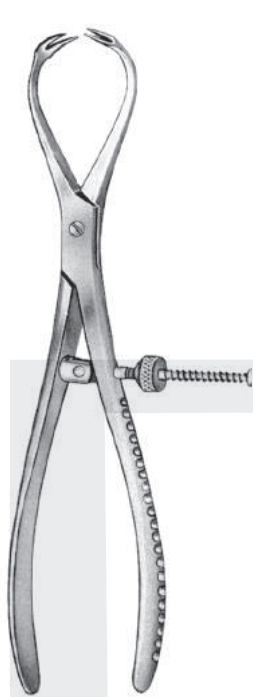

Patellazange
Patella Forceps
17,5 cm **31-516-18**

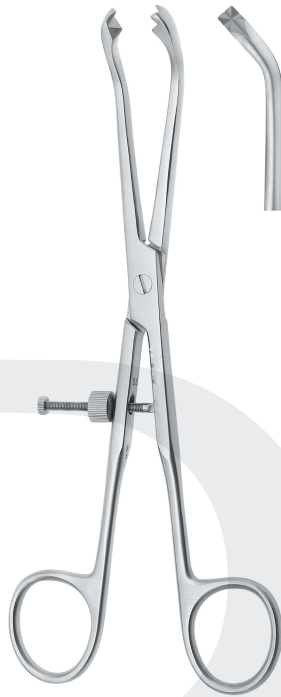

31-517-02

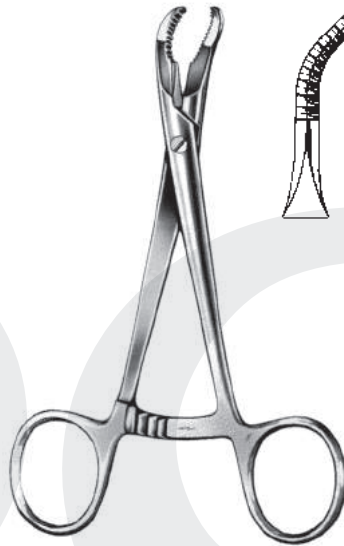

14,0 cm **31-519-14**

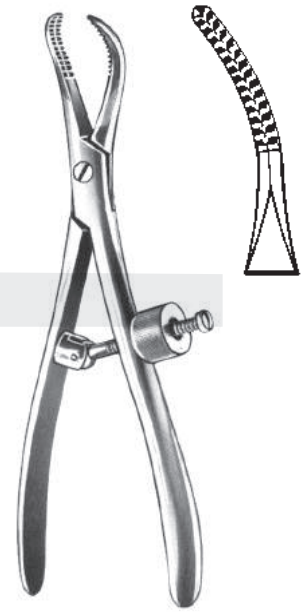

17,0 cm **31-521-17**
23,0 cm **31-521-23**

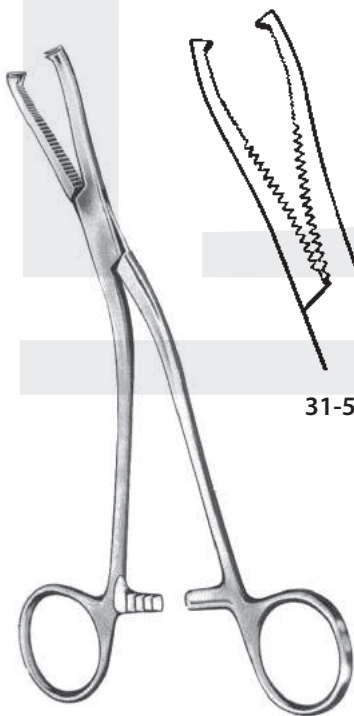

Dingmann, 18,0 cm



31-523-18

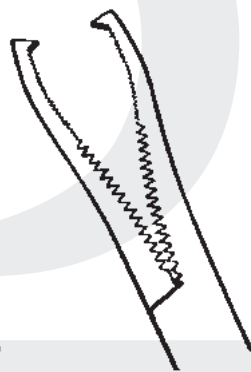

31-523-19



Sequesterzange
Sequestrum Forceps
20,0 cm



31-524-20

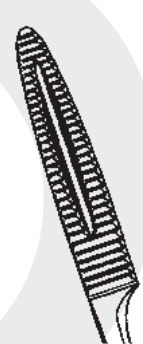

31-525-20

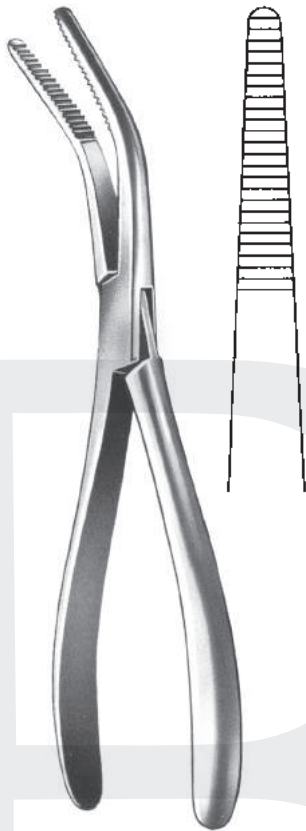

Van Buren
22,5 cm 31-527-23



22,5 cm
31-528-20



Frosch
18,0 cm 31-529-18



Langenbeck
20,0 cm 31-530-20



Fergusson
20,0 cm 31-532-20



Semb
19,0 cm 31-533-19

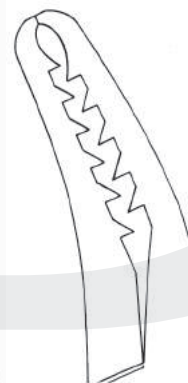

Semb
19,0 cm 31-535-19

Knochenhaltezangen
Bone Holding Forceps



Farabeuf
23,0 cm **31-536-23** 9,0 mm
25,0 cm **31-536-25** 11,0 mm

Farabeuf
25,0 cm **31-538-25** 11,0 mm



Kern-Lane
15,0 cm **31-540-15**, 7,0 mm
17,0 cm **31-540-17**, 7,0 mm
21,0 cm **31-540-21**, 8,0 mm
24,0 cm **31-540-24**, 9,0 mm
33,0 cm **31-540-33**, 10,0 mm
45,0 cm **31-540-45**, 12,0 mm

Kern-Lane
15,0 cm **31-542-15**, 7,0 mm
17,0 cm **31-542-17**, 7,0 mm
21,0 cm **31-542-21**, 8,0 mm
24,0 cm **31-542-24**, 9,0 mm
33,0 cm **31-542-33**, 10,0 mm
45,0 cm **31-542-45**, 12,0 mm

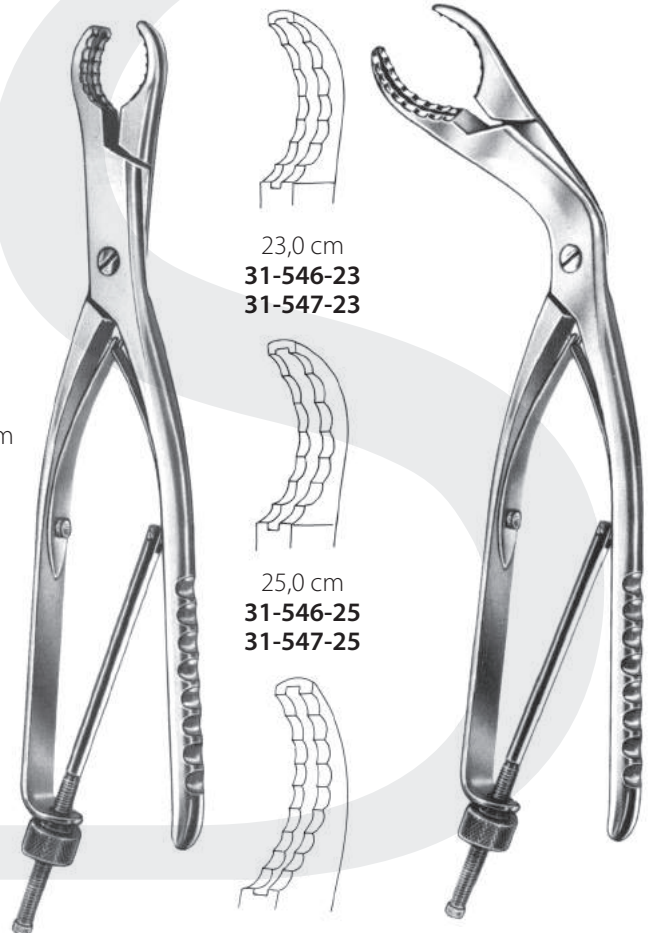

23,0 cm
31-546-23
31-547-23

25,0 cm
31-546-25
31-547-25

Ulrich
31-546-23 - 31-546-28

28,0 cm
31-546-28
31-547-28

Ulrich
31-547-23 - 31-547-28



15,0 cm
31-549-15

19,0 cm
31-549-19

24,0 cm
31-549-24

26,0 cm
31-549-26

28,0 cm
31-549-28

Selbstzentrierend mit Gewindesperre
self-centering with thread fixation



17,0 cm
31-551-17

25,0 cm
31-551-25

26,0 cm
31-551-26

27,0 cm
31-551-27



Verbrugge

Knochenhaltezangen
Bone Holding Forceps

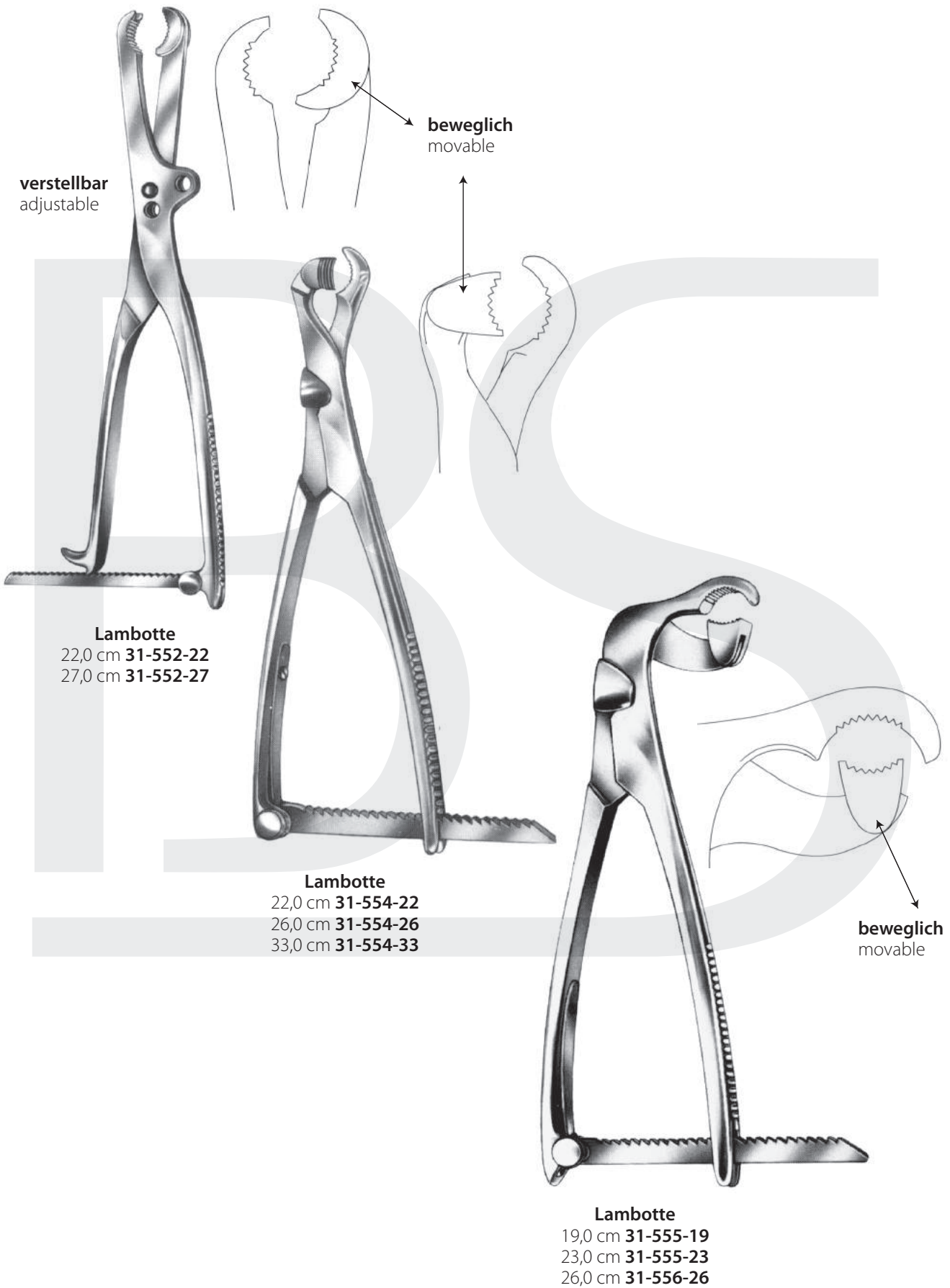

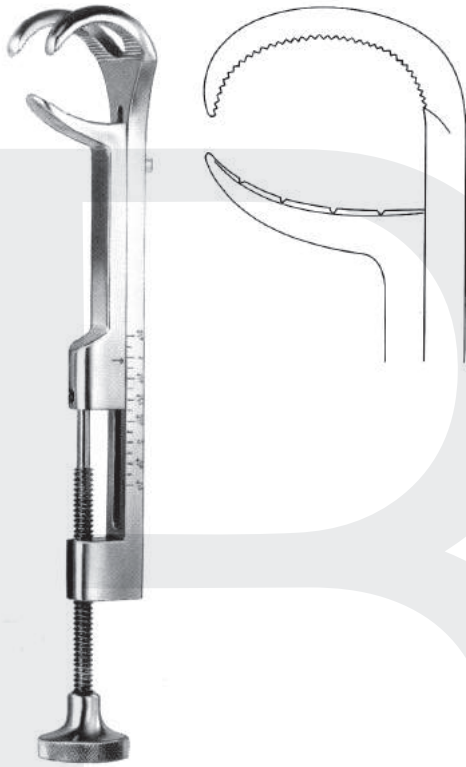

Lowmann
31-561-13 - 31-561-22

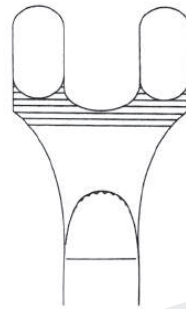

13,0 cm
31-561-13

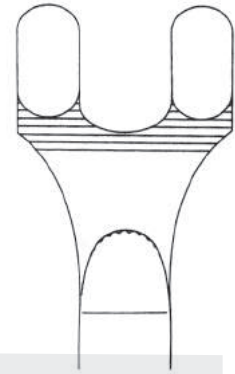

18,0 cm
31-561-18

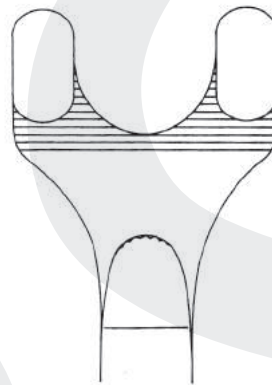

20,0 cm
31-561-20

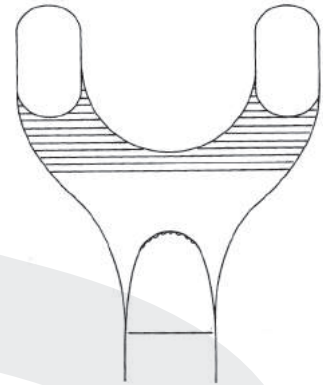

22,0 cm
31-561-22

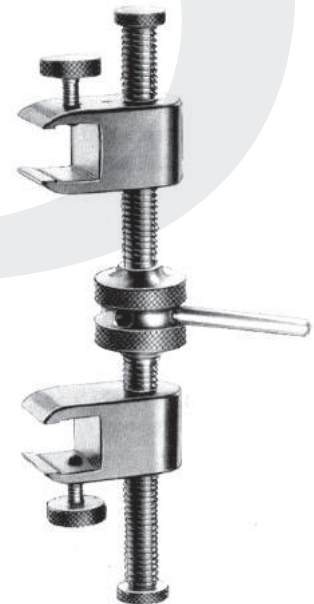

Gerster
15,0 cm **31-564-00**



31-601-01 31-601-02

31-603-01 31-603-02

31-605-01 31-605-02

Synovektomie-Zange
Synovectomy Rongeur
13 cm, 1,2 mm

Synovektomie-Zange
Synovectomy Rongeur
13 cm, 2,0 mm

Stellbrink, 17 cm



31-611-01 31-611-02

31-611-03

Friedmann
12 cm 31-607-12

Luer-Friedmann
14,5 cm 31-607-14

Friedmann-Vickers
14,0 cm 31-608-14

Luer, 15,0 cm



Cleveland

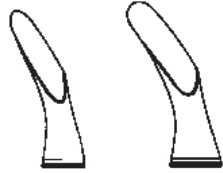

14,0 cm 31-613-14
17,0 cm 31-613-17



Blumenthal, 15,0 cm



31-615-01 31-615-02 31-615-03



Jansen, 17,0 cm

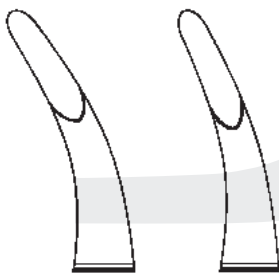

31-617-16 31-617-17



31-618-17



Hartmann
17,0 cm 31-619-17



Lempert, 20,0 cm

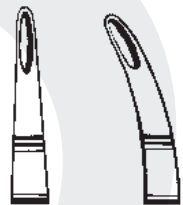

31-622-20 31-623-20

Hohlmeißelzangen
Bone Rongeur Forceps

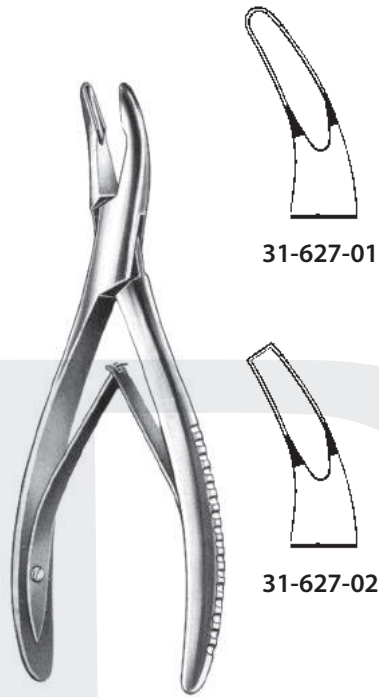

31-627-01



31-627-02

Mead, 16,5 cm



Luer



17,0 cm
31-628-17



17,0 cm
31-629-17



18,0 cm
31-630-18



18,0 cm
31-631-18



Böhler



3,0 mm
15,0 cm
31-640-03

4,0 mm
15,0 cm
31-640-04

5,0 mm
15,0 cm
31-640-05



3,0 mm
15,0 cm
31-641-03

4,0 mm
15,0 cm
31-641-04

5,0 mm
15,0 cm
31-641-05



3,0 mm
15,5 cm
31-641-15



31-636-23



Mayfield
17,0 cm 31-645-17



Marquardt
20,0 cm 31-647-20



Beyer
18,0 cm 31-649-18

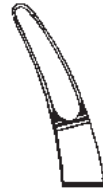

Zaufal-Janson
18,0 cm 31-651-18



Ruskin

18,0 cm 31-653-05
24,0 cm 31-655-05



Echlin, 23,0 cm

31-658-02

31-658-03

31-658-04

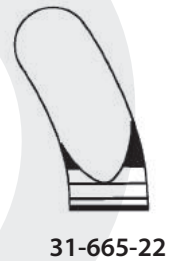
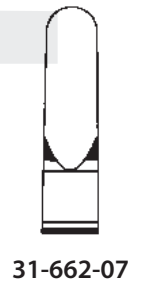

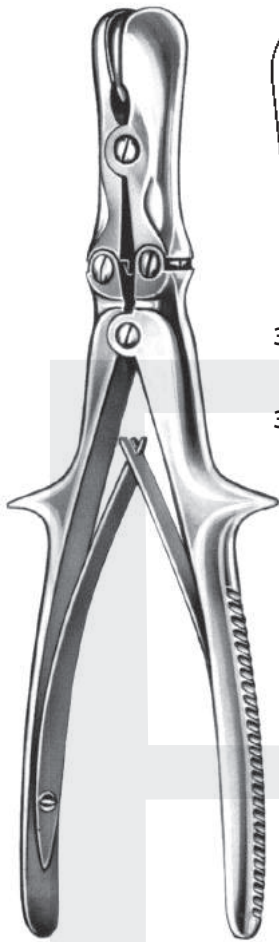

Luer-Stille



23,0 cm
31-666-23

27,0 cm
31-666-27



23,0 cm
31-667-23

27,0 cm
31-667-27



Markwalder
19,0 cm 31-669-19

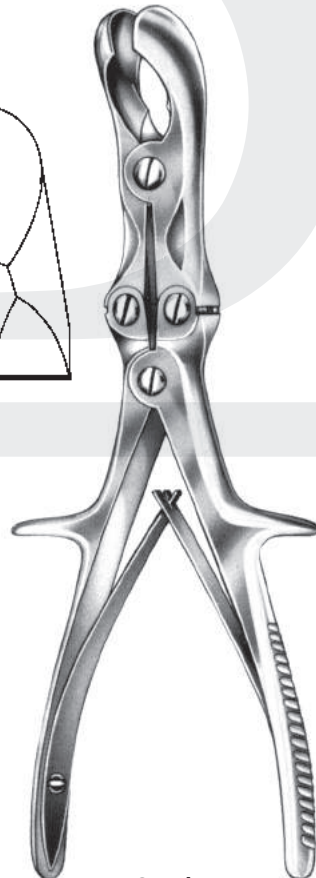

Semb
24,0 cm 31-669-24



31-670-01



31-670-02

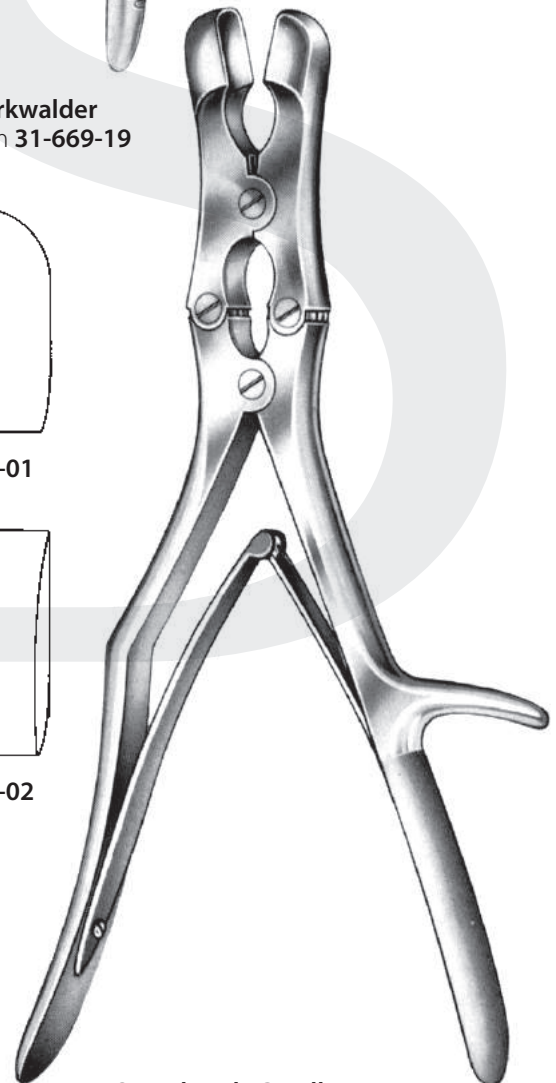

Sauerbruch-Coryllos, 31,0 cm

Knochensplitterzange
Bone Cutting Forceps



Cleveland
15,0 cm **31-701-15**



Cleveland
17,0 cm **31-701-17**



Gardner, 16,0 cm



4,0 mm
31-703-04



6,0 mm
31-703-06



Cottle
19,0 cm **31-704-19**



Liston



14,0 cm
31-706-14



17,0 cm
31-706-17



20,0 cm
31-706-20



22,0 cm
31-706-22



14,0 cm
31-707-14

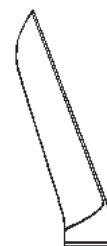

17,0 cm
31-707-17



20,0 cm
31-707-20

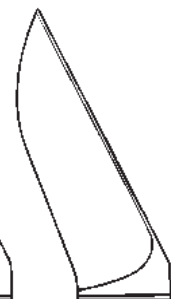

22,0 cm
31-707-22

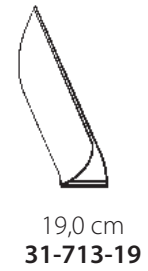
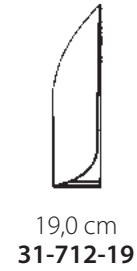
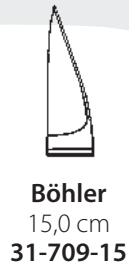

Ruskin-Liston

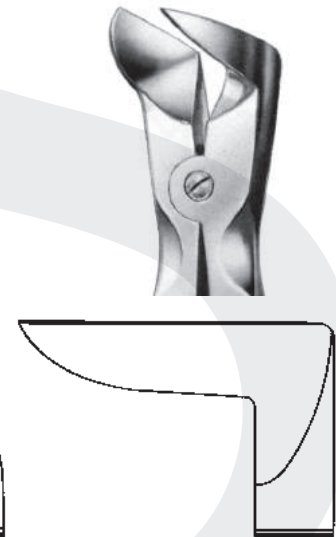

Liston-Stille
27,0 cm
31-717-27

Liston



Liston-Key
27,0 cm 31-719-27



Semb
24,0 cm 31-721-24



20,0 cm 31-738-20
19,5 cm 31-739-19

Bircher-Ganske



Bircher-Ganske
20,0 cm 31-739-20



Martin
20,5 cm 31-740-20

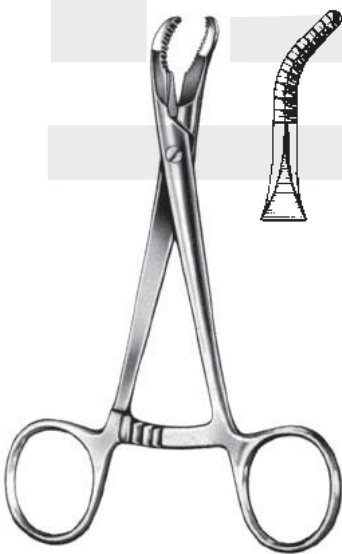

Knorpelfaßzange
Cartilage Seizing Forceps
13,5 cm 31-741-14

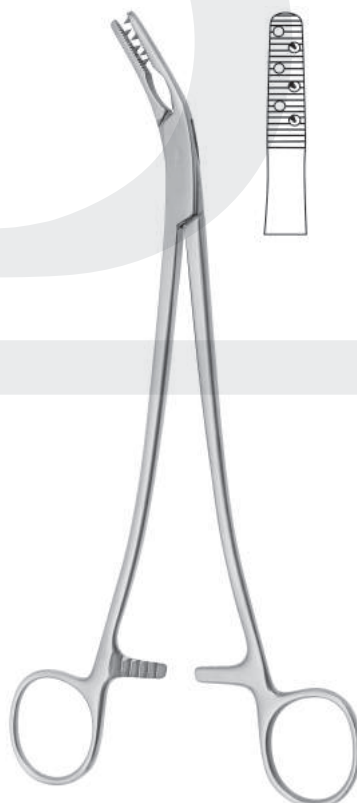

21,0 cm 31-743-21



Neff, 13,5 cm

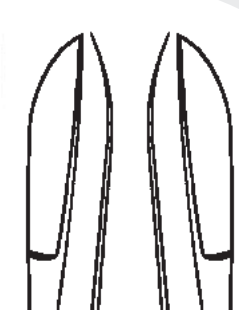

31-742-01 31-747-02

Salenius, 22,0 cm
31-745-01 31-745-02



31-754-01



31-754-02

Bircher, 19,5 cm



Smillie
17,0 cm 31-755-01



Smillie
17,0 cm 31-755-02



Smillie
17,0 cm 31-755-03



Smillie, 14,0 cm



31-760-01 32x19 mm
31-760-02 48x19 mm
31-760-03 57x19 mm



31-760-04 52x13 mm



31-760-05 12x13 mm



Blount, 40 x 4 mm
17,5 cm **31-762-17**



75 x 30 mm
17,0 cm **31-763-17**



Taylor
16,5 cm, 75 x 30 mm **31-764-01**
16,5 cm, 100 x 30 mm **31-764-02**

Sehnenflechtklemme
Tendon Interlacing Forceps

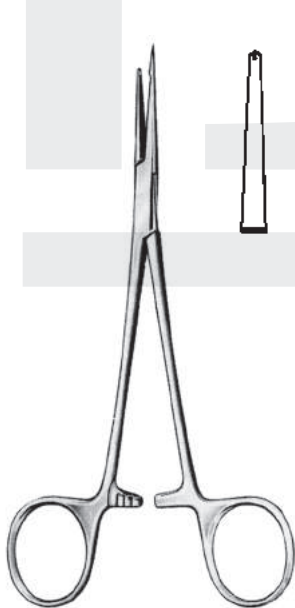

15,0 cm **31-770-15**

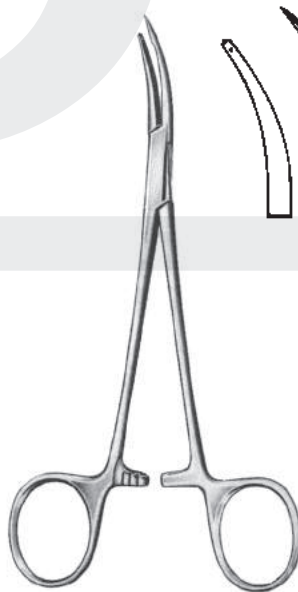

15,0 cm **31-771-15**



Sehnenfaßzange
Tendon Seizing Forceps
12,0 cm **31-772-12**

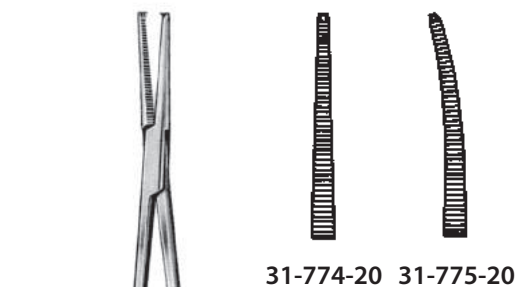

31-774-20 31-775-20



Sehnenfaßzange
Tendon Seizing Forceps
20,5 cm



Sehnenfaßzange
Tendon Seizing Forceps
11,0 cm **31-777-11**



15,0 cm

31-778-15 gerade/straight
31-779-18 gebogen/curved



18,0 cm

31-778-18 gerade/straight
31-779-18 gebogen/curved



24,0 cm

31-778-24 gerade/straight
31-779-24 gebogen/curved



Brand
Sehnenfaßzange
Tendon Seizing Forceps

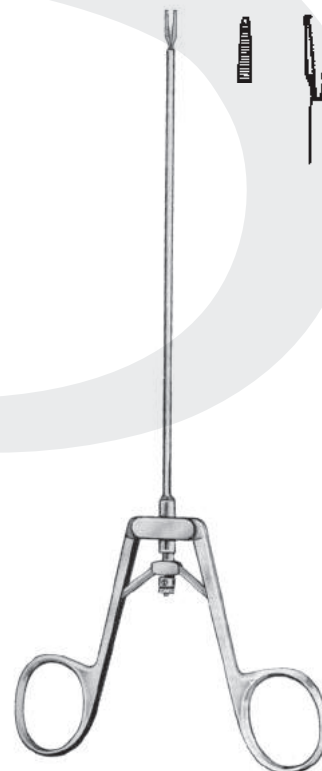

Kleinert-Kutz
Sehnedurchziehzange
Tendon Passing Forceps
20,5 cm **31-781-20**



Kirschner

- 95 x 70 mm **31-801-01**
- 95 x 110 mm **31-801-02**
- 105 x 110 mm **31-801-03**
- 120 x 120 mm **31-801-04**
- 135 x 130 mm **31-801-05**
- 155 x 155 mm **31-801-06**
- 200 x 155 mm **31-801-07**



verstellbar
adjustable

- 40 - 140 **31-802-01**
- 65 - 140 **31-802-02**
- 60 - 220 **31-802-03**

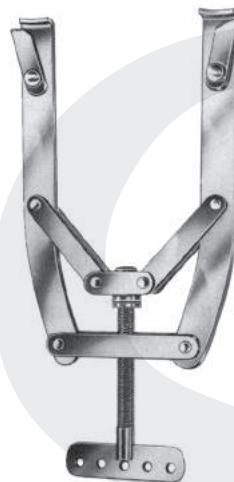

Kirschner, amer. Modell
American type

- max. 105 mm **31-803-01**
- max. 160 mm **31-803-02**
- max. 200 mm **31-803-03**



Böhler

- 16 x 9 mm **31-804-01**
- 21 x 11 mm **31-804-02**
- 21 x 15 mm **31-804-03**



Spannschlüssel mit Klemmbacke
chuck key
with clamping jaws
31-804-01



Gabelschlüssel
Wrench
31-806-01



Zughaken
Traction hook
31-807-00



Zughaken, allein
Traction hook
31-808-00



Fixierscheiben, Paar
Fixation Disc, pair
31-809-00



31-814-00



Handbohrfutter
Spannweite bis Ø 4,5 mm
 Drilling chuck
 for shanks up to Ø 4,5 mm
 6,35 mm **31-813-00**



Handbohrfutter
Spannweite bis 6,35 mm
 Drilling chuck
 for shanks up to 6,35 mm
31-816-00



Spannschlüssel zu Bohrfutter 31-816-00
 Key for drilling chuck **31-816-00**
31-816-01



Cerclage-Draht, weich
 Wire, soft
 10 m x 0,2 mm **31-821-02**
 10 m x 0,3 mm **31-821-03**
 10 m x 0,4 mm **31-821-04**
 10 m x 0,5 mm **31-821-05**
 10 m x 0,6 mm **31-821-06**
 10 m x 0,7 mm **31-821-07**
 10 m x 0,8 mm **31-821-08**
 10 m x 0,9 mm **31-821-09**
 10 m x 1,0 mm **31-821-10**
 10 m x 1,2 mm **31-821-12**
 10 m x 1,5 mm **31-821-15**
 10 m x 2,0 mm **31-821-20**

Cerclage-Draht, TITAN
 Wire, TITAN
 10 m x 0,8 mm **31-821-38**
 10 m x 1,0 mm **31-821-40**



Loute Drahtspanner
 Wire tightener
 22,0 cm **31-822-22**



Demel Drahtspannzange
 Wire tightening forceps
 27,0 cm **31-824-27**



Demel

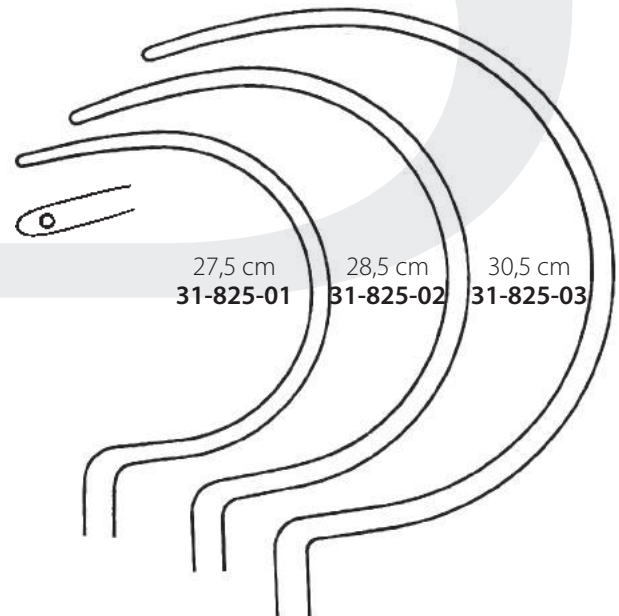

27,5 cm **31-825-01** 28,5 cm **31-825-02** 30,5 cm **31-825-03**

Drahtumführungsinstrument/Wire Guide



15,0 cm 31-830-15
18,0 cm 31-830-18

15,0 cm 31-832-15
20,0 cm 31-832-20

15,0 cm 31-834-15
18,0 cm 31-834-18

31-830-15 - 83-834-18



15,0 cm 31-835-15



18,5 cm 31-836-18



Corwig-Hegar
16,0 cm 31-838-16



14,0 cm 31-850-14

Drahtextension
Wire Extension



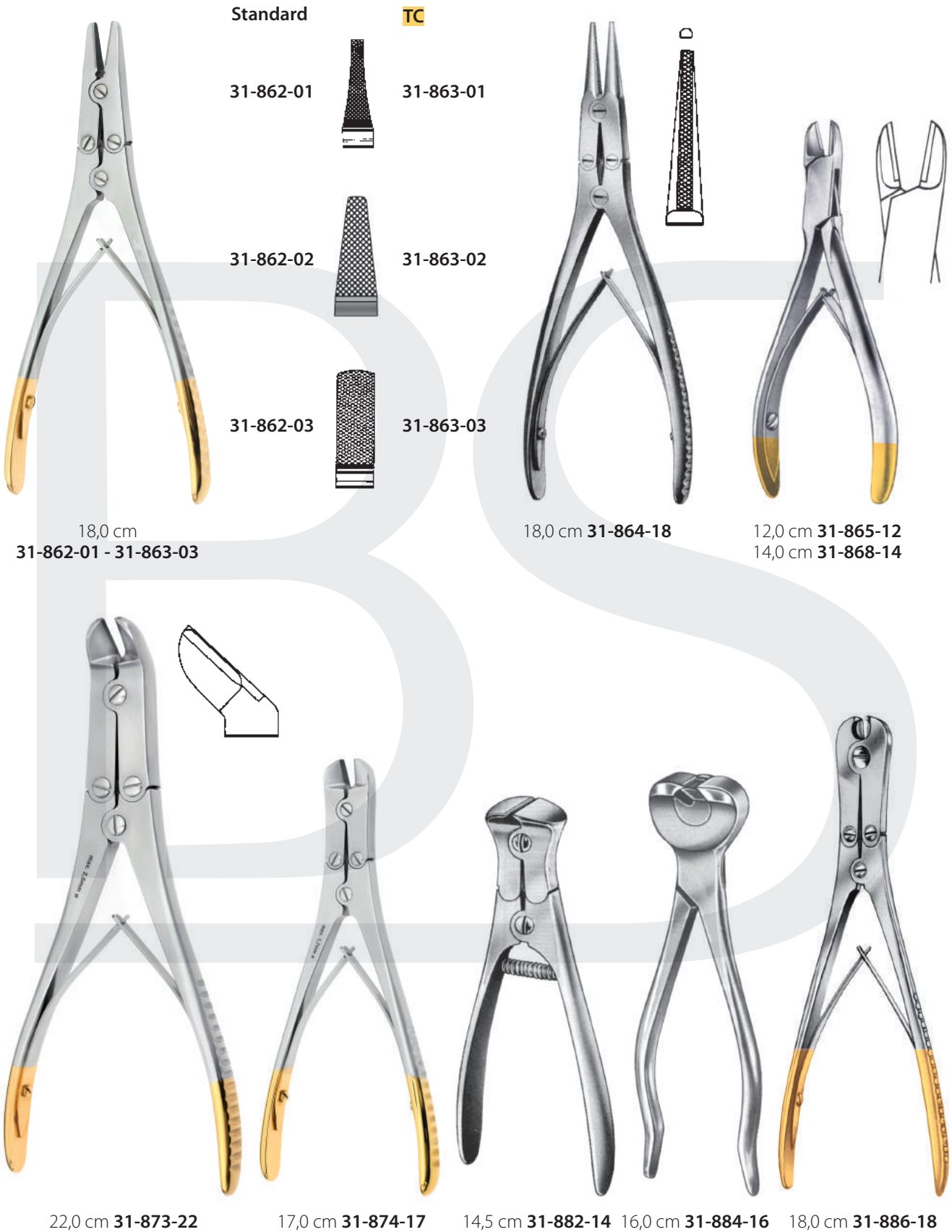



47,0 cm **31-890-47**

57,0 cm **31-890-57**

31-890-98 Ersatzschneide (Paar) für 31-890-47
Spare blade (pair)

31-890-99 Ersatzschneide (Paar) für 31-890-45
Spare blade (pair)

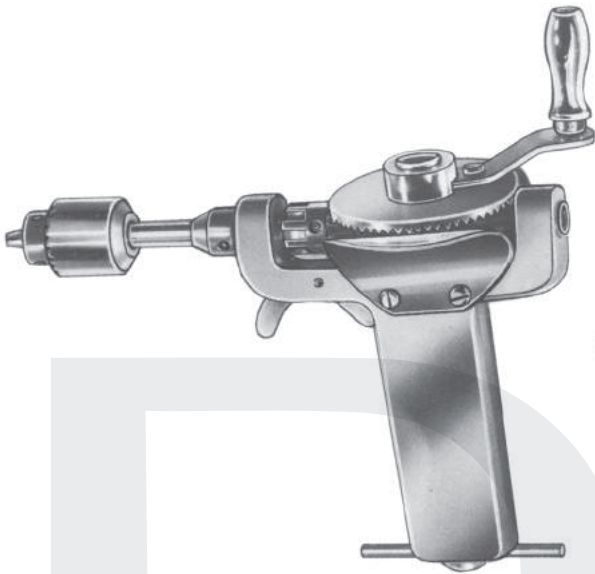

Bunnell
31-909-00



31-914-00

Hudson, komplett
Hudson, complete
31-916-00



Verlängerung
Extension piece
31-916-09

Hudson, allein
Hudson, alone
31-916-10



Hudson
Fig. 1 Ø 9 mm
31-916-01



Hudson
Fig. 2 Ø 14 mm
31-916-02



Hudson
Fig. 3 Ø 16 mm
31-916-03



Hudson
Fig. 3 Ø 22 mm
31-916-04



Cushing
Ø 14 mm
31-916-05



Hudson
Ø 2 mm
31-916-06



Mc Kenzie
Ø 13 mm
31-916-07



Adson
Ø 15 mm
31-916-08

Kirschner Drähte
Kirschner Wire

32

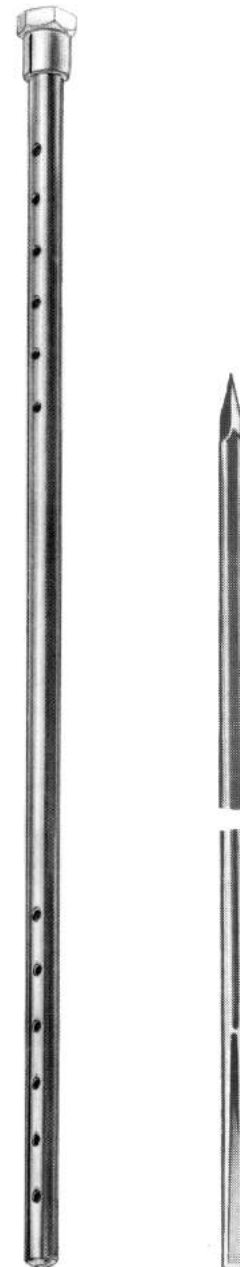

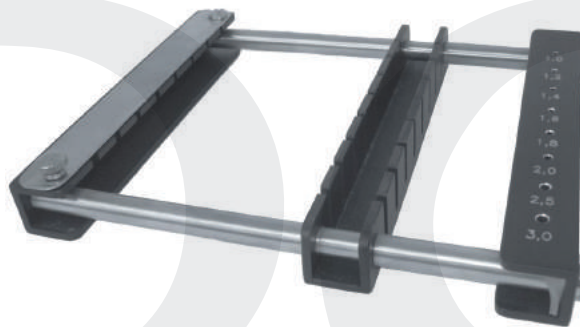

32-005-16 Kirschnerdraht-Spender, 8 Größen für 15 cm Draht
Kirschner Wire Drill racks, 8 sizes for 15 cm

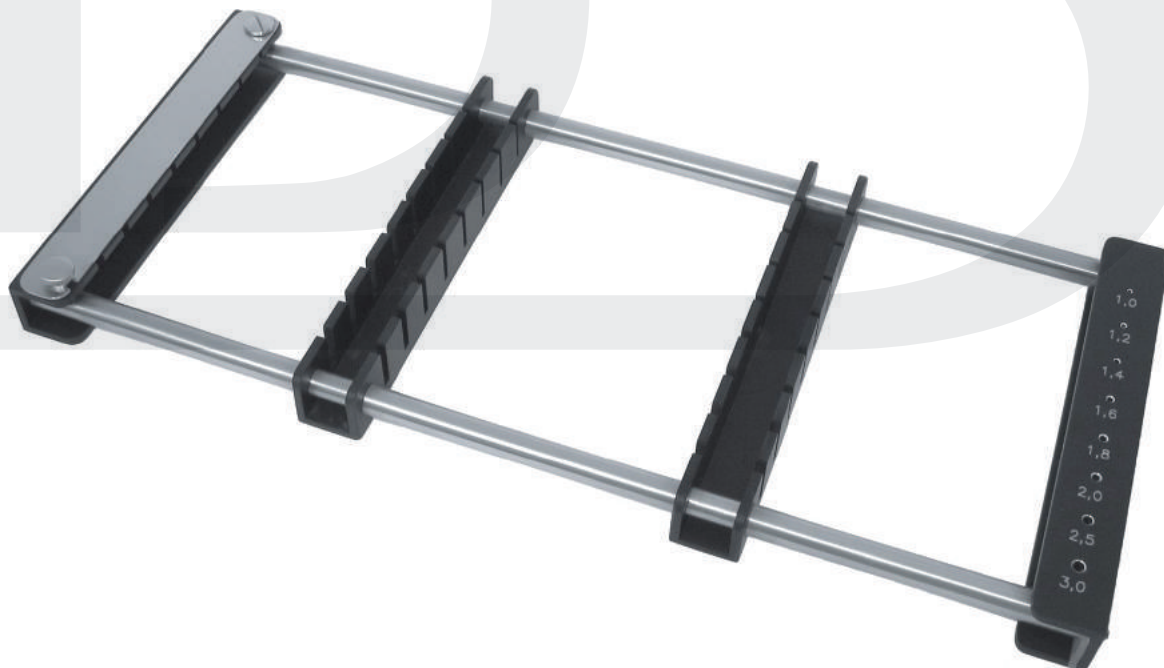

32-005-31 Kirschnerdraht-Spender, 8 Größen für 31 cm Draht
Kirschner Wire Drill racks, 8 sizes for 31 cm

Kirschnerdraht-Spender/Kirschnerdrähte

Kirschner wires dispenser/Kirschner Wires



Drahtdurchmesser-Kennzeichnung auf Spender
Sterilisation und Aufbewahrung im Spender

clear size markings on the dispenser
sterilization and storage in dispenser possible

Trokarspitze/Trocar point

mit flachem Ende
with flat shaft

Kirschner

für Kirschner-Drähte
for Kirschner Wire

32-018-08 0,8 mm 18,0 cm
32-018-10 1,0 mm 18,0 cm
32-018-11 1,1 mm 18,0 cm
32-018-12 1,2 mm 18,0 cm
32-018-13 1,3 mm 18,0 cm
32-018-14 1,4 mm 18,0 cm
32-018-15 1,5 mm 18,0 cm
32-018-16 1,6 mm 18,0 cm
32-018-17 1,7 mm 18,0 cm
32-018-18 1,8 mm 18,0 cm
32-018-20 2,0 mm 18,0 cm
32-018-22 2,2 mm 18,0 cm
32-018-25 2,5 mm 18,0 cm
32-018-30 3,0 mm 18,0 cm

32-033-08 0,8 mm 33,0 cm
32-033-10 1,0 mm 33,0 cm
32-033-11 1,1 mm 33,0 cm
32-033-12 1,2 mm 33,0 cm
32-033-13 1,3 mm 33,0 cm
32-033-14 1,4 mm 33,0 cm
32-033-15 1,5 mm 33,0 cm
32-033-16 1,6 mm 33,0 cm
32-033-17 1,7 mm 33,0 cm
32-033-18 1,8 mm 33,0 cm
32-033-20 2,0 mm 33,0 cm
32-033-22 2,2 mm 33,0 cm
32-033-25 2,5 mm 33,0 cm
32-033-30 3,0 mm 33,0 cm

mm mm Ø	Länge length 60 mm	Länge length 100 mm	Länge length 150 mm	Länge length 310 mm
0,6	32-060-06	32-100-06	32-150-06	32-310-06
0,8	32-060-08	32-100-08	32-150-08	32-310-08
0,9	32-060-09	32-100-09	32-150-09	32-310-09
1,0	32-060-10	32-100-10	32-150-10	32-310-10
1,1	32-060-11	32-100-11	32-150-11	32-310-11
1,2	32-060-12	32-100-12	32-150-12	32-310-12
1,3	32-060-13	32-100-13	32-150-13	32-310-13
1,4	32-060-14	32-100-14	32-150-14	32-310-14
1,5	32-060-15	32-100-15	32-150-15	32-310-15
1,6	32-060-16	32-100-16	32-150-16	32-310-16
1,7	32-060-17	32-100-17	32-150-17	32-310-17
1,8	32-060-18	32-100-18	32-150-18	32-310-18
1,9	32-060-19	32-100-19	32-150-19	32-310-19
2,0	32-060-20	32-100-20	32-150-20	32-310-20
2,2	32-060-22	32-100-22	32-150-22	32-310-22
2,4	32-060-24	32-100-24	32-150-24	32-310-24
2,5	32-060-25	32-100-25	32-150-25	32-310-25
3,0	32-060-30	32-100-30	32-150-30	32-310-30

in Packung á 10 Stück / in packages with 10 pieces
Edelstahl / Premium steel

Weitere Kirschnerdrähte mit Gewindespitzen, Sonderlängen und aus Titan sind möglich.
Further Kirschner Wires with thread tips, other lengths and from Titanium are possible.



Trokarspitze/Trocar point

mm mm Ø	Länge length 60 mm	Länge length 100 mm	Länge length 150 mm	Länge length 310 mm
0,6	32-061-06	32-101-06	32-151-06	32-311-06
0,8	32-061-08	32-101-08	32-151-08	32-311-08
0,9	32-061-09	32-101-09	32-151-09	32-311-09
1,0	32-061-10	32-101-10	32-151-10	32-311-10
1,1	32-061-11	32-101-11	32-151-11	32-311-11
1,2	32-061-12	32-101-12	32-151-12	32-311-12
1,3	32-061-13	32-101-13	32-151-13	32-311-13
1,4	32-061-14	32-101-14	32-151-14	32-311-14
1,5	32-061-15	32-101-15	32-151-15	32-311-15
1,6	32-061-16	32-101-16	32-151-16	32-311-16
1,7	32-061-17	32-101-17	32-151-17	32-311-17
1,8	32-061-18	32-101-18	32-151-18	32-311-18
1,9	32-061-19	32-101-19	32-151-19	32-311-19
2,0	32-061-20	32-101-20	32-151-20	32-311-20
2,2	32-061-22	32-101-22	32-151-22	32-311-22
2,4	32-061-24	32-101-24	32-151-24	32-311-24
2,5	32-061-25	32-101-25	32-151-25	32-311-25
3,0	32-061-30	32-101-30	32-151-30	32-311-30

mit rundem Ende
with round shaft

in Packung á 10 Stück / in packages with 10 pieces

Kirschner



Trokarspitze/Trocar point

mm mm Ø	Länge length 100 mm	Länge length 150 mm	Länge length 310 mm
0,6	32-102-06	32-152-06	32-312-06
0,8	32-102-08	32-152-08	32-312-08
0,9	32-102-09	32-152-09	32-312-09
1,0	32-102-10	32-152-10	32-312-10
1,1	32-102-11	32-152-11	32-312-11
1,2	32-102-12	32-152-12	32-312-12
1,3	32-102-13	32-152-13	32-312-13
1,4	32-102-14	32-152-14	32-312-14
1,5	32-102-15	32-152-15	32-312-15
1,6	32-102-16	32-152-16	32-312-16
1,7	32-102-17	32-152-17	32-312-17
1,8	32-102-18	32-152-18	32-312-18
1,9	32-102-19	32-152-19	32-312-19
2,0	32-102-20	32-152-20	32-312-20
2,2	32-102-22	32-152-22	32-312-22
2,4	32-102-24	32-152-24	32-312-24
2,5	32-102-25	32-152-25	32-312-25
3,0	32-102-30	32-152-30	32-312-30

mit Trokarende
with trocar point

in Packung á 10 Stück / in packages with 10 pieces

Weitere Kirschnerdrähte mit Gewindespitzen, Sonderlängen und aus Titan sind möglich.
Further Kirschner wires with threaded tips, various lengths and made of Titanium are available.

Verband- und Gips Instrumente
Bandage and Cast Instruments

41



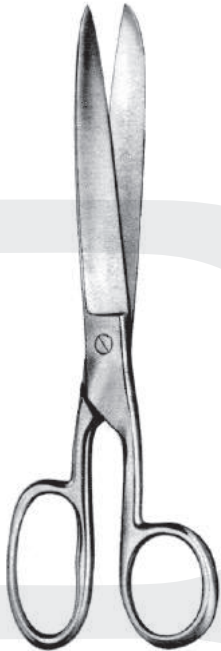

Smith
18,0 cm **41-000-18**
20,0 cm **41-000-20**

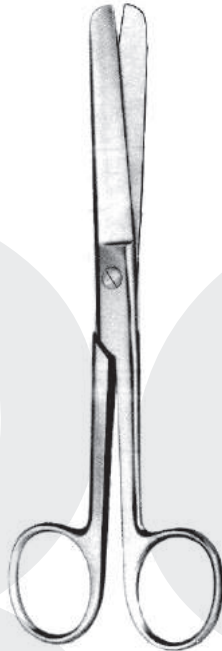

Lange
18,0 cm **41-002-18**



Lorenz
23,0 cm **41-003-23**



Knowles
14,0 cm **41-005-14**



Knowles
14,0 cm **41-006-14**



Lister
9,0 cm **41-007-09**
11,0 cm **41-007-11**
14,0 cm **41-007-14**
16,0 cm **41-007-16**
18,0 cm **41-007-18**
20,0 cm **41-007-20**



Lister, TC
18,0 cm **41-009-18**



Lister, TC
18,0 cm **41-009-18 B**



Lister, excentric
16,0 cm **41-011-16**
18,0 cm **41-011-19**



gezahnt
serrated



Esmarch, ungezahnt
20,0 cm **41-013-20**
23,0 cm **41-013-23**

Esmarch, gezahnt
20,0 cm **41-013-21**
23,0 cm **41-013-24**



Bergmann
23,0 cm **41-015-23**



Bruns, gezahnt
23,0 cm **41-017-24**

Bruns
23,0 cm **41-017-23**
23,0 cm **41-017-23 SC**



Bruns
23,0 cm **41-019-23**



Universal, 15,0 cm

- 15,0 cm **41-021-15** schwarz/black
- 15,0 cm **41-023-15** grün/green
- 15,0 cm **41-025-15** blau/blue
- 15,0 cm **41-027-15** rot/red
- 15,0 cm **41-029-15** gelb/yellow

Universal, 18,0 cm

- 18,0 cm **41-021-18** schwarz/black
- 18,0 cm **41-023-18** grün/green
- 18,0 cm **41-025-18** blau/blue
- 18,0 cm **41-027-18** rot/red
- 18,0 cm **41-029-18** gelb/yellow



Seutin Gipschere
Cast Scissors
23,0 cm **41-030-23**

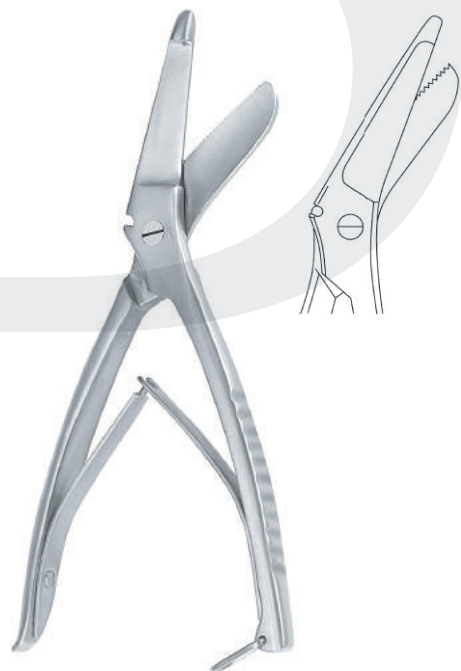

Gips- und Kleiderschere
Cast and Bandage Scissors
20,0 cm **41-031-20**



Stille
23,0 cm **41-033-23**
26,0 cm **41-033-26**
37,0 cm **41-033-37**

Henning
28,0 cm **41-040-28**

Beeson
30,0 cm **41-042-30**



Wolff
Gipsabreißzange
Cast Breakers

18,0 cm **41-045-18**
24,0 cm **41-045-24**



Engel
Gipssäge
Cast Saw

15,0 cm **41-046-14**



Hopkins
20,0 cm **41-048-20**



Esmarch
18,0 cm **41-050-18**



Reiner
18,5 cm **41-052-18**

Gipsmesser
Cast Knives



220 V **41-100-00** komplett/complete
110 V **41-100-01** komplett/complete

**mit 2 Sägeblättern (Ø 50 + 65 mm) und
2 Schraubenschlüsseln, Schutzklasse II nach DIN EN 60601,
Motorschutzschalter und schutzisoliert.**

with 2 saw blades (Ø 50 + 65 mm) and
2 wrenches, protection class II acc. to DIN EN 60601,
emergency switch and shock proof.

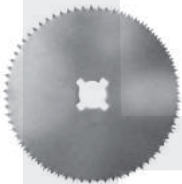

Sägeblatt für Gips und Hartverbände
Saw Blade for cast sand fibre-glass dressings
Ø 50 mm **41-120-50**
Ø 65 mm **41-120-65**



220 V **41-105-00**
110 V **41-105-01**

Oszillierende Gipssäge mit Absaugung
Oscillating Plaster saw with vacuum

Soft-CAST Scheren „CLASSIC“, 18 cm



Soft-CAST Scheren „CONTUR“, 12 cm





CAST 100 M

Soft-CAST Scheren „CLASSIC“, Multicolor, 18 cm



CAST 110 M

Soft-CAST Scheren „CONTUR“, Multicolor, 12 cm

CAST-Scheren CLASSIC und CONTUR sind
auch als Linkshänder-Modelle erhältlich
www.cast-scheren.de

CAST-Scheren CLASSIC and CONTUR is
also available for left-hander.
www.cast-scheren.de

Nagel- und Fußpflege
Nail Care Products

43





Baby-Nagelschere
Baby-Nail scissors
8,5 cm **43-005-08**



Nagelschere
Nail scissors
9,0 cm **43-006-09**
10,0 cm **43-006-10**



Nagelschere
Nail scissors
9,0 cm **43-007-09**
10,0 cm **43-007-10**



Nagelschere
Nail scissors
9,0 cm **43-008-09**
10,0 cm **43-008-10**



Nagelschere
Nail scissors
9,0 cm **43-009-09**
10,0 cm **43-009-10**



Nagelhautschere
Cuticle Removers
Nail and Skin
9,0 cm **43-014-09**



Nagelhautschere
Cuticle Removers
Nail and Skin
9,0 cm **43-015-09**



Hautzange
Cuticle Removers
10,5 cm **43-018-02**

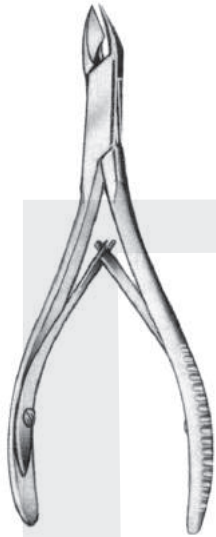

Hautzange
 Cuticle Removers
 11,0 cm **43-021-11**
 13,0 cm **43-021-13**



Nagelzange mit Feder
 Nail cutter with spring
 12,0 cm **43-022-12**



Nagelzange mit Feder
 Nail cutter with spring
 11,0 cm **43-023-11**
 13,0 cm **43-023-13**



Turnbull
Nagelzange mit Feder
 Nail cutter with spring
 11,0 cm **43-024-11**
 13,0 cm **43-024-13**



Nagelzange mit Feder und Schluß
 Nail cutter with spring
 14,0 cm **43-025-14**



Nagelzange mit Feder und Schluß
 Nail cutter with spring
 14,0 cm **43-026-14**



Radolf
Nagelausreißzange
 Nail extracting forceps
 13,0 cm **43-030-13**



Nagelfeile
 File
 10,0 cm
43-032-10



Nagelfeile
 File
 12,0 cm
43-032-12



Nagelfeile
File

11,0 cm **43-033-11**

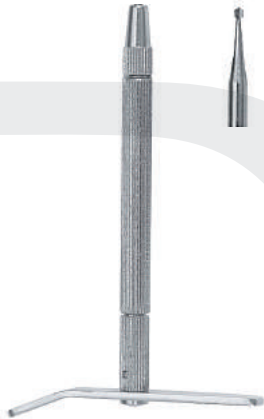

Fingernagel-Bohrer, inkl. 3 Bohrer
Fingernail drill, inclusive 3 drill points

43-034-00



Schwesterngarnitur, 2-teil., komplett
Nail scissors and file, Set

43-040-00



Crede
Callus plane

43-050-00

Ersatzklingen/1 Pack = 10 St.
Spare blades/pack = 10 pcs.

43-050-01



Ralk
Splitterzange
Splinter forceps
15 cm



43-054-15



43-055-15



Peet
Splitterzange
Splinter forceps
11,5 cm **43-057-11**



Stieglitz
Splitterzange
Splinter forceps
13,5 cm



43-058-13

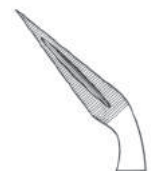

43-059-13



Davis
Sterilisierpinzette
Sterilizing forceps
16,0 cm **43-060-16**
20,0 cm **43-060-20**
24,0 cm **43-060-24**



Cheate
Sterilisierzange
Sterilizing forceps
28,0 cm **43-061-28**



Universal
Sterilisierzange
Sterilizing forceps
20,0 cm **43-063-20**
30,0 cm **43-063-30**



Universal
Sterilisierzange
Sterilizing forceps
20,0 cm **43-062-20**
30,0 cm **43-062-30**



Sterilisierzange
Sterilizing forceps
20,0 cm **43-064-20**
30,0 cm **43-064-30**



Sterilisierzange
Sterilizing forceps
23,0 cm **43-066-23**

Schüsseln, Schalen, Dosen
Bowls, Dishes, Containers

45



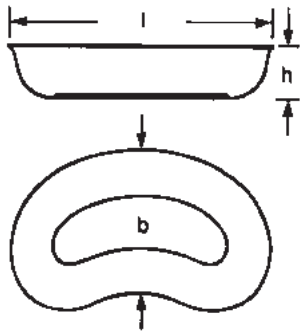

l x b x h
170x100x35 mm **45-100-17**
200x100x35 mm **45-100-20**
250x140x40 mm **45-100-25**
270x150x40 mm **45-100-27**

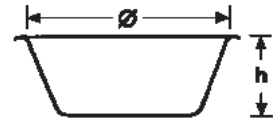

Ø	h		
150 mm,	75 mm	45-101-16	0,75l
160 mm,	75 mm	45-101-17	1,0l
220 mm,	75 mm	45-101-22	2,0l
260 mm,	120 mm	45-101-27	4,5l



Ø	h		
80 mm,	35 mm	45-102-08	0,1l
90 mm,	55 mm	45-102-09	0,2l
100 mm,	65 mm	45-102-10	0,3l
120 mm,	70 mm	45-102-13	0,4l



Ø	h		
40 mm,	19 mm	45-103-04	0,02l
61 mm,	30 mm	45-103-06	0,06l
85 mm,	40 mm	45-103-08	0,16l
116 mm,	55 mm	45-103-11	0,4l
147 mm,	75 mm	45-103-14	1,0l
210 mm,	90 mm	45-103-18	2,5l

Deckel, allein
Lid, only



Ø	
50 mm	45-107-50
75 mm	45-107-75
100 mm	45-107-98

Deckel mit Schlitz
Lid with opening



Ø	
50 mm	45-107-51
75 mm	45-107-76
100 mm	45-107-99



Ø	h	
30 mm	95 mm	45-107-01
50 mm	100 mm	45-107-02
50 mm	130 mm	45-107-03
50 mm	175 mm	45-107-04
80 mm	130 mm	45-107-06
80 mm	175 mm	45-107-07
100 mm	200 mm	45-107-08



mit Graduierung/graduated
0,025 | 45-109-01
0,050 | 45-109-02



Mundbecher
Metal Cup
Ø h
75 mm, 100 mm **45-110-09**



Dose für Watte, Tampons
Containers for cotton, pellets

mit Deckel/with lid		
Ø	h	
60 x 60 mm		45-111-01
85 x 85 mm		45-111-02
100 x 50 mm		45-111-03
100 x 100 mm		45-111-04
120 x 120 mm		45-111-06
150 x 150 mm		45-111-07

Dose für Watte, Tampons
Containers for cotton, pellets

ohne Deckel/without lid		
Ø	h	
60 x 60 mm		45-111-11
85 x 85 mm		45-111-12
100 x 50 mm		45-111-13
100 x 100 mm		45-111-14
120 x 120 mm		45-111-16
150 x 150 mm		45-111-17



0,10 | **45-114-10**
0,25 | **45-114-13**
0,50 | **45-114-14**
1,00 | **45-114-15**
2,00 | **45-114-16**

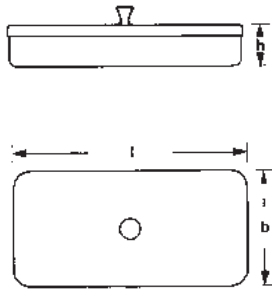

Deckel mit Knopf/Lid with knob

l x b x h
165 x 85 x 35 mm **45-122-01**
200 x 100 x 50 mm **45-122-03**
230 x 150 x 50 mm **45-122-05**
300 x 200 x 50 mm **45-122-07**

Deckel ohne Knopf/Lid without knob

l x b x h
165 x 85 x 35 mm **45-124-01**
200 x 100 x 50 mm **45-124-03**
230 x 150 x 50 mm **45-124-05**
300 x 200 x 50 mm **45-124-07**

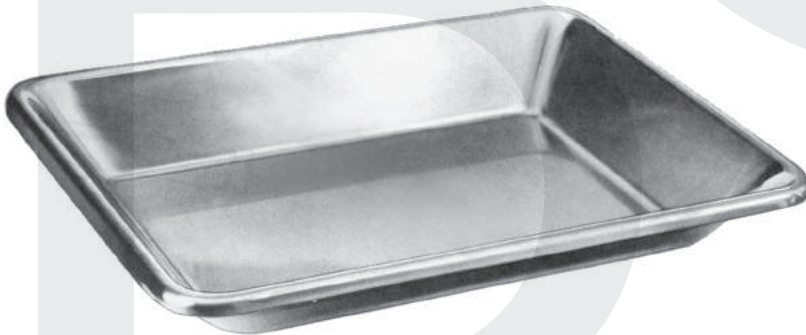
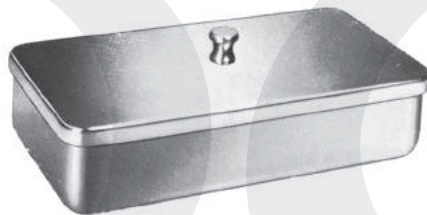

l x b x h
330 x 225 x 30 mm **45-126-01**
355 x 255 x 30 mm **45-126-02**
330 x 225 x 55 mm **45-126-03**
355 x 255 x 55 mm **45-126-04**
420 x 320 x 50 mm **45-126-06**

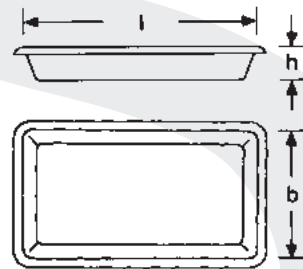

l x b x h
195 x 145 x 10 mm **45-128-01**
280 x 140 x 10 mm **45-128-02**
290 x 185 x 10 mm **45-128-03**
320 x 220 x 10 mm **45-128-04**
380 x 270 x 10 mm **45-128-06**

Sterilisation
Sterilization

47





Nadeldose, komplett Ø 65 x 15 mm **47-100-00**
Needle case, complete
Nadel-Außendose, allein Ø 65 x 15 mm **47-100-64**
Exterior box, only
Nadel-Innendose, allein Ø 62 x 15 mm **47-100-65**
Interior box, only

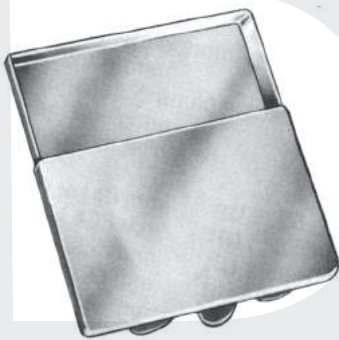

Nadeldose, ungelocht
Needle case
50x25x5 mm **47-102-01**
65x40x8 mm **47-102-02**
75x25x5 mm **47-102-03**



Nadeldose, gelocht
Needle case, perforated
50x25x5 mm **47-102-11**
65x40x8 mm **47-102-12**
75x25x5 mm **47-102-13**



Nadelkasten, ungelocht
Needle case
150x95x13 mm **47-110-01**



Nadelkasten, gelocht
Needle case, perforated
150x95x13 mm **47-110-02**

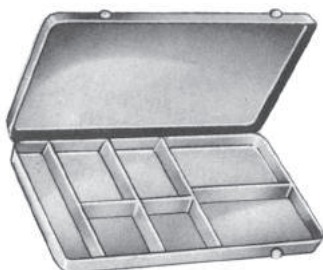

Nadelkasten, ungelocht
Needle case
150x95x13 mm **47-112-01**



Nadelkasten, gelocht
Needle case perforated
150x95x13 mm **47-112-02**



**Sauerbruch
Nadelkasten, perforiert**
Needle case, perforated
210x125x17 mm **47-120-00**



Sterilbehälter mit Kornzange
Sterilized Container with Dressing Forceps
25,0 cm **47-200-25**

Inhaltsverzeichnis

Index

A	
Abortuslöffel	457
Abortuszangen	456, 467
Abraham Tonsillenmesser	18, 306
Absaugküretten	445, 446
Abszessmesser	19
Adlerkreuz Pinzetten	96
Adson Bohrer	547
Adson Klemmen	120, 126
Adson Nadelhalter	249
Adson Nervhaken	291
Adson Pinzetten	88, 93, 98, 112-114, 120, 126
Adson Raspatorien	502
Adson Saugrohr	30
Adson Wundsperrer	228, 230, 231
Adson-Brown Pinzetten	98, 114
Agnew Parazentesenadel	344
Alexander Biopsiezange	450
Alexander Flachmeißel	491
Alexander Hohlmeißel	492
Alexander Raspatorium	504, 505
Allis Organfasszangen	180, 181
Allis-Adair Fasszangen	181
Allison Lungenspatel	375
Allis-Thoms Fasszangen	180
Alm Wundsperrer	224
Amniotom	441
Amputation	481-485
Amputationsmesser	14
Anal Spreizer	416
Anastomosenklemmen	410-412
Anatomische Pinzetten	86-90
Anderson-Adson Wundsperrer	228
Anlegezange f. Bulldogklemmen	143
Anlegezangen f. Clips	284, 285
Anuskope	415
Aorta Dilatatoren	384
Applikationsinstrument	352
Arruga Nadelhalter	252
Arterienklemmen	117-126
Ash Septumzange	330
Atraumatische Bulldog Klemmen	142, 153
Atraumatische Klemmen	145, 146-172
Atraumatische Pinzetten	99-100
Atriumhaken	389
Aufricht Nasenretraktor	327
Aufricht Raspeln	513
Austin Pinzetten	105
Auvard Scheidenspekula	434
Ayre Myommesser	17

A	
Abortuslöffel	457
Abortuszangen	456, 467
Abraham Tonsillennmesser	18, 306
Absaugküretten	445, 446
Abszessmesser	19
Adlerkreuz Pinzetten	96
Adson Bohrer	547
Adson Klemmen	120, 126
Adson Nadelhalter	249
Adson Nervhaken	291
Adson Pinzetten	88, 93, 98, 112-114, 120, 126
Adson Raspatorien	502
Adson Saugrohr	30
Adson Wundsperrerr	228, 230, 231
Adson-Brown Pinzetten	98, 114
Agnew Parazentesenadel	344
Alexander Biopsiezange	450
Alexander Flachmeißel	491
Alexander Hohlmeißel	492
Alexander Raspatorium	504, 505
Allis Organfasszangen	180, 181
Allis-Adair Fasszangen	181
Allison Lungenspatel	375
Allis-Thoms Fasszangen	180
Alm Wundsperrerr	224
Amniotom	441
Amputation	481-485
Amputationsmesser	14
Anal Spreizer	416
Anastomosenklemmen	410-412
Anatomische Pinzetten	86-90
Anderson-Adson Wundsperrerr	228
Anlegezange f. Bulldogklemmen	143
Anlegezangen f. Clips	284, 285
Anuskope	415
Aorta Dilatatoren	384
Applikationsinstrument	352
Arruga Nadelhalter	252
Arterienklemmen	117-126
Ash Septumzange	330
Atraumatische Bulldog Klemmen	142, 153
Atraumatische Klemmen	145, 146-172
Atraumatische Pinzetten	99-100
Atriumhaken	389
Aufricht Nasenretraktor	327
Aufricht Raspeln	513
Austin Pinzetten	105
Auvard Scheidenspekula	434
Ayre Myommesser	17
B	
Babcock Fasszangen	179
Babinsky Perkussionshammer	2
Baby-Kocher Darmklemmen	401
Backhaus Tuchklemmen	182
Bahnson Klemmen	152
Bailey Rippenkontraktor	374
Bakes Gallenkanalsonden	421
Balfour Bauchdeckenhalter	239, 240
Ballenger Fasszangen	176
Ballenger Schwingmesser	324
Ballenger Tonsillenfaßzange	304
Barraquer Nadelhalter	254, 280
Barraquer Pinzette	103
Barth Scharfer Löffel	340
Bauchdeckenhalter	233-244
Bauchspatel	210-212
Beacham Amniotom	441
Beck Klemmen	150
Beckenzirkel	453
Beckmann Nasenspekula	317
Beckmann Ringmesser	309
Beckmann Wundsperrerr	231, 232
Beebe Scheren	67
Beer Pinzette	103
Beeson Gipsspreizer	560
Belucci Ohrscheren	348, 349
Bengolea Klemmen	119, 125
Bergmann Verbandscheren	558
Berliner Perkussionshammer	2
Bernhard Tuchklemmen	182
Bertilion Cephalometer	4
Bethune Rippenschere	361
Betram Tuchklemmen	183
Beuse Scheren	48
Beyer Hohlmeißelzangen	531
Biemer Gefäßspreizer	391
Billeau Ohrschlingen	340
Biopsie Zangen	418, 448-450
Bircher Meniskusmesser	538
Bircher-Ganske Faßzangen	537
Birkett Klemmen	132
Bishop Lippenhalter	303
Blake Embolusfaßzangen	388
Blake Gallensteinzangen	424
Blakesley Nasenzangen	332
Blasensperrerr	233
Blohmke Tonsillenfaßzange	304
Blount Knochenhebel	511
Blount Meniskushaken	539
Blumenthal Hohlmeißelzangen	529
Böhler Extensions-Bügel	541
Böhler Hohlmeißelzangen	530
Böhler Knochensplitterzangen	535
Bolzschneider	546
Bonn Scheren	54
Bonney Pinzetten	96, 113, 114
Bose Trachealhäkchen	313
Böttcher Schere	49
Bowman Sonden	23
Boys-Allis Fasszangen	181
Bozemann Nadelhalter	271
Bozemann Tupferzangen	174
Brainbridge Klemmen	121, 154
Brand Sehnenfasszangen	540
Braun Hakenzange	440, 443
Braun Uterusdepressor	439
Braun-Stadler Scheren	40
Breisky Scheidenspekula	433
Brodie Hohlsonde	23
Brom Wundhaken	223
Broncho-Oesophagos Zangen	315
Bronchus Klemmen	141
Brophy Pinzetten	90, 95
Brown Pinzetten	97
Brünings Ansatzrohr	312
Brünings Septummesser	320
Brünings Septumzangen	329
Brünings Tonsillennmesser	18, 306
Brünings Tonsillenschnürer	306
Brünings Zangenaufsätze	312
Brünings Zungenspatel	299
Brunner Führungssonden	259, 260
Brunner Rektumklemme	411
Brunner Rippenschere	362
Brunner Wundhaken	197
Bruns Gipsschere	557
Bruns Scharfe Löffel	517, 520
Bruststützen	303
Buck Fremdkörperinstrument	342

Buck Ohrküretten	340
Buck Perkussionshammer	2
Buck Scheren	66
Buelau Trokar	26
Bulldog Klemmen	142-145
Bunnell Handbohrapparat	547
Burford Rippensperrerr	366
Busch Nabelschnurscheren	41
Bushe Scharfe Löffel	519
C	
Caplan Septumschere	331
Carmalt Klemmen	120
Carmalt Pinzetten	104
Caroll Goniometer	4
Carotis Klemmen	145
Carpenter Dissektoren	305
Caspar Fadengabel	392
Caspar Rongeuere	479
Caspar Spreizer	293
Cast Verbandscheren	557
Castaneda Klemmen	146
Castaneda Rippensperrerr	364
Castroviejo Nadelhalter	253, 280
Castroviejo Scheren	59
Catlin Amputationsmesser	14
Cephalometer	4
Cerclage Draht	542
Cerclage -Instrumente	542
Cerny Hakenzange	443
Cerny Rektum Spekulas	414
Chaput Fasszangen	181
Charrière Amputationssäge	483, 484
Cheatle Sterilisierzangen	571
Chevalier Rippensperrerr	368
Chirurgische Pinzetten	92-98
Chirurgische Scheren	34-56, 71-80
Church Scheren	55
Cilien- und Splitter pinzetten	103-104
Cinelli Osteotome	326
Citelli Stanzen	469
Citelli-Beyer Stanzen	469
Classon Schere	55
Cleveland Hohlmeißelzangen	529
Cleveland Knochensplitterzangen	534
Cloward Wundsperrerr	294-296
Coakley Kieferhöhlenküretten	328
Coakley Trokar	27
Collier Nadelhalter	250
Collin Bauchdeckenhalter	234-236
Collin Beckenzirkel	453
Collin Dynamometer	4
Collin Fasszangen	177, 178
Collin Hammer	487
Collin Nabelschnurklemme	455
Collin Scheidenspekula	427
Collin Uterusfasszange	444
Collin Wundhaken	207, 209
Collin Wundklammerzangen	262
Collin Zungenzangen	303
Columella Pinzette	327
Conchotome	476
Converse Doppelhaken	327
Converse Plastikmesser	321
Cooley Atriumhaken	389
Cooley Dilatator	384
Cooley Gefäßdilatatoren	383
Cooley Klemmen	168-172
Cooley Klingenhalter	390
Cooley Pinzetten	100
Cooley Rippensperrerr	363, 372
Cooley Saugrohre	32
Cooley-De Bakey Klemmen	165
Cooper Unterbindungsnadeln	256
Cordes Zangenaufsätze	312
Coronar Scheren	56
Corwig-Hegar Drahtzange	543
Coryllos Hohlmeißelzangen	533
Coryllos Wundhaken	196
Cottle Elevatorien	323
Cottle Fixierpinzette	327
Cottle Hammer	486
Cottle Knochensplitterzangen	534
Cottle Knorpelinstrument	327
Cottle Meißel	492
Cottle Nasenflügelhaken	327, 328
Cottle Nasenspekula	318
Cottle Osteotome	325
Cottle Plastikmesser	321
Cottle Raspatorium	502
Cottle Schere	49, 79
Cottle-Walsham Septumzangen	330
Crafoord Klemmen	130
Crafoord Schere	40
Craig Septumzangen	329
Credo Hornhautheber	570
Crile Klemmen	121, 122, 126
Crile Wundhaken	209, 216
Crile-Murray Nadelhalter	249
Crile-Wood Nadelhalter	249, 268
Crutchfield Schädelhalter	286
Cusco Scheidenspekula	427
Cushing Flachbohrer	547
Cushing Häkchen	216, 220, 221, 222
Cushing Hirnspatel	283
Cushing Nervhaken	291
Cushing Pinzetten	90, 95, 112
Cushing Raspatorien	506
Cushing Rongeuere	478
Cushing Stanzen	474
Cushing Wundhaken	223
Cushing-Brown Pinzette	97
Cushing-Landolt Spreizer	296
Cuzzi Abortuslöffel	457
D	
Dahlgren Schädelzangen	287
Dale Klemme	163, 164
Dandy Klemmen	122, 126
Dandy Nervhaken	291
Dandy Schere	55
Dardik Klemmen	172
Darm klemmen	401-412
Darms cheren	41
Dartigues Uterusfasszange	444
Daubenspeck Scharfe Löffel	519
Davidson Wundhaken	206
Davis Dissektor	387
Davis Sterilisierpinzetten	571
Davis-Boyle Mundsperrerr	301
Davis-Boyle Zungenspatel	302
Day Ohrhäkchen	341
De Bakey Gefäßdilatatoren	383
De Bakey Klemmen	140, 145-167
De Bakey Nadelhalter	267
De Bakey Pinzetten	99-100, 114
De Bakey Rippensperrerr	370, 371
De Bakey Scheren	57, 82
De Martel Einführungsinstrument	288
De Martel-Wolfson Klemme	410
De Vilbiss Schädelzangen	287
Dean Scheren	49, 79

Deaver Scheren	36
Deaver Wundhaken	213, 214
Dejardins Gallenkanalsonden	421
Dejardins Gallensteinlöffel	422
Dejerine Perkussionshämmer	2
Demel Drahtspannzange	542
Demel Drahtumführungsinstr.	542
Denhardt Mundsperrerr	300
Dennis-Brown Sperrerr	241
Deponetten	581
Derff Nadelhalter	250, 270
Dermatome	20
Derra Klemmen	150, 170
Deschamps Unterbindungsnadeln	257, 258
Desjardins Klemme	138, 424
Desmarres Häkchen	424, 220
Dieffenbach Klemmen	143
Dieter Ohrzängchen	349, 350
Diethrich Klemmen	143, 166
Diethrich Nadelhalter	279
Dilatationsbougies	464
Dingmann Knochenhaltezaugen	522
Dingmann Mundsperrerr	301
Dingmann Zungenspatel	302
Dissektoren	288, 305, 352, 385, 387, 393
Diszisionsmesser	351
Dittel Dilatationsbougies	464
Dixon-Lovelace Klemme	121, 126
Dockhorn Wundhaken	193
Dosen	573-576
Douglas Pinzette	103
Douglas Trokar	27
Doyen Darmklemmen	401, 403
Doyen Fasszangen	175
Doyen Hämmer	487
Doyen Hohlsonde	23
Doyen Myom-Heber	444
Doyen Scheidenspekula	432
Doyen Scheren	37
Doyen Wundhaken	199, 201
Doyen-Jansen Mundsperrerr	300
Draht für Cerclage	542
Drahtbiegezüngchen	348
Drähte, Kirschner	552
Drahtextension	541-547
Drahtsägen	484
Drahtscheren	67, 83
Drahtschneidezangen	545, 546
Drahtspender	552
Drahtzangen	543-546
Dubois Scheren	40
Duehrssen Pinzette	97
Duke Trokar	27
Duplay Hakenzange	440
Duplex Stethoskope	3
Dupuy-Weiss Gaumennadel	308
Dura Dissektoren	288, 289, 385, 387
Dura Messer	19, 290
Duval Fasszangen	177, 178
Duval Pinzette	91
Dynamometer	4
E	
Eastman Wundhaken	205
Eaton Wundsperrerr	232
Echlin Hohlmeißelzangen	531
Einführungsinstrument	288
Eiselsberg Schere	66
Elektrische Gipssägen	562
Elevatorien	508, 509
Endospekula	435
Engel Gipssäge	561
Eppendorf Biopsiezange	450
Ersatzklingen	309
Ersatzschlingen	307
Ersatzschneiden	546
Esmarch Gipsmesser	561
Esmarch Verbandscheren	557
Eves Tonsillenschnürer	306
Explorationshäkchen	395
Extensions-Bügel	541
F	
Fadenfänger	261, 388
Fadenführungszangen	461
Fadengabeln	261
Farabeuf Knochenhaltezaugen	523
Farabeuf Raspatorien	504
Farabeuf Wundhaken	208
Farabeuf-Collin Raspatorien	504
Farrell Watteträger	24
Faßpinzetten	304
Faure Biopsiezangen	448
Faure Klemmen	136
Favaloro Schere	56
Fehland Anastomosenklemme	412
Feilchenfeld Pinzetten	104
Feilen	513-516, 569, 570
Feine Chirurgische Scheren	51-54, 81
Feine Häkchen	216-222
Ferguson Scheidenspekula	429
Ferguson Knochenhaltezaunge	523
Ferguson Saugrohre	30
Ferguson Schere	37
Ferris-Smith Pinzetten	96
Ferris-Smith-Cushing Stanzen	474
Ferris-Smith-Kerrison Stanzen	471-473
Ferrozell Hämmer	486-489
Fingernagel-Bohrer	570
Fingerringssägen	485
Finocchio Nadelhalter	252, 272
Finocchio Klemmen	137
Finocchio Rippensperrerr	363, 364, 369
Finsen Wundsperrerr	224
Fisch Häkchen	352
Fischschwanz Osteotom	492
Fisher Tonsillennmesser	306
Fistelmesser	17
Fixierscheiben	541
Flachbohrer	547
Flachzangen	543-546
Fomon Hauthäkchen	328
Fomon Knorpelritzmesser	320
Fomon Osteotome	326
Fomon Raspeln	513
Fomon Schere	47, 49-50, 79
Förster Fasszangen	176, 177
Fowler Tonsillennmesser	18
Fox Lupusschaber	21
Fränkel Kehlkopfzange	311
Fränkel Zangenaufsätze	312
Franz Bauchdeckenrahmen	243
Fräser	547
Frazier Dissektor	289
Frazier Nervhaken	291
Frazier Saugrohre	30
Freer Elevatorien	321
Freer Flachmeißel	490
Freer Gefäßspatel	386
Freer Häkchen	222
Freer Meißel	324

Freer Muskosamesser	320
Freer Raspatorien	321
Fremdkörperinstrumente	342
Frenzel Zungenspatel	299
Friedmann Hohlmeißelzangen	528
Friedmann Vulva Spreizer	435
Fritsch Wundhaken	199
Frosch Knochenhaltezange	523
Frykholm Hohlmeißelzange	532
Fuchs Klemme	121
Führungshohlsonden	259-261
Fuller Einführungsinstrument	349
Fußpflegeinstrumente	567-571

G	
Gabelschlüssel	541
Galeahaken	284
Gallaher Raspeln	513
Gallenkanalsonden	421
Gallensteinlöffel	422
Gallensteinzangen	424
Gardner Knochensplitterzangen	534
Gast Zungenspatel	302
Gaumenhaken	308
Gaumennadel	308
Geburtshilfe Instrumente	454, 455
Geburtszangen	454
Gefäß Instrumente	380-397
Gefäßdilatoren	383, 384, 391
Gefäßscheren	55-58
Gefäßspatel	386
Gefäßspreizer	391
Geissendörfer Klemmen	128
Gelhorn Biopsiezange	449
Gelpi-Loktite Wundsperrerr	229
Gelpi-Seiletz Wundsperrerr	229
Gemini Klemmen	129, 130
Gerald Pinzetten	90, 95, 102, 113
Gerald-Brown Pinzette	97
Gerlach Mikro-Häkchen	353
Gerster Knochenhalteklammer	527
Gewebefasszangen	175-181
Gewebekralle	392
Gibbon Rippenkontraktor	374
Giertz Rippenschere	362
Gillies Häkchen	222
Gillies Nadelhalter	252, 273
Gillies Pinzetten	88, 94, 113
Gil-Vernet Häkchen	221
Gipsabreißzange	561
Gipsinstrumente	555 — 562
Gipsmesser	561
Gipssägen	561, 562
Gipsscheren	558 — 560
Gipsspreizer	560
Glegg Polypenschnürer	345
Glover Klemmen	142, 155
Gluck Rippenschere	359
Goelet Wundhaken	209
Goldmann-Fox Scheren	52, 80
Goniometer	4
Good-Schwekendieck Scheren	49
Gorney Scheren	54
Gosset Bauchdeckenhalter	238
Gourdet Uteruslöffel	451
Graefe Häkchen	216, 217
Graefe Hautfasspinzette	327
Graefe Scheren	54
Graham Nervhaken	291
Grave Scheidenspekula	428

Gray Klemmen	137
Green-Armytage Klemmzange	455
Gregory Klemmen	163
Gregory-Soft Klemmen	145
Greven Drahtbiegezügchen	348
Griff zu Kehlkopfspiegel	310
Gross Fremdkörperinstrument	341
Gross-Maier Tupferzangen	173
Grünwald Pinzetten	102
Gummibirne	337, 338
Guyon Klemmen	139, 140
Guyon Metall Bougies	463
Gynäkologische Instrumente	426-457
Gynäkologische Klemmen	134-136
Gynäkologische Scheren	38-42, 71-74

H	
Haeney Klemmen	135
Haight Rippensperrerr	367
Hajek Nasenzange	476
Hakenzangen	440-443
Halle Duramesser	19, 290
Halle Gefäßspatel	386
Halle Scharfe Löffel	519
Halsey Nadelhalter	250, 269
Halsted-Mosquito Klemmen	119, 123, 126, 127
Hämmer	486-489
Hämorrhoidal Fasszange	417
Hämorrhoidal Ligator	417
Handbohrapparate	547
Handbohrfutter	542
Hank Uterusdilatoren	438
Harken Klemmen	167
Harrington Wundhaken	203
Hartmann Darmklemmen	402
Hartmann Hohlmeißelzangen	529
Hartmann Nasenzangen	476
Hartmann Ohrhäkchen	341
Hartmann Ohrkatheter	337
Hartmann Ohrpolypenzangen	343
Hartmann Ohrspekula	339
Hartmann Polypenzängchen	342
Hartmann Polypenzangen	319
Hartmann Stimmgabeln	335, 336
Hartmann Wundhaken	207
Hartmann Zungenspatel	299
Hartmann-Halle Nasenspekula	316
Harvey Schere	67
Hautstanzen	21
Hauttrephine	21
Heaney Nadelhalter	250, 271
Heath Hammer	487
Heermann Hammer	355
Heermann Handgriff	363
Heermann Hohlmeißel	355
Hegar Nadelhalter	249, 266, 277
Hegar Uterusdilatoren	436, 437
Hegar-Baumgartner Nadelhalter	249, 269
Hegar-Vascular Nadelhalter	277
Hegemann-Diethrich Scheren	58
Hegenbarth Pinzetten	262
Heifetz Hirnspatel	283
Heifetz Pinzetten	108
Heiss Klemmen	119
Heister Mundsperrerr	299
Henke Dissektoren	305
Henley Wundsperrerr	227
Henning Gipsspreizer	575
Herrick Klemme	140
Herz-Gefäß Instrumente	380-397

Heymann Polypenzange	319
Heymann Schere	50
Heymann Septumzangen	329
Hibbs Flachmeißel	495
Hibbs Hohlmeißel	496
Hirnmesser	16
Hirnspatel	283
HNO-Instrumente	298-355
Hoer Dissektoren	289
Hoer Raspatorien	506
Hohlmeißel	491-501
Hohlmeißelzangen	528-533
Hohlsonden	23
Hohmann Knochenhebel	510, 511
Hoke Flachmeißel	495
Holzheimer Wundsperrerr	224
Hopkins Gipsmesser	561
Hornhauthobel	570
Horsley Nervwurzelhaken	290
Hösel Nadelhalter	275
Hösel Wundhaken	202
House Mikro-Nadeln	353
House Scharfe Löffel	355
House-Dieter Ohrzängchen	349
Huber Universalgriff	312
Hudson Fräser	547
Hudson Handbohrapparat	547
Hunt Pinzetten	107, 109
Hunter Pinzetten	104
Hurd Dissektoren	305
Hurd Gaumennadel	308
Hysterektomie Klemmen	135
Hysterektomie Scheren	74
I	
Impfplanzette	5
Inge Wirbelkörperpreizer	296
Iowa Hakenzange	442
Iris Scheren	54, 81
Israel Wundhaken	190
Iterson Trachealhäkchen	313
Ives-Fansler Anuskop	415
J	
Jackson Trachealhäkchen	313
Jacobs Hakenzange	443
Jacobson Fadengabel	392
Jacobson Gefäßmesser	397
Jacobson Knopfsonden	391
Jameson Nadelhalter	251
Janet Spritzen	29
Jansen Hohlmeißelzangen	529, 531
Jansen Pinzetten	101
Jansen Scharfer Löffel	340
Jansen Septumzangen	331
Jansen Wundsperrerr	224
Javid Klemmen	164
Jennings Mundsperrerr	300
Jobson-Horne Watteträger	24
Johns-Hopkins Klemmen	138, 143
Jones Tuchklemmen	183
Joseph Elevatorien	323
Joseph Häkchen	222
Joseph Nasensäge	326
Joseph Plastikmesser	320, 321
Joseph Raspatorium	502
Joseph Raspeln	513
Joseph Scheren	51, 80
Judd-Allis Fasszangen	181
Jurasz Kehlkopfzange	311
K	
Kabierske Pulverbläser	338
Kahler Zangenaufsatz	312
Kallmorgen Scheidenspekula	431
Kane Nabelschnurklemme	455
Kanülen	28
Kapselasszangen	461
Kathetereinführinstrument	465
Kathetereinführzangen	461
Katsch Komedoneninstrument	22
Kehlkopfinstrumente	310-315
Kehlkopfspiegel	310
Kelly Anuskope	415
Kelly Fasszangen	175
Kelly Klemmen	122, 133
Kelly Scheren	51, 80
Kelly Wundhaken	201
Kelly-Rankin Klemmen	121
Kern-Lane Knochenhalte-zangen	524
Kerrison Stanzen	470-473
Kervorkian Absaugkürette	445
Kervorkian Biopsiezange	450
Key Knochensplitterzangen	536
Keyes Hautstanze	21
Killian Elevatorien	322
Killian Hohlmeißel	324
Killian Nasenspekula	317
Killian Raspatorien	502
Killian Septumschere	331
Kilner Häkchen	222
Kilner Nadelhalter	270
Kilner Nasenflügelhaken	327
Kilner Scheren	48, 78
Kilner-Doughty Mundsperrerr	301
Kirschner Bauchdeckenhalter	242
Kirschner Drähte	552, 553
Kirschner Extensions-Bügel	541
Kirschner Führungssonden	259, 260
Kirschnerdraht-Spender	552
Klammernblock	284
Klapp Häkchen	218
Kleinert-Kutz Sehnenzange	540
Klemmen	118-184, 327
Klingenbrecher	11, 390
Klingenhalter	11, 390
Klinkenbergh-Loth Schere	55
Knochenbohrer	485
Knochenchirurgie	468-547
Knochenhalte-zangen	521-527
Knochenhebel	508-512
Knochenscheren	359-362
Knochensplitterzangen	534-536
Knopfsonden	23, 391
Knorpelasszange	537
Knorpelmesser	15
Knowles Verbandscheren	556
Knüpfpinzetten	105, 106
Kocher Darmklemmen	401, 402, 404, 405
Kocher Klemmen	124
Kocher Sonden	314
Kocher Wundhaken	188, 193, 194, 198, 200, 221
Koerte Bauchspatel	212
Koerte Wundhaken	190
Kogan Endospekula	435
Kölner Kopfhautklammern	284
Komedoneninstrumente	22
Komprimeter	481
König Elevatorien	508
König Führungssonden	260
König Häkchen	220
König Raspatorium	501

Koos Gefäßmesser	397	Leriche Klemme	122, 126
Kopfhautklammern	284	Lewin Knochenhaltezange	521
Kopfschneider	545	Lewis Raspeln	513
Kornzangen	173, 174	Lexer Meißel	499-501
Krampfaderbesteck	381	Lexer Scheren	46, 77
Kraus Gefäßmesser	397	Lexer-Mini Meißel	499
Krause Polypenschnürer	320	Lichtenberg Nadelhalter	275
Krause Trokar	27	Lichtwitz Trokar	26
Krause Zangenaufsätze	312	Ligaturscheren	66, 67, 83
Krause-Voss Polypenschnürer	320	Lippenhalter	303
Krayenbühl Nervhäkchen	392	Lister Sinus Klemmen	173
Kressner Septumzangen	330	Lister Verbandschere	556, 557
Kristeller Scheidenspekula	429-431	Liston Amputationsmesser	14
Kronecker Unterbindungsnadeln	256	Liston Knochensplitterzangen	534-536
Krönlein Klemme	123	Littauer Pinzette	103
Kümmel Bauchspatel	211	Littauer Polypenzängchen	342
Kümmel Wundhaken	199	Littauer Polypenzange	319
Küretten	352	Littauer Scheren	66
L		Littler Scheren	53
La Force Tonsillotome	309	Lockhart-Mummery Sonden	24
La Grange Scheren	54	Locklin Scheren	56, 82
Laborde Tracheal Dilator	313	Lockwood Fasszangen	179
Lahey Hakenzange	443	Logan Wundsperrerr	224
Lahey Klemmen	138	Lorenz Verbandschere	556
Lahey Kropffasszangen	314	Lorna Tuchklemmen	183
Lambert-Kay Klemmen	164	Loute Drahtspanner	542
Lambotte Knochenhaltezangen	526	Love Nervwurzelhaken	289
Lambotte Meißel	492, 494	Love-Grünwald Rongeure	478
Lambotte Raspatorien	504	Lovelace Fasszangen	178
Laminektomie Spreizer	292-296	Lovelance Lungenfasszange	376
Laminektomie Zangen	478-480	Lower Klemme	138
Landau Scheidenspekula	433	Lowmann Knochenhalteklammern	527
Landau Trokar	27	Lubet-Barbon Tampozange	319
Landold Klingenthaler	390	Luc Septumzangen	329
Landolt Rongeure	480	Lucae Häkchen	216
Landolt Scheren	50	Lucae Hämmer	487
Landolt Spreizer	296	Lucae Ohrhäkchen	341
Lane Magenklammern	408	Lucae Parazentesenadeln	344
Lane Pinzetten	96	Lucae Pinzetten	101
Lane Tuchklemmen	183	Lucae Stimmgabeln	335, 336
Lange Fremdkörperhaken	328	Luer Hohlmeißelzangen	528, 530, 532, 533
Lange Verbandscheren	556	Luer Trachealhäkchen	313
Lange Zangenaufsatz	312	Luer Wundhaken	209
Langenbeck Amputationsmesser	14, 482	Luer-Friedmann Hohlmeißelz	528
Langenbeck Amputationssäge	484	Luer-Koerte Gallensteinlöffel	422
Langenbeck Elevatorien	508	Luer-Stille Hohlmeißelzange	532, 533
Langenbeck Knochenhaltezange	523	Luftdusche	337
Langenbeck Nadelhalter	276, 279	Lukens Trachealhäkchen	314
Langenbeck Ohrschlinge	340	Lungen Instrumente	358-377
Langenbeck Raspatorien	504, 506	Lungenspatel	375
Langenbeck Skalpelle	15, 482	Luniatschek Tamponstopfer	308
Langenbeck Wundhaken	191, 192, 193, 208, 221	Lupusschaber	21
Lanzettmesser	351	M	
Lappenmesser	351	Magen-/Darm Nähapparat	413
Laryngoskope	78	Magen-Darm Instrumente	400-418
Lawrence Klemme	129	Magill Kathetereinführzangen	461
Lazar Pinzetten	105	Maltz Raspel	513, 514
Leber-Galle-Niere Instrumente	420-424	Markwalder Hohlmeißelzange	533
Lebsche Sternummeißel	360	Marquardt Hohlmeißelzange	531
Lees Klemme	155, 160	Marschik Fasspinzette	304
Legueu Blasenspatel	462	Martel Fasszangen	181
Leksell Hohlmeißelzangen	532	Martin Beckenzirkel	453
Leland Klemmen	157	Martin Meniskusfaßzange	537
Lempert Elevatorien	345	Martin Uterussonde	439
Lempert Hohlmeißelzangen	529	Martin Wundhaken	206
Lempert Polypenschnürer	345	Martin-Langenbeck Elevatorien	509
Lempert Raspatorien	345	Masing Nadelhalter	269
Lempert Scharfe Löffel	518	Massing Elevatorium	323
Lerche Pinzette	98	Massing Nasenmeißel	326
Leriche Bauchspatel	211	Massing Wundhäkchen	328

Masson Nadelhalter	251, 272
Mast darm-Rektum Spekulas	414, 415
Masting Kropffasszange	314
Mathieu Fremdkörperzangen	462
Mathieu Mastdarm Spekulas	415
Mathieu Nadelhalter	252, 274, 279
Mathieu Wundhaken	208
Mayfield Hohlmeißelzange	531
Mayo Scheren	42, 43, 73, 77, 83
Mayo-Blake Gallensteinzangen	424
Mayo-Harrington Scheren	42, 73
Mayo-Hegar Nadelhalter	248, 266
Mayo-Lexer Scheren	77
Mayo-Noble Scheren	43
Mayo-Robson Daemklemmen	406, 407
Mayo-Russ , Modell Pinzette	91
Mayo-Stille Scheren	43, 74
Mc Gee Drahtbiegezügchen	348, 350
Mc Gee Ohrzängchen	347
Mc Ginvey Fasszange	417
Mc Indoe Knochensplitterzangen	535
Mc Indoe Pinzetten	88, 94, 112
Mc Indoe Schere	49
Mc Intosh Laryngoskope	7, 8
Mc Ivor Mundsperrerr	301
Mc Ivor Zungenspatel	302
Mc Kenty Elevatorien	323
Mc Kenzie Anlegezangen	285
Mc Kenzie Spiralbohrer	547
Mead Hammer	486
Mead Hohlmeißelzange	530
Meeker Klemme	130
Meißel	490-501
Menghini Kanülen	28
Meniskushaken	538, 539
Meniskusinstrumente	537-540
Meniskusmesser	537, 538
Mercedes Rippensperrerr	373
Messinstrumente	4, 5
Meßstäbe	5
Metall Bougies	463
Metall Katheter	465
Metzenbaum Scheren	44, 45, 75-78, 83
Metzenbaum-Lahey Schere	78
Metzenbaum-Thorek Scheren	78
Michel Kehlkopfspiegel	310
Michel Nahtbestecke	262
Michel Wundklammern	262
Michel Wundklammerzangen	262
Micro-Vascular Nadelhalter	278
Middendorpf Wundhaken	198
Middleton Septumzangen	331
Mikro Dissektoren	393, 394
Mikro Gefäßmesser	397
Mikro Hähchen	352-354, 392, 393
Mikro Löffel	401, 395
Mikro Nadelhalter	253, 254, 280
Mikro Nadeln	353
Mikro Ohrinstrumente	346-355
Mikro Ohrscheren	347
Mikro Ohrzängchen	346-350
Mikro Pinzetten	89, 94, 105-109
Mikro Raspatorium	394, 395
Mikro Scheren	59-65
Mikro-Knüpfpinzette	105, 106
Mikroskopier Pinzetten	86, 87
Mikulicz Klemmen	136
Mikulicz Wundhaken	195, 200
Milienmesser	21
Miller Feilen	516
Miller Laryngoskope	7, 8
Milligan Dissektor	288
Milligan Wundsperrerr	227
Millin Blasenhalsspreizer	462
Millin Blasensperrerr	233
Millin Fasszangen	461
Mills Scheren	56
Mini-Lambotte	492
Mixer Klemmen	131, 132, 137, 424
Mixer Scheren	37
Mixer-O'Shaugenessy Klemmen	138
Mock Kanülen	28
Modell USA Pinzette	87, 92
Modell Wien Nasenspekula	316
Moeltgen Goniometer	4
Moldenhauer Ohrhebel	341
Mollison Wundsperrerr	226
Molt Mundsperrerr	299
Monocorps Milienmesser	21
Morris Klemmen	161
Morse Rippensperrerr	365
Mosquito Klemmen	119, 123
Moynihan Klemmen	134
Muck Periostmesser	344
Mundbecher	575
Mundsperrerr	299-302
Museux Hakenzangen	442, 443
Myles Nasenzangen	476
Myommesser	17
Myrtenblattsonden	23
N	
Nabatoff Besteck	373
Nabelschnurscheren	41
Nadelhalter	245-254, 264-280
Nadelkasten	580-581
Nagel- und Fußpflege	564-571
Nagelausreißzangen	569
Nägele Geburtszangen	454
Nagelfeilen	569, 570
Nagelhautscheren	568, 569
Nagelscheren	568
Nagelzangen	581, 569
Nager Gaumenhaken	308
Nahtinstrumente	245-280
Nasen Osteotome	325, 326
Nasen Pinzetten	101-102
Nasenhäkchen	327, 328
Naseninstrumente	316-332
Nasenmeißel	324-326
Nasenoliven	337
Nasenscheren	49-50, 79
Nasenspekula	316-318
Nasenzangen	332, 475-477
Neff Meniskusmesser	537
Negus Bruststütze	303
Negus Klemmen	138
Neifert Nasenflügelretraktor	328
Nélaton Hohlsonde	23
Nelson Pinzette	97
Nelson Trokare	26
Nervhaken	291
Nervrädchen	4
Nervwurzelhaken	289, 290
Neurochirurgische Instrumente	282-296
Neurochirurgische Scheren	55-58
News Trachealhäkchen	314
Nierenschalen	574
Nierensteinzangen	423
Nierenstiel Klemmen	139, 140
Nippon Klemmen	118, 125
Northbent Schere	71

Noto Fasszangen	175
Novak Absaugküretten	445
Nussbaum Darmklemmen	406
O	
O'Sullivan-O'Connor Spekula	435
O'Sullivan-O'Connor Sperrer	241
Obwegeser Raspatorien	507
Obwegeser Wundhaken	192
Ochsner Klemmen	124, 166
Ochsner Trokar	27
Ochsner-Kocher Klemmen	124
Ohl Raspatorium	502
Ohr- und Nasenpinzetten	101-102
Ohrrelevatorien	345
Ohrhäkchen	341, 342
Ohr-Instrumente	334-355
Ohrkatheter	337
Ohrküretten	340, 341
Ohrpolypenschnürer	345
Ohrpolypenzangen	342, 343
Ohr Raspatorien	345
Ohrschlingen	341
Ohrspekula	339
Ohrspritzen	338
Oldberg Rongeuere	480
Olivecrona Dissektoren	288
Olivecrona Drahtsägen	484
Olivecrona Hirnspatel	283
Olivecrona Trigeminiussmesser	18
Olivecrona-Toennis Anlegezange	285
Ollier Wundhaken	190
Olson-Hegar Nadelhalter	252, 273
Organfasszangen	175-181
Organmesser	16
Osteotome	490-500
Oszillierende Gipssägen	562
Otoskopie Besteck	339
Overholt Klemmen	128, 131, 132
Overholt-Geissendörfer Klemmen	128
P	
Parametrium Scheren	42, 73
Parazentesenadeln	344
Parker Wundhaken	208
Parks Anal Spreizer	416
Partsch Flachmeißel	491
Partsch Hammer	488
Partsch Hohlmeißel	491
Passow Stößel	490
Patellazange	522
Paul Wundhaken	223
Payr Darm- u. Magenklemmen	409
Payr Führungssonden	261
Péan Klemmen	117, 118, 150
Pederson Scheidenspekula	428
Peet Splitterzangen	570
Penfield Dissektoren	385
Pennington Elevatorium	322
Pennington Fasszangen	178
Percy Amputations Retraktor	482
Periostmesser	344
Peritoneum- und Vaginal Klemmen	134-136
Perkussionshammer	2
Perthes Pfieme	485
Pestaloza Abortuslöffel	457
Petz Nähapparat	413
Pfieme	485
Phalangenmesser	14
Phaneuf Klemmen	134
Pierce Elevatorium	322

Pierce Trokar	27
Pinard Stethoskope	3
Pinzetten	86-114
Plester Häkchen	352
Plester Saugrohre	30
Plester Schaber	353
Plester Wundsperrer	226
Politzer Luftdusche	337
Politzer Parazentesenadeln	344
Polloson Wundhaken	204
Polypenschnürer	320
Polypenzangen	319
Poole Saugrohre	31
Potts-Smith Pinzetten	90, 95, 112
Potts-Smith Scheren	56, 57, 82
Pozzi Hakenzangen	440, 441
Präparierklemmen	128-130, 137, 138
Präparierscheren	43-48, 75-78
Pratt Hakenzange	443
Pratt Klemme	136
Price-Thomas Bronchusklemmen	377
Price-Thomas Klemmen	141
Prostatahaken	215
Providence-Hospital Klemmen	122
Pudentus Kanüle	28
Pulverbläser	338
Putti Raspeln	515
Q	
Quervain Elevatorium	508
Quire Fremdkörperinstrument	342
R	
Rabiner Perkussionshammer	2
Radolf Nagelausreißzange	569
Ragnell Scheren	45
Ragnell-Davis Häkchen	222
Ralk Splitterzangen	570
Rampléy Fasszangen	177
Randall Absaugküretten	445
Randall Nierensteinzangen	423
Raney Anlegezange	284
Rankin Klemmen	121, 126
Rasiermesser	20
Raspatorien	351, 352, 502-507
Raspeln	513-516
Recamier Uterusküretten	452
Rectum Biopsyzangen	418
Redon-Nadeln	25
Reichert Deckelhalter	311
Reill Knochenhaltezange	521
Reill Nadelhalter	254
Reill Scheren	63
Reiner Gipsmesser	561
Rektum Instrumente	400-418
Resano Kapselschere	43
Resano Rektumklemme	411
Reverdin Bauchspatel	210
Reverdin Nadeln	255
Ricard Bauchdeckenhalter	237
Richardson Wundhaken	205
Richter Scheren	37
Richter-Heath Klammerzange	262
Ringmesser	309
Ringstripper	382
Rippen Instrumente	359-374
Rippenkontraktoren	374
Rippenscheren	359-362
Rippensperrer	363-374
Ritter Stirnhöhrendilatatoren	24
Robb Dissektoren	387

Roberts Klemmen	132
Rochard Bauchdeckenhalter	244
Rochester Klemmen	117, 120
Roeder Tonsillenschnürer	306
Roeder Tuchklemmen	182
Roger Elevatorium	322
Rogers Klemmen	135
Rollermesser	351
Rongeurs	478-480
Rose Trachealhäkchen	313
Rose Wundhaken	209
Rosen Haken	352
Rosen Küretten	360
Rosen Lanzettmesser	351
Rosen Raspatorien	352
Rosen Rundschnittmesser	351
Rosenburg Zangenaufsatz	312
Roser-König Mundsperrler	300
Ross Wundhaken	223
Roux Wundhaken	207
Rubin Osteotome	325
Rubin Septumzange	331
Rudd Hämorrhoidal Ligator	417
Rumel Klemmen	131
Rumel-Belmont Tournique	388
Rundschnittmesser	351
Ruskin Hohlmeißelzangen	531, 532
Ruskin Knochensplitterzangen	535
Russ. Modell Pinzetten	91
Russel-Davis Zungenspatel	302
Rust Amputationssäge	483
Rydel-Seiffer Stimmgabeln	336
Ryder-Vascular Nadelhalter	278
S	
Saalfeld Komedoneninstrumente	22
Sachs Dissektoren	288
Sachs Nervhaken	291
Saenger Abortuszangen	457
Salenius Meniskusmesser	537
Salpingograph	447
Samii Pinzetten	108, 109
Samii Tumormesser	396
Santulli Klemme	145
Sanvenero Scheren	51
Sarot Klemmen	130
Sarot Nadelhalter	249, 268
Satinsky Klemmen	145, 165
Satinsky Schere	55
Satterlee Amputationssäge	484
Sauerbruch Hohlmeißelzangen	533
Sauerbruch Rippenschere	360, 361
Sauerbruch Wundhaken	196
Sauerbruch-Frey Rippenschere	361
Saugrohre	30-32
Scalp-Contour Wundsperrler	225
Schaber	353
Schädel Tuchklemmen	183
Schädelhalter	286
Schädelzangen	287
Schalen	573-576
Schamberg Komedoneninstrumente	22
Scharfe Löffel	517-520
Scharfes Häkchen	392
Scheidenspekula	427-434
Scheinmann Zangenaufsätze	312
Scherback Scheidenspekula	434
Scheren	33-69
Schieblehre	5
Schink Dermatome	20
Schlauchklemmen	184
Schleimhautmesser	351
Schlingen für Schnürer	345
Schmeden Nasenzangen	476
Schmid Gefäßspatel	386
Schmid Kanülen	28
Schmieden Führungssonden	260
Schmieden-Dick Nadeln	256
Schmieden-Taylor Schere	56
Schmidt Klemmen	120
Schoemaker-Loth Schere	67
Schoenborn Trachealhäkchen	314
Schröder Fistelmesser	17
Schröder Hakenzangen	440, 441
Schröder Uteruslöffel	451
Schubert Biopsiezangen	448
Schulze Salpingograph	447
Schumacher Biopsiezangen	449, 450
Schumacher Nabelschnurschere	41
Schumacher Zangenaufsatz	312
Schüsseln	573-576
Schwammfazzzangen	175, 176
Schweden Modell Pinzette	86
Schwesterngarnitur	570
Schwingmesser	324
Scoville Nervwurzelhaken	290
Scoville Scharfe Löffel	520
Scoville Spreizer	292
Scudder Darmklemmen	407
Sebileau Elevatorium	508
Sedillot Raspatorium	504
Segond Myommesser	17
Segond-Landau Klemmen	134
Sehnenfaßzange	539, 540
Sehnenflechklemmen	539
Seitenschneider	545, 546
Sellheim Geburtslöffel	455
Sellors Rippenkontraktor	374
Selman Pinzetten	91
Semb Bronchusklemmen	377
Semb Hohlmeißelzangen	533
Semb Knochenhalte-zangen	523
Semb Knochensplitterzangen	536
Semb Raspatorien	505
Semken Pinzetten	89, 94, 112, 113
Semm Scheidenspekula	427
Senn-Green Häkchen	221
Senning Nadelhalter	268
Senn-Miller Häkchen	221
Septuminstrumente	320-332
Septummesser	320
Septumscheren	331
Septumzangen	329, 330
Sequesterzangen	522
Sewall Elevatorium	323
Sexton Parazentesenadeln	344
Seyffert Scheidenspekula	428
Seziermesser	16
Shaaf Pinzette	103
Shambough Mikro-Nadeln	353
Shapleigh Ohrschlingen	340
Shea Scharfe Löffel	355
Sichelmesser	320, 351
Silver Dermatome	20
Simon Häkchen	220
Simon Scharfe Löffel	519
Simon Wundhaken	206
Simpson Geburtszangen	454
Sims Rektum Spekulat	414
Sims Scheidenspekula	429
Sims Scheren	38-39, 72

Sims Uterusdepressor	439	Subramanian Klemmen	147
Sims Uterusküretten	452	Sweet Anlegezangen	285
Sims Uterussonde	439	Synovektomie-Zangen	528
Sims-Siebold Scheren	39	Sypert Stanzen	473
Sinuskopie Trokar	26		
Skalpelle	12-19	T	
Skalpellogriffe	9,10	Tabb Schleimhautmesser	351
Skalpelloklingen	12	Takahashi Nasenzange	477
Skene Hakenzange	441	Tampon- und Polypenzangen	319
Sluder-Ballenger Tosillotom	308	Taylor Meniskushaken	539
Smillie Meniskushaken	538	Taylor Perkussionshämmer	2
Smillie Meniskusmesser	538	Taylor Pinzetten	52, 94, 95, 112
Smith Scheren	83	Taylor-Brown Pinzette	97
Smith Verbandschere	556	TC-Drahtschneidezangen	545
Smith-Petersen Flachmeißel	497	TC-Drahtzangen	543, 545
Smith-Petersen Hohlmeißel	497	TC-Nadelhalter	264-280
Smithwick Anlegezangen	285	TC-Pinzetten	116-114
Smithwick Nervhaken	291	TC-Scheren	69-83
Sommer Uterusfasszange	444	TC-Seitenschneider	545
Sonden	23, 24	Teale Hakenzange	442
Spannschlüssel	541, 542	Terrier Klemme	127
Spencer Scheren	66	Thoms-Gaylor Biopsiezange	449
Spencer-Wells Klemmen	118	Thorax Instrumente	358-377
Spezialfilter	581	Thorek Scheren	47, 78
Spiralbohrer	555, 563	Tieck-Halle Nasenspekula	316
Splitterpinzetten	110-111	Titan Bulldog Klemmen	144
Splitterzangen	583	Tobald Zungenspatel	299
Spongiosa Hohlmeißel	508-509	Toennis Dissektoren	387
Spratt Scharfe Löffel	526	Toennis Duramesser	19
Spritzen	34	Toennis Dura-Messer	290
Spurling Rongeuere	486	Toennis Klemmen	119, 125
Stacke Sonde	27	Toennis Nadelhalter	276
Stahldraht für Schnürer	353	Toennis Nervhaken	291
Standard Trokare	31	Toennis Scheren	48
Stanzen	477-482	Toennis-Adson Schere	48, 78
Stellbrink Hohlmeißelzangen	536	Tohoku Tuchklemmen	183
Sterilbehälter m. Kornzange	581	Tonsillen Kanülen	28
Sterilisationsprodukte	579-581	Tonsillenfasszangen	304
Sterilisierklammer	184	Tonsillennmesser	18, 306
Sterilisierpinzetten	571	Tonsillenscheren	49-50, 79
Sterilisierzangen	584	Tonsillenschnürer	306, 307
Sternberg Lippenhalter	303	Tonsillenzangen	476
Sternummeißel	360	Tonsillotom	307
Stethoskope	3	Tonsillotome	309
Stevens Scheren	53	Tosillinstrumente	304-309
Stieglitz Splitterzangen	570	Tourniquets	388
Stille Flachmeißel	493	Toynbee Ohrspekula	339
Stille Gipsscheren	560	Tracheal Instrumente	313-314
Stille Hohlmeißel	494	Trachealhäkchen	218, 219
Stille Hohlmeißelzange	532	Trélat Scheidenspekula	428
Stille Klemme	140	Trigeminusmesser	18
Stille Knochensplitterzangen	535	Troemner Perkussionshammer	2
Stille Osteotome	493	Trokare	26
Stille Pinzetten	87, 93	Tröltsch Pinzetten	101
Stille-Barraya Pinzette	97	Trousseau Tracheal Dilator	313
Stimmgabeln	335, 336	Troutman-Christ Klingenthaler	11
Stirnhöhledilatatoren	24	Tubbs Dilator	384
Stirnlampen	6	Tübingen Wundhaken	206
Stirnspiegel	6	Tübinger Modell Wundsperrler	227
Stockmann Penisklemme	462	Tuchklemmen	182, 183
Stone Pinzetten	98	Tuffier Fasszangen	181
Stößel	490	Tuffier Rippensperrler	367
Strabismus Scheren	47, 53	Tumormesser	396
Strabismuscheren	53	Tupfer- und Kornzangen	173-178
Strandell-Stille Häkchen	222	Turnbull Nagelzange	569
Stratte Nadelhalter	271	Tuttle Pinzette	91
Strauss Penisklemme	462	Tyding Tonsillenschnürer	307
Struck Rippensperrler	369		
Struempel Ohrpolypenzange	343	U	
Strully Scheren	55	Uhrmacher Pinzetten	104
Struycken Rongeuere	480	Ulrich Fistelmesser	17

Ulrich Knochenhaltezangen	532
Ulrich Tupferzangen	181
Universal Schere	74, 90
Universal Sterilisierzangen	584
Universal Trokar	31
Universal Verbandscheren	574
Universal Watteträger	28
Unna Komedoneninstrumente	26
Unna-Vidal Komedoneninstrument	26
Unterbindungsnadeln	263-266
Urologie Instrumente	467-473
Uterus Fasszangen	452
Uterusdepressoren	447
Uterusdilatoren	444-446
Uterusküretten	460
Uteruslöffel	459
Uterussonden	447
V	
Vaginal Klemmen	142-144
Van Buren Knochenhaltezange	531
Van Doren Biopsiezangen	457
Vannas Schere	66, 72
Vascular Nadelhalter	285-287
Veidenheimer Anastomosenklemme	420
Venenkanüle	33
Verband- und Gipsinstrumente	569 — 577
Verbandscheren	571 — 574
Verbrugge Knochenhaltezangen	533
Vernet Häkchen	228
Verres Kanülen	33
Vickers Hohlmeißelzange	536
Vidal Lupusschaber	25
Virchow Hirnmesser	20
Virchow Skalpell	19,20
Vise Pinzetten	112
Volkmann Scharfe Löffel	526, 528
Volkmann Wundhaken	195, 196
Vollmar Kanülen	33
Vollmar Ring Stripper	390
Voltolini Nasenspekula	324
Von Eicken Gaumennadel	316
Vorbohrer	294
Vulva Spreizer	443
W	
Wachenfeldt Pinzetten	269
Wagner Häkchen	223
Wagner Ohrhäkchen	350
Wagner Scheren	59, 60, 87
Waldmann Schere	47, 80
Walsham Septumzangen	338
Walter Doppelhaken	335
Walter Osteotome	333
Wangensteen Nadelhalter	258, 280
Wangensteen Pinzette	98, 120
Wartenberg Nervrädchen	5
Watson-Williams Nasenzangen	485
Watteträger	27-29
Waugh Pinzetten	99
Weber Klemmen	161
Webster Nadelhalter	257, 277
Wechselklingen	506
Wecker Schere	66
Weder Zungenspatel	307
Weil Nasenzange	485
Weil-Blakesley Nasenzangen	483
Weissbarth Scheidenspekula	442
Weitlaner Wundsperrerr	232-235
Wertheim Klemmen	142-144
Wertheim Scheren	46, 49
Westcott Scheren	71
White Tonsillenfasszangen	312
Whitehead Mundsperrerr	308
Wiener Modell Spekula	439
Wiener Raspeln	524
Wilde Pinzetten	108
Williger Elevatorien	516
Williger Hämmer	495
Williger Raspatorien	509
Williger Scharfe Löffel	525, 526
Winter Abortuszangen	464
Wirbelkörperspreizer	304
Wirbelsäulenspreizer	300-304
Wisconsin-Foregger Laryngoskope	8,9
Wolff Gipsabreißzange	576
Wolff Lupusschaber	25
Wullstein Ohrpolypenzange	351
Wullstein Saugrohr	35
Wullstein Wundsperrerr	233
Wundhaken	193-251, 300-304
Wundklammern	269
Wundklammerzangen	269
Wundnahtbestecke	269
Wundrandscheren	43
Wundsperrerr	231-239, 300-304
Y	
Yasargil Fadengabeln	400
Yasargil Fadengabeln	400
Yasargil Galeahaken	292
Yasargil Micro Löffel	403
Yasargil Mikro Raspatorium	403
Yasargil Nadelhalter	261
Yasargil Pinzetten	114-116
Yasargil Rongeuere	488
Yasargil Saugrohre	36
Yasargil Scheren	72
Yeoman Biopsyzange	426
Young Prostatahaken	222
Young Zungenzange	311
Young-Millin Nahtinstrumente	268
Z	
Zangenaufsätze	320
Zaufal Hohlmeißelzangen	539
Zaufal Ohrhebel	349
Zenker Klemmen	137
Zenker Wundhaken	201
Ziegler Duramesser	23
Zughaken	549
Zungendrücker	311
Zungenspatel	307-311
Zungenzangen	311
Zweifel Nadelhalter	284

A	
Abdominal Retractors	233-244
Abdominal Spatulas	210-212
Abraham Tonsil Knife	18, 306
Abscess Knife	19
Adenoid Curettes	309
Adenotomes	309
Adlerkreuz Forceps	96
Adson Drill Bit	547
Adson Forceps	88, 93, 98, 112-114, 120, 126
Adson Needle Holders	249
Adson Nerve Hooks	291
Adson Raspatories	502
Adson Retractors	228, 230, 231
Adson Suction Tube	30
Adson-Brown Forceps	98, 114
Agnew Myringotome	344
Air Bag	337
Alexander Biopsy Forceps	450
Alexander Chisel	491
Alexander Gouges	492
Alexander Raspatory	504, 505
Allis Grasping Forceps	180, 181
Allis-Adair Grasping Forceps	181
Allison Lung Spatulas	375
Allis-Thoms Grasping Forceps	180
Alm Retractors	224
Amniotome	441
Amputating Knives	14
Amputation	481-485
Anastomosis Clamps	410-412
Anderson-Adson Retractors	228
Anusscopes	415
Aortic Dilators	385
Applicators	352
Applying Forceps	284, 285
Arruga Needle Holders	252
Ash Septum Forceps	330
Aspirating Curettes	445, 446
Atraumatic Bulldog Clamps	142, 145
Atraumatic Forceps	99-100, 140, 146-172
Atrium Retractors	389
Aufricht Nasal Retractor	327
Aufricht Rasps	513
Austin Forceps	105
Autopsy Knives	16
Auvard Vaginal Specula	434
Ayre Myotome	17
B	
Babcock Grasping Forceps	179
Babinsky Percussion Hammer	2
Baby-Kocher Intestinal Clamps	401
Backhaus Towel Forceps	182
Bahnson Forceps	152
Bailey Rib Contractors	374
Bakes Gall Duct Dilators	421
Balfour Retractors	239, 240
Ballenger Holding Forceps	176
Ballenger Swivel Knives	324
Ballenger Tonsil Forceps	304
Bandage and Plaster Instruments	508-515
Bandage Scissors	509-512
Barraquer Forceps	103
Barraquer Needle Holders	254, 280
Barth Bone Curettes	340
Baumgartner Needle Holders	249, 269
Beacham Amniotome	441
Beck Forceps	150
Beckmann Adenoid Curettes	309
Beckmann Nasal Specula	317
Beckmann Retractors	231, 232
Beebe Scissors	67
Beer Forceps	103
Beeson Cast Retractor	513
Belucci Ear Scissors	348, 349
Bengolea Forceps	119, 125
Bergmann Bandage Scissors	511
Berliner Percussion Hammer	2
Bernhard Towel Forceps	182
Bertillon Cephalometer	4
Bethune Rib Shears	361
Betram Towel Forceps	183
Beuse Scissors	48
Beyer Bone Rongeurs	531
Biemer Vessel Spreader	391
Billeau Ear Loops	340
Biopsy Forceps	418, 448-450
Bircher Meniscus Knives	538
Bircher-Ganske Forceps	537
Birkett Forceps	132
Bishop Lip Retractor	303
Bladder Retractors	233
Blade Breakers	11, 390
Blade Holders	11, 390
Blake Embolus Grasping Forceps	388
Blake Gall Stone Forceps	424
Blakesley Nasal Forceps	332
Blohmke Tonsil Forceps	304
Blount Bone Levers	511
Blount Meniscus Retractors	539
Blumenthal Bone Rongeurs	529
Böhler Bone Rongeurs	530
Böhler Bone Cutting Forceps	535
Böhler Wire Traction Bow	541
Bone Curettes	517-520
OBone Cutting Forceps	534-536
Bone Holding Forceps	521-527
Bone Levers	508-512
Bone Rongeurs	528-533
Bone Scissors	359-362
Bone Surgery	468-547
Bonn Scissors	54
Bonney Forceps	96, 113, 114
Bose Trachea Retractors	313
Böttcher Scissors	49
Bowel Scissors	41
Bowls	573-576
Bowman Probes	23
Boxes	573-576
Boys-Allis Grasping Forceps	181
Bozemann Dressing Forceps	174
Bozemann Needle Holders	251, 271
Brain Clip Carrier	284
Brain Spatula	283
Brainbridge Forceps	121, 154
Brand Tendon Seizing Forceps	540
Braun Tenaculum Forceps	440, 443
Braun Uterine Depressor	439
Braun-Stadler Scissors	40
Breisky Vaginal Specula	433
Brian Knife	16
Brodie Director	22
Brom Retractors	223
Broncho-Esophagos Forceps	315
Bronchus Forceps	141
Brophy Forceps	90, 95
Brown Forceps	97
Brünings Laryngology Tips	312
Brünings Septum Forceps	329
Brünings Septum Knife	320

Brünings Tongue Depressor	299
Brünings Tonsil Knife	18, 306
Brünings Tonsil Snare	306
Brünings Tubes	312
Brunner Guiding Probes	259, 260
Brunner Rectal Clamps	411
Brunner Retractors	197
Brunner Rib Shears	362
Bruns Bone Curettes	517, 520
Bruns Plaster Scissors	558
Buck Ear Curettes	340
Buck Foreign Body Instrument	342
Buck Percussion Hammer	2
Buck Scissors	66
Buelau Trocar	26
Bulldog Clamps	142-145
Bunnell Hand Drill	547
Burford Rib Spreaders	366
Burrs	547
Busch Umbilical Scissors	41
Bushe Bone Curettes	519
C	
Caliper	5
Callus Plane	570
Caplan Septum Scissors	331
Cardiovascular Instruments	380-397
Carmalt Forceps	104
Carmalt Forceps	120
Caroll Goniometer	4
Carotis Clamps	145
Carpenter Dissectors	305
Cartilage Knives	15
Cartilage Seizing Forceps	537
Caspar Retractors	293
Caspar Rongeurs	479
Caspar Suture Pusher	392
Cast Bandage Scissors	557
Castaneda Forceps	146
Castaneda Rib Spreaders	557
Castroviejo Needle Holders	253, 280
Castroviejo Scissors	59
Catheter Forceps	461
Catheter Introducer	465
Catlin Amputating Knife	14
Cephalometer	4
Cerclage Instruments	542
Cerclage Wire	542
Cerny Rectal Speculas	414
Cerny Tenaculum Forceps	443
Chaput Grasping Forceps	181
Charrière Amputation Saws	483, 484
Cheatle Sterilizing Forceps	571
Chest Support	303
Chevalier Rib Spreader	368
Chisels	498-509
Church Scissors	62
Cilia and Splinter Forceps	103-104
Cinelli Osteotomes	326
Citelli Punches	469
Citelli-Beyer Punches	469
Classon Scissors	55
Cleveland Bone Cutting Forceps	534
Cleveland Bone Rongeurs	529
Cloward Wound Spreader	294-296
Coagley Antrum Curettes	328
Coakley Trocar	27
Collier Needle Holders	250
Collin Dynamometer	4
Collin Grasping Forceps	177, 178
Collin Holding Forceps	303
Collin Mallet	487
Collin Pelvimeter	453
Collin Retractors	207, 209, 234-236
Collin Suture Forceps	262
Collin Umbilical Cord Clamp	455
Collin Uterine Forceps	444
Collin Vaginal Specula	427
Columella Tissue Forceps	327
Comedone Extractors	22
Conchotomes	476
Conductor	288
Converse Nasal Retractor	327
Converse Septum Knife	321
Cooley Atrium Retractors	389
Cooley Dilator	384
Cooley Forceps	100, 168-172
Cooley Rib Spreaders	363, 372
Cooley Scalpel Holder	390
Cooley Suction Tubes	32
Cooley Vascular Dilators	383
Cooley-De Bakey Forceps	165
Cooper Ligature Needles	256
Cordes Laryngology Tips	312
Coronar Scissors	56
Corwig-Hegar Twisting Forceps	543
Coryllos Bone Rongeurs	533
Coryllos Retractors	196
Cottle Bone Crusher	327
Cottle Bone Cutting Forceps	534
Cottle Chisel	492
Cottle Elevators	323
Cottle Mallet	486
Cottle Nasal Retractors	327, 328
Cottle Nasal Specula	318
Cottle Osteotomes	325
Cottle Raspatory	502
Cottle Scissors	49, 79
Cottle Septum Knives	321
Cottle Tissue Forceps	327
Cottle-Walsham Septum Forceps	330
Cotton Applicators	23
Crafoord Forceps	130
Crafoord Scissors	40
Craig Septum Forceps	329
Credo Callus Plane	570
Crile Forceps	121, 122, 126
Crile Retractors	209, 216
Crile-Murray Needle Holders	249
Crile-Wood Needle Holder	249, 268
Crutchfield Skull Traction Tongs	286
Curettes	352
Cusco Vaginal Specula	427
Cushing Brain Spatula	283
Cushing Flat Drill	547
Cushing Forceps	90, 95, 112
Cushing Hooks	216, 220, 221, 222
Cushing Nerve Hook	291
Cushing Punches	474
Cushing Raspatories	506
Cushing Retractors	223
Cushing Rongeurs	478
Cushing-Brown Forceps	97
Cushing-Landolt Spreader	296
Cutter for wires and screws	546
Cuzzi Ovum Curettes	457
D	
Dahlgren Skull Punch	287
Dale Forceps	163, 164
Dandy Forceps	122, 126
Dandy Nerve Hook	291

Dandy Scissors	55
Dardik Forceps	172
Dartigues Uterine Forceps	444
Daubenspeck Bone Curettes	519
Davidson Retractors	206
Davis Dissector	387
Davis Sterilizing Forceps	376
Davis-Boyle Mouth Gag	301
Davis-Boyle Tongue Blades	302
Day Ear Hooks	341
De Bakey Forceps 99-100, 114, 140, 145-167	
De Bakey Needle Holders	267
De Bakey Rib Spreaders	370, 371
De Bakey Scissors	57, 82
De Bakey Vascular Dilators	383
De Martel Conductor	288
De Martel-Wolfson Clamps	410
De Vilbiss Skull Punch	287
Dean Scissors	49, 79
Deaver Retractors	213, 214
Deaver Scissors	36
Dejardins Gall Duct Dilators	421
Dejardins Gall Stone Scoops	422
Dejerine Percussion Hammers	2
Delicate Surgical Scissors	51-54, 81
Demel Wire Guide	542
Demel Wire Tightener Forceps	542
Denhardt Mouth Gag	300
Dennis-Brown Retractors	241
Deponettes	581
Derff Needle Holders	250, 270
Dermal Punch	21
Dermatomes	20
Derra Forceps	150, 170
Deschamps Ligature Needles	257, 258
Desjardins Forceps	138, 424
Desmarres Hooks	219, 220
Dieffenbach Clamps	135
Dieter Ear Forceps	349, 350
Diethrich Clamps	143, 166
Dietrich Needle Holders	279
Dilating Bougies	464
Dingmann Bone Holding Fcps.	522
Dingmann Mouth Gag	301
Dingmann Tongue Blades	302
Directors	23
Discision Knives	351
Dishes	573-576
Dissecting Forceps	128-130, 137, 138
Dissecting Scissors	43-48, 75-78
Dissectors	288, 305, 352, 385, 387, 393
Dittel Dilating Bougies	464
Dixon-Lovelace Forceps	121, 126
Dockhorn Retractors	193
Douglas Forceps	103
Douglas Trocar	27
Doyen Director	23
Doyen Holding Forceps	175
Doyen Intestinal Clamps	401, 403
Doyen Mallets	487
Doyen Myoma Screws	444
Doyen Retractors	199, 201
Doyen Scissors	37
Doyen Vaginal Specula	432
Doyen-Jansen Mouth Gag	300
Dressing and Sponge Forceps	173-178
Dressing Forceps	86-90
Dressing Forceps in jar	581
Drill Bits	547
Drill Points	286
Drilling Chuck	542
Dubois Scissors	40
Duehrssen Forceps	97
Duke Trocar	27
Duplay Tenaculum Forceps	440
Duplex Stethoscopes	3
Dupuy-Weiss Suture Needles	308
Dura Dissectors	288, 289, 385, 387
Dura Knife	19, 290
Duval Forceps	91
Duval Grasping Forceps	177, 178
Dynamometer	4
E	
Ear and Nose Forceps	101-102
Ear Catheters	337
Ear Curettes	340, 341
Ear Elevators	345
Ear Hooks	341, 342
Ear Instruments	334-355
Ear Loops	341
Ear Polypus Forceps	342, 343
Ear Rasparories	345
Ear Snares	345
Ear Specula	339
Ear Syringes	338
Eastman Retractors	205
Eaton Retractors	232
Echlin Bone Rongeurs	531
Eiselsberg Scissors	66
Elevators	508, 509
Endospecula	435
Engel Plaster Saw	561
ENT Instruments	298-355
Eppendorf Biopsy Forceps	450
Esmarch Bandage Scissors	557
Esmarch Plaster Knives	561
Eves Tonsil Snares	306
Exploration Hooks	395
F	
Farabeuf Bone Holding Forceps	523
Farabeuf Raspatories	504
Farabeuf Retractors	208
Farabeuf-Collin Raspatories	504
Farrell Cotton Applicators	24
Faure Biopsy Forceps	448
Faure Forceps	136
Favaloro Scissors	56
Fehland Anastomosis Clamps	412
Feilchenfeld Forceps	104
Ferguson Vaginal Specula	429
Fergusson Bone Holding Fcps.	523
Fergusson Scissors	37
Fergusson Suction Tubes	30
Ferris-Smith Forceps	96
Ferris-Smith-Cushing Punches	474
Ferris-Smith-Kerrison Punches	471-473
Ferrozell Mallets	486-489
Files	513-516, 569, 570
Filter, textile	581
Finger Nail Drill	570
Finger Ring Saws	485
Finochietto Forceps	137
Finochietto Rib Spreaders	363, 364, 369
Finsen Retractors	224
Fioncchietto Needle Holders	252, 272
Fisch Hooks	352
Fisher Tonsil Knife	306
Fishtail Ostoetome	492
Fistula Knives	17

Fixation Discs	541
Flap Knife	351
Flap Knives	351
Flat Drills	547
Flat Nose Pliers	543-546
Fomon Osteotomes	326
Fomon Rasps	513
Fomon Scissors	47, 49-50, 79
Fomon Septum Knife	320
Fomon Skin Hooks	328
Forceps	114
Forceps, Clamps, Clips	184, 327
Foreign Body Instruments	342
Förster Holding Forceps	176, 177
Fowler Tonsil Knife	18
Fox Lupus Scraper	21
Fränkel Laryngeal Forceps	311
Fränkel Laryngology Tips	312
Franz Retractor	243
Frazier Dissector	289
Frazier Nerve Hook	291
Frazier Suction Tubes	30
Freer Chisel	324, 490
Freer Elevatories	321
Freer Hooks	222
Freer Muscosa Knives	320
Freer Raspatories	321
Freer Vascular Spatula	386
Frenzel Tongue Depressor	299
Friedmann Bone Rongeurs	528
Friedmann Vaginal Spreader	435
Fritsch Retractors	199
Front Cutting Pliers	545
Frontal Sinus Bougies	24
Frosch Bone Holding Forceps	523
Frykholm Bone Rongeurs	532
Fuchsig Forceps	121
Fuller Introduction Instrument	349
G	
Galea Hooks	284
Gall Duct Dilators	421
Gall Stone Forceps	424
Gall Stone Scoops	422
Gallaher Rasps	513
Gardner Bone Cutting Forceps	534
Gast Tongue Blades	302
Geissendörfer Forceps	128
Gelhorn Biopsy Forceps	449
Gelpi-Loktite Retractors	229
Gelpi-Seiletz Retractors	229
Gemini Forceps	129, 130
Genito Urinary Instruments	460-465
Gerald Forceps	90, 95, 102, 113
Gerald-Brown Forceps	97
Gerlach Micro Hooks	345
Gerster Bone Holding Clamp	527
Gibbon Rib Contractor	374
Giertz Rib Shears	362
Gillies Forceps	88, 94, 113
Gillies Hooks	222
Gillies Needle Holders	252, 273
Gil-Vernet Hooks	221
Glegg Snare	345
Glover Clamps	142, 155
Gluck Rib Shear	359
Goelet Retractors	209
Goldmann-Fox Scissors	52, 80
Goniometer	4
Good-Schwekendieck Scissors	49
Gorney Scissors	47
Gosset Retractors	238
Gouges	491-501
Gourdet Uterine Scoops	451
Graefe Hooks	216, 217
Graefe Scissors	54
Graefe Tissue Forceps	327
Graham Nerve Hook	291
Grave Vaginal Specula	428
Gray Forceps	137
Green-Armytage Forceps	455
Gregory Forceps	163
Gregory-Soft Clamps	145
Greven Wire Forceps	348
Gross Foreign Body Instrument	341
Gross-Maier Dressing Forceps	173
Grünewald Forceps	102
Guiding Probes	259-261
Guyon Forceps	139, 140
Guyon Urethral Bougies	463
Gynaecology Forceps	134-136
Gynecological Scissors	38-42, 72-74
Gynecology Instruments	426-457
H	
Haemostatic Forceps	117-126
Haeney Forceps	135
Haight Rib Spreaders	367
Hajek Nasal Forceps	476
Halle Bone Curette	519
Halle Dura Knife	19, 290
Halle Vascular Spatula	386
Halsey Needle Holders	250, 269
Halsted-Mosquito Forceps	119, 123, 126, 127
Hand Drills	547
Handles for Laryngeal Mirrors	310
Hank Uterine Dilators	438
Harken Forceps	167
Harrington Retractors	203
Hartmann Bone Rongeurs	529
Hartmann Ear Catheter	337
Hartmann Ear Hook	341
Hartmann Ear Polypus Forceps	342
Hartmann Ear Polypus Forceps	343
Hartmann Ear Specula	339
Hartmann Intestinal Clamps	402
Hartmann Nasal Forceps	476
Hartmann Polypus Forceps	319
Hartmann Retractors	207
Hartmann Tongue Depressor	299
Hartmann Tuning Forks	335, 336
Hartmann-Halle Nasal Specula	316
Harvey Scissors	67
Head Lights	6
Head Mirrors	6
Heaney Needle Holders	250, 271
Heath Mallet	487
Heermann Gouges	355
Heermann Handle	355
Heermann Mallet	355
Hegar Needle Holders	249, 266, 277
Hegar Uterine Dilators	436, 437
Hegar-Vascular Needle Holders	277
Hegemann-Diethrich Scissors	58
Hegenbarth Suture Forceps	262
Heifetz Brain Spatula	283
Heifetz Forceps	108
Heiss Forceps	119
Heister Mouth Gag	299
Hemorrhoidal Grasping Forceps	417

Hemorrhoidal Ligator	417
Henke Dissectors	305
Henley Retractor	227
Henning Plaster Spreader	560
Herrick Forceps	140
Heymann Polypus Forceps	319
Heymann Scissors	50
Heymann Septum Forceps	329
Hibbs Chisel	495
Hibbs Gouges	496
High Precision Instrument	481
Hoer Dissectors	289
Hoer Raspatories	506
Hohmann Bone Levers	510, 511
Hoke Chisel	495
Holding Forceps	304
Holzheimer Retractors	224
Hooks, fine	216-222
Hopkins Plaster Knives	561
Horsley Nerve Root Retractor	290
Hösel Needle Holders	283
Hösel Retractors	275
House Bone Curettes	355
House Micro Needles	353
House-Dieter Ear Forceps	349
Huber Universal Handle	312
Hudson Burrs	547
Hudson Hand Drill	547
Hunt Forceps	107, 109
Hunter Forceps	104
Hurd Dissectors	305
Hurd Ligature Needles	308
Hypodermic Syringes	29
Hysterectomy Forceps	135
Hysterectomy Scissors	74
I	
Inge Lamina Spreader	296
Interchangeable Blades	498
Intestinal Clamps	401-412
Intestinal-/Stomach Suture Set	413
Iowa Tenaculum Forceps	442
Iris Scissors	54, 81
Israel Retractors	190
Iterson Trachea Retractors	313
Ives-Fansler Anuscope	415
J	
Jackson Trachea Retractor	313
Jacobs Tenaculum Forceps	443
Jacobson Probes	391
Jacobson Suture Pusher	392
Jacobson Vessel Knives	397
Jameson Needle Holders	251
Janet Hypodermic Syringes	29
Jansen Bone Curettes	340
Jansen Bone Rongeurs	529, 531
Jansen Forceps	101
Jansen Retractors	224
Jansen Septum Forceps	331
Javid Forceps	164
Jennings Mouth Gag	300
Jeweller Type Forceps	104
Jobson-Horne Cotton Applicator	24
Johns-Hopkins Forceps	138, 143
Jones Towel Forceps	183
Joseph Elevators	323
Joseph Hooks	222
Joseph Nasal Saws	326
Joseph Raspatory	502
Joseph Rasps	513
Joseph Scissors	51, 80
Joseph Septum Knives	320, 321
Judd-Allis Grasping Forceps	181
Jurasz Laryngeal Forceps	311
K	
Kabierske Powder Blower	338
Kahler Laryngology Tip	312
Kallmorgen Vaginal Specula	431
Kane Umbilical Cord Clamp	455
Katsch Comedone Extractor	22
Kelly Anusopes	415
Kelly Forceps	122, 133
Kelly Grasping Forceps	175
Kelly Retractors	201
Kelly Scissors	51, 80
Kelly-Rankin Forceps	121
Kern-Lane Bone Holding Fcps.	524
Kerrison Punches	470-473
Kervorkian Aspirating Curette	445
Kervorkian Biopsy Forceps	450
Key Bone Cutting Forceps	536
Keyes Dermal Punch	21
Kidney Bowls	574
Kidney Pedicle Forceps	139, 140
Kidney Stone Forceps	423
Killian Elevators	322
Killian Gouges	324
Killian Nasal Specula	317
Killian Raspatories	502
Killian Septum Scissors	331
Kilner Hooks	222
Kilner Nasal Retractors	327
Kilner Needle Holders	270
Kilner Scissors	48, 78
Kilner-Doughty Mouth Gag	301
Kirschner Guiding Probes	259, 260
Kirschner Retractors	242
Kirschner Wire	552, 553
Kirschner Wire Traction Bow	541
Kirschner wires dispenser	552
Klapp Hooks	218
Kleinert-Kutz Tendon Forceps	540
Klinkenbergh-Loth Scissors	55
Knowles Bandage Scissors	556
Kocher Forceps	124
Kocher Intestinal Clamps	401, 402, 404, 405
Kocher Retractors	188, 193, 194, 198, 200, 221
Kocher Trachea Directors	314
Koerte Abdominal Spatulas	212
Koerte Retractors	190
Kogan Endospecula	435
Kölner Scalp Clips	284
König Elevators	508
König Guiding Probes	260
König Hooks	220
König Raspatory	501
Koos Vessel Knives	397
Kraus Vessel Knives	397
Krause Laryngology Tips	312
Krause Polypus Snares	320
Krause Trocar	27
Krause-Voss Polypus Snares	320
Krayenbühl Vessel Hook	392
Kressner Septum Forceps	330
Kristeller Vaginal Specula	429-431
Kronecker Ligature Needles	256
Krönlein Forceps	123
Kümmel Abdominal Spatulas	211
Kümmel Retractors	199

L	
La Force Adenotomes	309
La Grange Scissors	54
Laborde Trachea Dilator	313
Lahey Forceps	138
Lahey Seizing Forceps	314
Lahey Tenaculum Forceps	443
Lambert-Kay Forceps	164
Lambotte Bone Holding Forceps	526
Lambotte Chisel	492, 494
Lambotte Raspatories	504
Lamina Spreaders	296
Laminectomy Retractors	292-296
Laminectomy Rongeurs	478-480
Lancet Knives	351
Landau Trocar	27
Landau Vaginal Specula	433
Landolt Rongeurs	480
Landolt Scalpel Holder	390
Landolt Scissors	50
Landolt Spreader	296
Lane Forceps	96
Lane Stomach Clamps	408
Lane Towel Forceps	183
Lange Bandage Scissors	556
Lange Foreign Hook	328
Lange Laryngology Tip	312
Langenbeck Amputating Knife	14, 482
Langenbeck Amputation Saw	484
Langenbeck Bone Holding Fcps.	523
Langenbeck Ear Loop	340
Langenbeck Elevators	508
Langenbeck Needle Holders	276, 279
Langenbeck Raspatories	504, 506
Langenbeck Retractors	191, 192, 193, 208, 221
Langenbeck Scalpels	15, 482
Laryngeal Instruments	310-315
Laryngeal Mirrors	310
Laryngology Tips	312
Laryngoscopes	7.8
Lawrence Forceps	129
Lazar Forceps	105
Lebsche Sternum Chisel	360
Lees Forceps	155, 160
Legueu Bladder Spatula	462
Leksell Bone Rongeurs	532
Leland Forceps	157
Lempert Bone Curettes	518
Lempert Bone Rongeurs	529
Lempert Elevators	345
Lempert Raspatories	345
Lempert Snares	345
Lerche Forceps	98
Leriche Abdominal Spatulas	211
Leriche Forceps	122, 126
Lewin Bone Holding Forceps	521
Lewis Rasps	513
Lexer Chisel	499-501
Lexer Scissors	46, 77
Lexer-Mini Chisel	499
Lichtenberg Needle Holders	275
Lichtwitz Trocar	26
Ligature Adjusters	261
Ligature Carrying Forceps	461
Ligature Catcher	261
Ligature Needles	256-259
Ligature Scissors	66, 67, 83
Lip Retractor	303
Lister Bandage Scissors	556, 557
Lister Sinus Forceps	173
Liston Amputating Knife	14
Liston Bone Cutting Forceps	534-536
Littauer Ear Polypus Forceps	342
Littauer Forceps	103
Littauer Polypus Forceps	319
Littauer Scissors	66
Littler Scissors	53
Liver-Gall-Kidney Instruments	420-424
Lobe Grasping Forceps	461
Lockhart-Mummery Probes	24
Locklin Scissors	56, 82
Lockwood Grasping Forceps	179
Logan Retractors	224
Loops for Snares	345
Lorenz Bandage Scissors	556
Lorna Towel Forceps	183
Loute Wire Tightener	542
Love Nerve Root Retractors	289
Love-Grünwald Rongeurs	478
Lovelace Grasping Forceps	178
Lovelance Forceps	376
Lower Forceps	138
Lowmann Bone Holding Clamps	527
Lubet-Barbon Tampon Forceps	319
Luc Septum Forceps	329
Lucae Ear Hooks	341
Lucae Forceps	101
Lucae Hooks	216
Lucae Mallets	487
Lucae Myringotomes	344
Lucae Tuning Forks	335, 336
Luer Bone Rongeurs	528, 530, 532, 533
Luer Retractors	209
Luer Trachea Retractor	313
Luer-Friedmann Bone Rongeurs	528
Luer-Koerte Gall Stone Scoops	422
Luer-Stille Bone Rongeur	532, 533
Lukens Trachea Retractors	314
Lung Instruments	358-377
Lung Spatula	375
Luniatschek Tonsil Packers	308
Lupus Scraper	21
M	
Magill Catheter Forceps	461
Mallets	486-489
Maltz Rasp	513, 514
Markwalder Bone Rongeurs	533
Marquardt Bone Rongeurs	531
Marschik Tonsil Forceps	304
Martel Grasping Forceps	181
Martin Meniscus Forceps	537
Martin Pelvimeter	453
Martin Retractors	206
Martin Uterine Probes	439
Martin-Langenbeck Elevators	509
Masing Needle Holders	269
Massing Elevator	323
Massing Nasal Chisels	326
Massing Nasal Hooks	328
Masson Needle Holders	251, 272
Masting Seizin Forceps	314
Mathieu Foreign Body Forceps	462
Mathieu Needle Holders	252, 274, 279
Mathieu Rectal Specula	415
Mathieu Retractors	208
Mayfield Bone Rongeurs	531
Mayo Scissors	42, 43, 73, 77, 83
Mayo-Blake Gall Stone Forceps	424
Mayo-Harrington Scissors	42, 73
Mayo-Hegar Needle Holders	248, 266
Mayo-Lexer Scissors	77

Mayo-Noble Scissors	43
Mayo-Robson Intestinal Clamps	406, 407
Mayo-Russ. Model Forceps	91
Mayo-Stille Scissors	43, 74
Mc Gee Ear Forceps	347
Mc Gee Wire Forceps	348, 350
Mc Ginvey Grasping Forceps	417
Mc Indoe Bone Cutting Forceps	535
Mc Indoe Forceps	88, 94, 112
Mc Indoe Scissors	49
Mc Intosh Laryngoscopes	78
Mc Ivor Mouth Gag	301
Mc Ivor Tongue Blades	302
Mc Kenty Elevators	323
Mc Kenzie Applying Forceps	285
Mc Kenzie Drill Bit	547
Mead Bone Rongeurs	530
Mead Mallet	486
Measuring Instruments	4,5
Meeker Forceps	130
Menghini Needles	28
Meniscus Instruments	537-540
Meniscus Knives	537, 538
Meniscus Retractors	538, 539
Mercedes Rib Spreaders	373
Metal Catheters	465
Metal Cups	575
Metzenbaum Scissors	44, 45, 75-78, 83
Metzenbaum-Lahey Scissors	78
Metzenbaum-Thorek Scissors	78
Michel Laryngeal Mirrors	310
Michel Suture Forceps	262
Michel Suture Sets	262
Michel Wound Clips	262
Micro Dissectors	393, 394
Micro Ear Forceps	346-350
Micro Ear Instruments	346-355
Micro Ear Scissors	347
Micro Forceps	89, 94, 105-109
Micro Hooks	352-354, 392, 393
Micro Needle Holders	253, 254, 280
Micro Needles	353
Micro Raspatory	394, 395
Micro Scissors	59-65
Micro Scoops	393, 395
Micro Suture Tying Forceps	105, 106
Micro Vessel Knives	397
Microscopic Forceps	86, 87
Micro-Vascular Needle Holders	278
Middendorpf Retractors	198
Middleton Septum Forceps	331
Mikulicz Forceps	136
Mikulicz Retractors	195, 200
Milium Knife	21
Miller Files	516
Miller Laryngoscopes	78
Milligan Dissector	288
Milligan Retractors	227
Millin Bladder Neck Spreader	462
Millin Grasping Forceps	461
Millin Retractors	233
Mills Scissors	56
Mini-Osteotomes	492
Mixter Forceps	131, 132, 137, 424
Mixter Scissors	37
Mixter-O'Shaugenessy Forceps	138
Mock Needles	28
Model USA Forceps	87, 92
Modell Wien Nasal Specula	316
Moeltgen Goniometer	4
Moldenhauer Elevator	341
Mollison Retractors	226
Molt Mouth Gag	299
Monocorps Milium Knife	21
Morris Forceps	161
Morse Rib Spreaders	365
Mosquito Forceps	119, 123
Mouth Gags	299-302
Moynihan Forceps	134
Muck Periosteal Knife	344
Mukosa Knives	351
Museux Tenaculum Forceps	442, 443
Myles Nasal Forceps	476
Myotome	17
Myringotomes	344
Myrte Leaf Probes	23
N	
Nabatoff Vein Probe Set	381
Nägele Obstetrical Forceps	454
Nager Tonsil Retractor	308
Nail Care Instruments	467-571
Nail Care Products	467-571
Nail Cutters	568, 569
Nail Extracting Forceps	569
Nail Scissors	568, 569
Nasal Chisels	324-326
Nasal Forceps	332, 475-477
Nasal Hooks	327, 328
Nasal Instruments	316-332
Nasal Olives	337
Nasal Osteotomes	325, 326
Nasal Scissors	49-50, 79
Nasal Snare	320
Nasal Specula	316-318
Needle Case	580-581
Needle Holders	245-254, 264-280
Neff Meniscus Knives	537
Negus Chest Support	303
Negus Forceps	138
Neifert Nasal Retractor	328
Nélaton Director	23
Nelson Forceps	97
Nelson Trocars	26
Nerve Hooks	291
Nerve Root Retractors	289, 290
Neuro Surgery Scissors	55-58
Neurosurgery Instruments	282-296
News Trachea Retractor	314
Nippon Forceps	118, 125
Northbent Scissors	66
Nose Forceps	101-102
Noto Holding Forceps	175
Novak Aspirating Curettes	445
Nurses set	570
Nussbaum Intestinal Clamps	406
O	
O'Sullivan-O'Connor Retractors	241
Obstetrical Forceps	454
Obstetrics Instruments	454, 455
Obwegeser Raspatories	507
Obwegeser Retractors	192
Ochsner Forceps	124, 166
Ochsner Trocar	27
Ochsner-Kocher Forceps	124
Ohl Raspatory	502
Oldberg Rongeurs	480
Olivecrona Brain Spatula	283
Olivecrona Dissectors	288
Olivecrona Trigeminal Knife	18
Olivecrona Wire Saws	484

Olivecrona-Toennis Forceps	285	Prostatic Retractors	215
Ollier Retractors	190	Providence-Hospital Forceps	122
Olson-Hegar Needle Holders	252, 273	Pudendus Needle	28
Operating Scissors	34-56, 71-80	Punches	469-474
Organ Holding Forceps	175-181	Putti Rasps	515
Oscillating Plaster Saws	562		
Osteotomes	490-500	Q	
O'Sullivan-O'Connor Specula	435	Quervain Elevator	508
Otосcopy Set	339	Quire Foreign Body Instrument	342
Overholt Forceps	128, 131, 132		
Overholt-Geissendörfer Forceps	128	R	
Ovum Curettes	457	Rabiner Percussion Hammer	2
Ovum Forceps	456, 457	Radolf Nail Extracting Forceps	569
		Ragnell Scissors	48
P		Ragnell-Davis Hooks	222
Parametrium Scissors	42, 73	Ralk Splinter Forceps	570
Parker Retractors	208	Rampley Holding Forceps	177
Parks Rectal Spreader	416	Randall Aspirating Curettes	445
Partsch Chisel	491	Randall Kidney Stone Forceps	423
Partsch Gouges	491	Raney Forceps	284
Partsch Mallets	488	Rankin Forceps	121, 126
Passow Tamper	490	Raspatories	351, 352, 502-507
Patella Forceps	522	Rasps	513-516
Paul Retractors	223	Razor	20
Payr Guiding Probes	261	Recamier Uterine Curettes	452
Payr Intestinal and Stomach Clamps	409	Rectal Biopsy Forceps	418
Péan Forceps	117, 118, 150	Rectal Speculas	414, 415
Pederson Vaginal Specula	428	Rectal Spreader	416
Peet Splinter Forceps	570	Rectum Instruments	400-418
Pelvimeters	453	Redon Guide Needles	25
Penfield Dissectors	385	Reichert Epiglottis Retractor	311
Pennington Elevator	322	Reill Bone Holding Forceps	521
Pennington Grasping Forceps	178	Reill Needle Holders	254
Percussion Hammers	2	Reill Scissors	63
Percy Amputation Retractor	482	Reiner Plaster Knives	561
Periostal Knives	344	Replacement Edges	546
Peritoneum and Vaginal Forceps	134-136	Resano Cartilage Scissors	43
Perthes Riemers	485	Resano Rectal Clamps	411
Pestalozza Ovum Forceps	457	Retractors	186-244, 292-296
Petz Suture Set	413	Reverdin Abdominal Spatulas	210
Phalangeal Knife	14	Reverdin Needles	255
Phaneuf Forceps	134	Rib Contractors	374
Pierce Elevator	322	Rib Instruments	359-374
Pierce Trocar	27	Rib Shears	359-362
Pinard Stethoscopes	3	Rib Spreaders	363-374
Pinwheel	4	Ricard Retractors	237
Plaster Breakers	561	Richardson Retractors	205
Plaster Instruments	567-562	Richter Scissors	37
Plaster Knives	561	Richter-Heath Suture Forceps	262
Plaster Saws	561, 562	Riemers	493
Plaster Scissors	558-560	Ring Strippers	382
Plaster Spreader	560	Ritter Frontal Sinus Bougies	24
Plester Hooks	352	Robb Dissectors	387
Plester Retractors	226	Roberts Forceps	132
Plester Scaper	353	Rochard Retractors	244
Plester Suction Tubes	30	Rochester Forceps	117, 120
Politzer Air Bag	337	Roeder Tonsil Snare	306
Politzer Myringotomes	344	Roeder Towel Forceps	182
Polloson Retractors	204	Roger Elevator	322
Polypus Forceps	319	Rogers Forceps	135
Poole Suction Tubes	31	Roller Knives	351
Post Mortem Knives	16	Rongeurs	478-480
Potts-Smith Forceps	90, 95, 112	Rose Retractors	209
Potts-Smith Scissors	56, 57, 82	Rose Trachea Retractor	313
Powder Blower	338	Rosen Curettes	352
Pozzi Tenaculum Forceps	440, 441	Rosen Flap Knives	351
Pratt Forceps	136	Rosen Hooks	352
Pratt Tenaculum Forceps	443	Rosen Lancet Knives	351
Price-Thomas Bronchus Forceps	377	Rosen Raspatories	352
Price-Thomas Forceps	141	Rosenburg Laryngology Tip	312
Probes	23-24, 391	Roser-König Mouth Gag	300

Ross Retractors	223
Roux Retractors	207
Rubbel Bulb	337, 338
Rubin Osteotomes	325
Rubin Septum Forceps	331
Rudd Hemorrhoidal Ligator	417
Rulers	5
Rumel Forceps	131
Rumel-Belmont Tournique	388
Ruskin Bone Cutting Forceps	535
Ruskin Bone Rongeurs	531, 532
Russ. Model Forceps	91
Russel-Davis Tongue Blades	302
Rust Amputation Saws	483
Rydel-Seiffer Tuning Forks	336
Ryder -Vascular Needle Holders	278
S	
Saalfeld Comedone Extractors	22
Sachs Dissectors	288
Sachs Nerve Hook	291
Saenger Ovum Forceps	457
Safety Pin for ring instruments	184
Salenius Meniscus Knives	537
Salpingograph	447
Sami Forceps	108, 109
Samii Tumor Knives	396
Santulli Clamps	145
Sanvenero Scissors	51
Sarot Forceps	130
Sarot Needle Holders	249, 268
Satinsky Clamps	145, 165
Satinsky Scissors	55
Satterlee Amputation Saw	484
Sauerbruch Bone Rongeurs	533
Sauerbruch Retractors	196
Sauerbruch Rib Shears	360, 361
Sauerbruch-Frey Rib Shears	361
Scalp Clips	284
Scalp-Contour Retractors	225
Scalpel Blades	12
Scalpel Handles	9,10
Scalpels	12-19
Schädel Towel Forceps	183
Schamberg Comedone Extractor	22
Scheinmann Laryngology Tips	312
Scherback Specula	434
Schink Dermatome	20
Schmeden Nasal Forceps	476
Schmid Needles	28
Schmid Vascular Spatula	386
Schmieden Guiding Probes	260
Schmieden-Dick Needles	256
Schmieden-Taylor Scissors	56
Schnidt Forceps	120
Schoemaker-Loth Scissors	67
Schoenborn Trachea Retractor	314
Schröder Fistula Knives	17
Schröder Tenaculum Forceps	440, 441
Schröder Uterine Scoops	451
Schubert Biopsy Forceps	448
Schuhmacher Biopsy Forceps	449, 450
Schuhmacher Laryngology Tip	312
Schulze Salpingograph	447
Schumacher Umbilical Scissors	41
Scissors	33-69
Scissors, wound edges	36
Scoville Bone Curettes	520
Scoville Nerve Root Retractors	290
Scoville Retractors	292
Scraper	353
Scudder Intestinal Clamps	407
Sebileau Elevator	508
Sedillot Raspatory	504
Segond Myotome	17
Segond-Landau Forceps	134
Sellheim Obstetrics Lever	455
Sellors Rib Contractor	374
Selman Forceps	91
Semb Bone Cutting Forceps	536
Semb Bone Holding Forceps	523
Semb Bone Rongeurs	533
Semb Bronchus Forceps	377
Semb Raspatories	505
Semken Forceps	89, 94, 112, 113
Semm Vaginal Specula	427
Senn-Green Hooks	221
Senning Needle Holders	268
Senn-Miller Hooks	221
Septum Forceps	329, 330
Septum Instruments	320-332
Septum Knives	320
Septum Scissors	331
Sequestrum Forceps	522
Setting Forceps	143
Sewall Elevators	323
Sexton Myringotomes	344
Seyffert Vaginal Specula	428
Shaaf Forceps	103
Shambough Micro Needles	353
Shapleigh Ear Loops	340
Sharp Hooks	392
Shea Bone Curettes	355
Sickle Knives	320, 351
Silver Dermatome	20
Simon Bone Curettes	519
Simon Hooks	220
Simon Retractors	206
Simpson Obstetrical Forceps	454
Sims Rectal Speculas	414
Sims Scissors	38-39, 72
Sims Uterine Curettes	452
Sims Uterine Depressor	439
Sims Uterine Probes	439
Sims Vaginal Specula	429
Sims-Siebold Scissors	39
Sinuscopy Trocar	26
Skene Tenaculum Forceps	441
Skin Trephines	21
Skull Punch	287
Skull Traction Tongs	286
Sluder-Balenger Tonsilotome	308
Smillie Meniscus Knives	538
Smillie Meniscus Retractors	538
Smith Bandage Scissors	556
Smith Scissors	83
Smith-Petersen Chisel	497
Smith-Petersen Gouges	497
Smithwick Applying Forceps	285
Smithwick Nerve Hooks	291
Sommer Uterine Forceps	444
Spare Blades	309
Spare Snares	307
Special Needles	28
Spencer Scissors	66
Spencer-Wells Forceps	118
Spine Retractors	292-296
Splinter Forceps	103-104, 570
Sponge Forceps	173-176
Spongiosa Gouges	500-501
Spratt Bone Curettes	518

Spurling Rongeurs	478	Tobald Tongue Depressor	299
Stacke Probe	23	Toennis Dissectors	387
Standard Trocars	26	Toennis Dura Knives	19, 290
Stellbrink Bone Rongeurs	528	Toennis Forceps	119, 125
Sterilization products	579-581	Toennis Needle Holders	276
Sterilizing Forceps	571	Toennis Nerve Hook	291
Sternberg Lip Retractor	303	Toennis Scissors	48
Sternum Chisel	360	Toennis-Adson Scissors	48, 78
Stethoscopes	3	Tohoku Towel Forceps	183
Stevens Scissors	53	Tongue Depressors	299-303
Stieglitz Splinter Forceps	570	Tongue Holding Forceps	303
Stille Bone Cutting Forceps	535	Tonsil Forceps	476
Stille Bone Rongeurs	532	Tonsil Holding Forceps	304
Stille Chisel	493	Tonsil Instruments	304-309
Stille Forceps	87, 93, 140	Tonsil Knives	18, 306
Stille Gouges	494	Tonsil Needles	28
Stille Osteotomes	493	Tonsil Retractors	308
Stille Plaster Scissors	560	Tonsil Scissors	49-50, 79
Stille-Barraya Forceps	97	Tonsil Snares	306, 307
Stockmann Penis Seizing Forceps	462	Tonsil Suture Needles	308
Stomach Intestinal Instruments	400-418	Tonsilotome	307
Stone Forceps	98	Tourniquets	388
Strabismus Scissors	47, 53	Towel Forceps	182, 183
Strabismus Scissors	53	Toynbee Ear Specula	339
Strandell-Stille Hooks	222	Trachea Instruments	313-314
Stratte Needle Holders	271	Trachea Retractors	218, 219
Strauss Penis Seizing Forceps	462	Traction Hooks	541
Struck Rib Spreaders	369	Trélat Vaginal Specula	428
Struempel Ear Polypus Forceps	343	Trigeminal Knives	18
Strully Scissors	55	Trocars	26
Struycken Rongeurs	480	Troemner Percussion Hammer	2
Subramanian Forceps	147	Tróltsch Forceps	101
Suction Tubes	30-32	Trousseau Trachea Dilator	313
Suture Hook	388	Troutman-Christ Blade Holder	11
Suture Instruments	245-280	Tubbs Dilator	384
Suture Sets	262	Tubing Clamps	184
Suture Tying Forceps	105, 106	Tübingen Retractors	206
Sweden Pattern Forceps	86	Tübinger Modell Retractors	227
Sweet Applying Forceps	285	Tuffier Grasping Forceps	181
Swivel Knives	324	Tuffier Rib Spreaders	367
Synovectomy Rongeurs	528	Tumor Knives	396
Sypert Punches	473	Tuning Forks	335, 336
T		Turnbull Nail Cutter	569
Tabb Mukosa Knife	351	Tuttle Forceps	91
Takahashi Nasal Forceps	477	Twisting Forceps	543-546
Tamper	490	Tyding Tonsil Snare	307
Tampon and Polypus Forceps	319	U	
Taylor Forceps	89, 94, 95, 112	Ulrich Bone Holding Forceps	524
Taylor Meniscus Retractor	539	Ulrich Dressing Forceps	173
Taylor Percussion Hammers	2	Ulrich Fistula Knife	17
Taylor-Brown Forceps	97	Umbilical cord Scissors	41
TC Needle Holder	264-280	Universal Bandage Scissors	559
TC-Forceps	116-114	Universal Cotton Applicators	24
TC-Scissors	69-83	Universal Scissors	67, 83
TC-Twisting Forceps	543, 545	Universal Sterilizing Forceps	571
TC-Wire Cutter	545	Universal Trocar	26
TC-Wire Cutting Forceps	545	Unna Comedone Extractors	22
Teale Tenaculum Forceps	442	Unna-Vidal Comedone Extractor	22
Tenaculum Forceps	440-443	Urethral Bougies	463
Tendon Interlacing Forceps	539	Uterine Curettes	452
Tendon Seizing Forceps	539, 540	Uterine Depressors	439
Terrier Forceps	127	Uterine Dilators	436-438
Thoms-Gaylor Biopsy Forceps	449	Uterine Elevating Forceps	444
Thorax Instruments	358-377	Uterine Probes	439
Thorek Scissors	47, 78	Uterine Scoops	451
Tieck-Halle Nasal Specula	316	V	
Tissue Forceps	92-98	Vaccination Lancet	5
Tissue Grasping Forceps	175-181	Vaginal Forceps	134-136
Tissue Picks	392	Vaginal Specula	427-434
Titanium Bulldog Clamps	144		

Vaginal Spreader	435	Wire Saws	484
Van Buren Bone Holding Fcps.	523	Wire Tightener	541, 542
Van Doren Biopsy Forceps	449	Wire Traction Bows	541
Vannas Scissors	59, 65	Wires	552
Varicose Vein Probe Set	381	Wisconsin-Foregger Laryngoscopes	7,8
Vascular Dilators	383, 384, 391	Wolff Lupus Scraper	21
Vascular Instruments	380-397	Wolff Plaster Breakers	561
Vascular Needle Holders	277-279	Wound Clips	262
Vascular Scissors	55-58	Wound Suture Instruments	262
Vascular Spatulas	386	Wrench	541
Veidenheimer Anastomosis Clamps	412	Wullstein Ear Polypus Forceps	343
Vein Needle	28	Wullstein Retractors	226
Verbrugge Bone Holding Fcps.	525	Wullstein Suction Tubes	30
Vernet Hooks	221		
Verres Needles	28	Y	
Vessel Spreader	391	Yankauer Suction Tubes	31
Vickers Bone Rongeurs	528	Yasargil Forceps	107-109
Vidal Lupus Scraper	21	Yasargil Galea Hooks	284
Virchow Brain Knife	16	Yasargil Micro Raspatory	395
Virchow Scalpel	15,16	Yasargil Micro Scoop	395
Vise Forceps	105	Yasargil Needle Holders	254
Volkmann Bone Curettes	518, 520	Yasargil Rongeurs	480
Volkmann Retractors	188, 189	Yasargil Scissors	65
Vollmar Needles	28	Yasargil Suction Tubes	31
Vollmar Ring Strippers	382	Yasargil Suture Pusher	392
Voltolini Nasal Specula	316	Yeoman Biopsy Forceps	418
Von Eicken Suture Needle	308	Young Prostatic Retractors	215
		Young Tongue Holding Forceps	303
W		Young-Millin Suture Instruments	261
Wachenfeldt Suture Forceps	262		
Wagner Ear Hooks	342	Z	
Wagner Hooks	216	Zaufal Bone Rongeurs	531
Wagner Scissors	52, 53, 80	Zaufal Ear Elevator	341
Waldmann Scissors	40, 73	Zenker Forceps	129
Walsham Septum Forceps	330	Zenker Retractors	194
Walter Osteotomes	325	Ziegler Dura Knife	19
Walter Retractor	327	Zweifel Needle Holders	276
Wangensteen Forceps	91, 113		
Wangensteen Needle Holder	251, 272		
Wartenberg Pinwheel	4		
Watson-Williams Nasal Forceps	477		
Wagh Forceps	92		
Weber Forceps	153		
Webster Needle Holders	250, 269		
Wecker Scissors	59		
Weder Tongue Depressors	299		
Weil Nasal Forceps	477		
Weil-Blakesley Nasal Forceps	475		
Weissbarth Vaginal Specula	434		
Weitlaner Retractors	225-228		
Wertheim Forceps	134-136		
Wertheim Scissors	39, 42		
Westcott Scissors	64		
White Tonsil Holding Forceps	304		
Whitehead Mouth Gag	300		
Wiener Model Specula	431		
Wiener Rasps	516		
Wilde Forceps	101		
Williger Bone Curettes	517, 518		
Williger Elevators	508		
Williger Mallets	487		
Williger Raspatories	501		
Winter Ovum Forceps	456		
Wire closure Forceps	348		
Wire Cutter	545, 546		
Wire Cutting Forceps	545, 546		
Wire cutting Scissors	67, 83		
Wire dispenser	552		
Wire Extension	541-547		
Wire for cerclage	542		
Wire for Snares	345		



**Berger Surgical
Medical Products GmbH
Kirchstraße 22
D - 78532 Tuttlingen**

Germany

Telefon: +49 (0) 74 61/96 96-0
Telefax: +49 (0) 74 61/96 96-20
www.berger-surgical.de
info@berger-surgical.de